

The **BIG** Book of **ALPHABET** Activities

A Treasure Trove of Engaging Activities, Mini-Books, and Colorful Picture Cards for Teaching Alphabet Recognition, Letter Formation, and More!

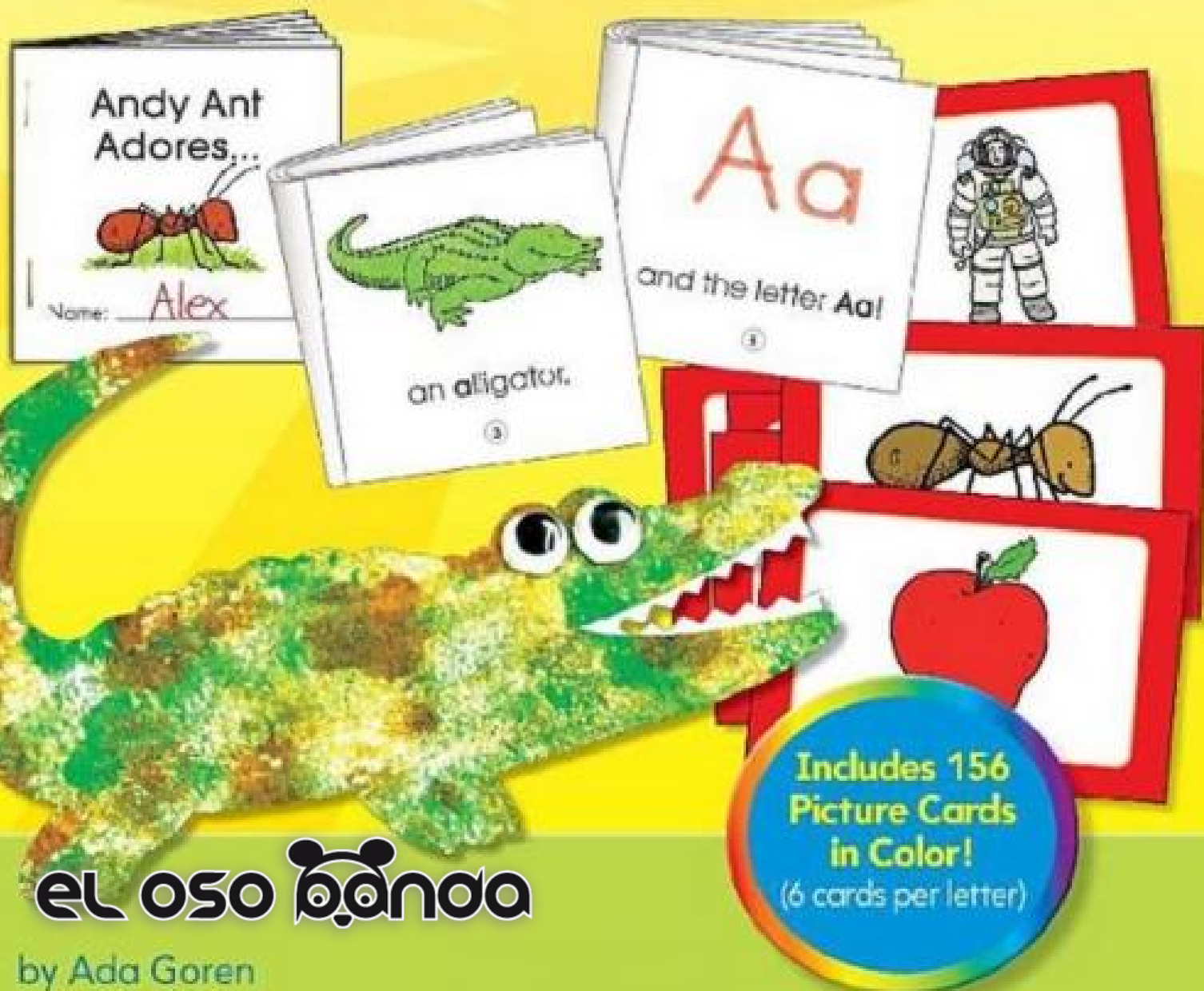

el oso banda

by Ada Goren

 SCHOLASTIC

Grades PreK–K

The **BIG** Book of
ALPHABET
Activities

by Ada Goren

New York • Toronto • London • Auckland • Sydney
Mexico City • New Delhi • Hong Kong • Buenos Aires

Teaching
Resources



To my wonderful and supportive friends!

Scholastic Inc. grants teachers permission to photocopy the reproducible pages from this book for classroom use. No other part of this publication may be reproduced in whole or in part, or stored in a retrieval system, or transmitted in any form or by any means, electronic, mechanical, photocopying, recording, or otherwise, without written permission of the publisher. For information regarding permission, write to Scholastic Inc., 557 Broadway, New York, NY 10012-3999.

Edited by Immacula A. Rhodes

Cover design by Maria Lilja

Interior design by Holly Grundon

Cover and interior illustrations by Maxie Chambliss and Kate Flanagan

ISBN-13: 978-0-545-13576-4

ISBN-10: 0-545-13576-1

Copyright © 2010 by Ada Goren

Illustrations © 2010 by Scholastic Inc.

Published by Scholastic Inc.

All rights reserved.

Printed in China.

Contents

About This Book 4
 What's Inside 4
 Using the Full-Color Alphabet Picture Cards 6
 Meeting the Language Arts Standards 8

Alphabet Lessons

Letter Aa 9
 Letter Bb 15
 Letter Cc 22
 Letter Dd 28
 Letter Ee 34
 Letter Ff 42
 Letter Gg 48
 Letter Hh 53
 Letter Ii 59
 Letter Jj 64
 Letter Kk 69
 Letter Ll 74
 Letter Mm 79
 Letter Nn 86
 Letter Oo 92
 Letter Pp 98
 Letter Qq 105
 Letter Rr 109
 Letter Ss 115
 Letter Tt 121
 Letter Uu 129
 Letter Vv 134
 Letter Ww 141
 Letter Xx 147
 Letter Yy 152
 Letter Zz 158

Writing Practice Pages 164

Full-Color Alphabet Picture Cards 177

Storage Label last page

About This Book

The alphabet is one of the most important things for children to learn—knowledge of letters and their sounds is key to learning to read and write. Young children need practice with recognizing both uppercase and lowercase letters, identifying and writing those letters, and understanding letter-sound associations. When you provide children practice with these skills, you help open the door to literacy!

In his book *Phonics From A to Z* (Scholastic, 2006, revised), reading specialist Wiley Blevins notes that the two best predictors of early reading success are alphabet recognition and phonemic awareness (Adams, 1990; Stanovich, 1992; Chall, 1996; Beck and Juel, 1995; Share, Jorm, Maclean, and Matthews, 1984). These two skills—knowing the letters and the sounds they represent and being able to identify these sounds with automaticity—are essential for early reading development.

The BIG Book of Alphabet Activities is a resource full of ideas to help you incorporate alphabet recognition and practice in letter-sound associations into your entire school day, so that children get maximum exposure to these skills. The units—one for each letter of the alphabet—can be used in alphabetical order or any sequence that meets the needs of your class. Activities include practice and reinforcement in recognizing and identifying letters, forming and writing the uppercase and lowercase versions of letters, and making the connection between letters and their sounds. The easy-to-implement ideas motivate children of all learning styles and can be used during center time, math time, story time, snack time, or anytime to help build letter knowledge and meet important language arts standards. (See Meeting the Language Arts Standards, page 8.) In addition, reproducible patterns are provided to help make your planning and prep work easier.

What's Inside

Each alphabet lesson in *The BIG Book of Alphabet Activities* includes an activity for the following:

- ❖ **Introducing the Letter**—Suggestions for introducing the target letter and its sound are provided at the beginning of the letter lesson. Six full-color picture cards per letter are included in the back of this resource, starting on page 177. The pictures can be used during the introductory activity as well as throughout the lesson to help reinforce children's letter knowledge. (See Using the Full-Color Alphabet Picture Cards, page 6, for more.)

- ❖ **Math**—While the focus of the lesson is letter learning, we know you have to teach important math skills, too. The math activity helps you connect and reinforce a letter-related skill while giving children practice with a particular math skill—such as counting, patterning, or nonstandard measurement. Think of it as multitasking!
- ❖ **Craft**—Art is a fun and creative component of a young child’s school day. The craft activity incorporates the letter being studied and provides a natural and easy way to make the craft even more meaningful.
- ❖ **Game**—The game provides specific practice with the target letter. Games throughout this book are both fun and practical and use a variety of formats—card games, relay races, memory, lotto, and more—to reinforce letter recognition and letter-sound skills.
- ❖ **Movement**—Gross motor activities give young children a chance to work out their wiggles and build their bodies. You’ll find a physical development activity linked to each letter lesson to engage your active learners while building their letter knowledge.
- ❖ **Snack**—Your school day probably includes a snack time, so why not work letter learning into every moment that you can? The snack idea will tempt children’s taste buds and help them learn the alphabet at the same time!
- ❖ **Literature**—A book selection is provided to help you make a literature connection to the feature letter. After reading the story to children, use the follow-up activity to further reinforce children’s knowledge of the letter or its sound.

Preparing to Teach the Letter Lessons

- ❖ Cut apart the picture cards for the letter you wish to teach.
- ❖ Make a class supply of the corresponding mini-book patterns.
- ❖ Duplicate a class supply of the writing practice page for that letter.
- ❖ Review the activities and prepare materials for those you want to use.
- ❖ Have fun with letter learning!

Snack Tips

- ❖ Check for food allergies ahead of time.
- ❖ If cooking is required, be prepared to provide close adult supervision.
- ❖ Have children wash hands before preparing and eating their snack.

- ❖ **Letter Mini-Book**—Use the reproducible mini-book to give children additional letter-sound practice. After they assemble and read their mini-book in class, children can take it home to read again and again.

In addition to a lesson for each of the 26 letters, *The BIG Book of Alphabet Activities* also includes a Writing Practice Page specifically designed to give children practice in forming the target letter. Turn to page 164 to find reproducible pages that provide handwriting lines sized just right for beginning writers to practice writing the uppercase and lowercase versions of each letter of the alphabet.

Making the Mini-Book

1. Cut apart the pages.
2. Sequence the pages and stack them behind the cover.
3. Staple the pages together at the top left corner.
4. Write your name on the cover. Color the picture on each page and trace the letter on page 5.

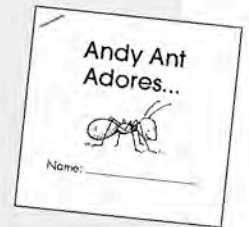

Using the Full-Color Alphabet Picture Cards

Six colorful picture cards for each letter of the alphabet can be found on pages 177–253. Simply pull out the pages with the desired cards, cut the cards apart, laminate for durability, and the cards are ready for use. (You might glue the cards to tagboard before laminating to make them sturdier.) The cards provide a great basis for letter-sound learning as you introduce each letter. They can also be used for reinforcement throughout your letter study as well as for periodic reviews of the letters children have already learned. Some additional ways you can use the picture cards follow on page 7.





Letter Match-Up: Choose one picture card from each of several letter sets. Gather letter flashcards or magnetic letters that correspond to the chosen pictures. Put the letters and picture cards in a center. To use, have children match the letters to the pictures that begin with the corresponding sounds.

ABC Order: Select one picture card from each of the 26 card sets. Place those cards in a center, along with a pre-printed alphabet strip. (Or write the alphabet across the length of a sentence strip.) Have children match each picture to its beginning letter by laying the card next to the letter on the strip. Challenge them to find the matches for all 26 letters.

Toss and Tell: Take one picture card from each of several letter sets and spread the cards out on the floor in an open area. If desired, tape the cards in place. Then invite children to take turns standing behind a taped line and tossing a beanbag toward the cards. When the beanbag lands on a card, have children name the picture and its beginning letter.

Letter-Sound Memory: Choose two pictures from each of several letter sets. Lay out the cards facedown in a grid pattern. Then have a pair of children play a game similar to Memory, taking turns flipping over two cards at a time to try to find two pictures that begin with the same letter sound. If children find a match, they keep the cards. If not, they flip the cards back over. The child with the most matches at the end of the game is the winner.

Which Doesn't Belong?: Display three or four cards from the same letter set in each row of a pocket chart. Then add one card from a different letter set to each row. Place the "odd" letter card in a different position in each row. Then invite children to name the pictures in each a row and identify the one that begins with a different letter sound.

Pocket-Chart Match: Choose two picture cards from each of several letter sets. Display one card from each pair in the left column of a pocket chart. Display the remaining cards—in random order—in the right column of the chart. To use, have children take each picture card from the right side and match it next to the picture on the left that begins with the same letter sound.

Storage

For quick and easy storage of the cards, simply cut out, laminate, and attach the handy label (page 255) to the front of a clasp envelope or the top of a storage box.



Meeting the Language Arts Standards

Connections to the McREL Language Arts Standards

The activities in this book are designed to support you in meeting the standards listed below for students in grades preK–K. These standards have been outlined by Mid-continent Research for Education and Learning (McREL), an organization that collects and synthesizes national and state PreK-12 curriculum standards and suggests what teachers should provide for their students to help them become proficient in language arts, among other curriculum areas.

Uses the general skills and strategies of the reading process including:

- knows uppercase and lowercase letters of the alphabet
- Uses basic elements of phonetic analysis (e.g., understands sound-symbol relationships; beginning and ending consonants, vowel sounds) to decode unknown words

Uses grammatical and mechanical conventions in written compositions including:

- Uses conventions of print in writing (e.g., forms letters in print, uses uppercase and lowercase letters of the alphabet)

Kendall, J. S. & Marzano, R. J. (2004). *Content knowledge: A compendium of standards and benchmarks for K-12 education*. Aurora, CO: Mid-continent Research for Education and Learning. Online database: <http://www.mcrel.org/standards-benchmarks/>

Connections to Early Childhood Language Arts Standards

The activities in this book are also designed to support you in meeting the following PreK-1 literacy goals and recommendations established in a joint position statement by the National Association for the Education of Young Children (NAEYC) and the International Reading Association (IRA)*:

- Understands that print carries a message
- Engages in reading and writing attempts
- Recognizes letters and letter-sound matches
- Begins to write

* *Learning to Read and Write: Developmentally Appropriate Practices for Young Children*, a joint position statement of the International Reading Association (IRA) and the National Association for the Education of Young Children (NAEYC). <http://www.naeyc.org/about/positions/pdf/PSREAD98.PDF> © 1998 by the National Association for the Education of Young Children

Introducing Aa

Before beginning your study of the letter *Aa*, remove the picture cards that begin with this letter (pages 177 and 179). Cut apart and laminate the cards for durability. Then write an uppercase and lowercase *A* on the chalkboard, or display a large letter card. Show children each picture card. As you name the picture, emphasize its beginning sound. Then point to and name the letter *A* on the board. Have children repeat the word and the sound of the *A* at the beginning of the word. After reviewing, keep the cards on display and use them throughout your letter study.

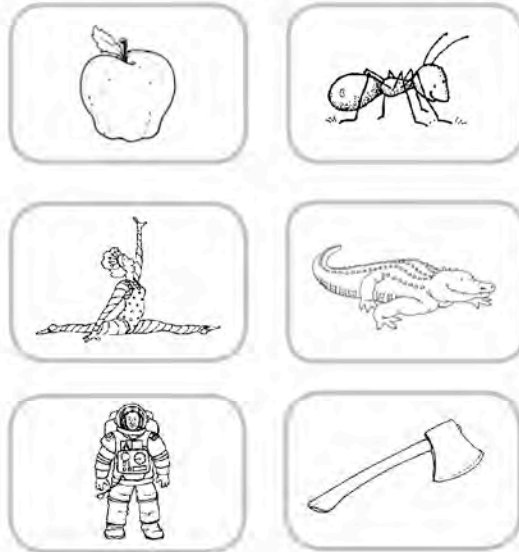

Math

A Is for Ants

Count on ants to help children learn the letter *A*! Duplicate several sets of the ant counters on page 12 and cut them apart. (If desired, copy the counters onto tagboard and laminate them.) Give each child in a small group a set of the ant counters. Ask children to say the word *ants* and name the beginning letter of the word. When they respond with “*A*,” have them use their counters to form an uppercase *A*. Next, tell children that they will count out a specific number of ants and try

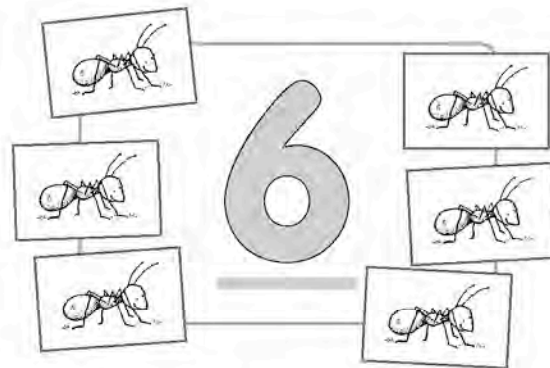

to form the letter *A* with that quantity. Then give children a number card between 1 and 10 and ask them not to show it to the group. Have them count out a corresponding number of their ant counters. When everyone is ready, recite the verse below several times, each time naming a different child and inviting that child to count his or her ants aloud for the group. Afterward, challenge children to try to form the letter *A* with their number of ants. Can they do it? Why or why not?

Little ants, little ants, 1, 2, 3...
 [Child’s name], count your ants for me!

Craft

A Is for Alligator

Let everyone in your school know what letter children are working on by displaying these critter crafts. Have children sponge-paint a 9- by 12-inch sheet of white construction paper with green and brown tempera paint. Allow the paint to dry. Give children tagboard tracers of the alligator pattern (page 13) to trace on the back of their sponge painting. Have them cut out their alligator. Then invite children to trim one long edge of two ½- by 2-inch strips with zigzag craft scissors. Help them tape or glue the teeth to the back of their gator's mouth opening so that the zigzag edges resemble teeth. Finally, have them glue on two wiggle eyes. Display the completed alligators on your classroom door or a hallway bulletin board with the title, "A Is for Alligators!"

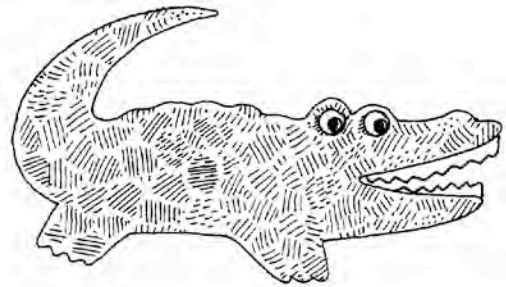

Game

A Is for "Aaa-choo!"

Use this game to help children focus on the short sound of the beginning letter A. First, give children a tissue and have them practice making a fake sneeze with a resounding "Aaa-choo!" Have children listen for the short A sound at the beginning of the sneeze. Next, tell them that you will say some words that begin with different sounds. When they hear a word that begins with short A, they should sneeze an "Aaa-choo!" as a signal. If a word begins with a different sound, they should remain silent.

Some words that begin with A:

apple
astronaut
ask
after
avenue
alligator
ant
addition

Movement

A Is for Acrobats

Encourage children to play the part of circus acrobats warming up for a preschool-perfect performance! To do this, lead them in some "acrobat antics," having children follow along as you touch your toes, twist side to side, or lie on your back and bicycle your legs in the air. Then divide your class into groups of three. Have each group of acrobats use their bodies to form the letter A.

Snack

A Is for Apples

You can't study the letter A without eating apples! How about a kid-friendly version of apple pie? Give children a refrigerator biscuit and three peeled apple wedges on a paper plate. Have them flatten their biscuits, lay apple wedges on top to form the letter A, and then sprinkle a bit of cinnamon-sugar on top. Bake the "pies" according to the biscuit package directions. Cool and enjoy!



Literature

A Is for The Apple Pie Tree

Prepare to follow up a reading of Zoe Hall's *The Apple Pie Tree* (Blue Sky Press, 1996) by creating a large, simple tree shape from green and brown construction paper. Use poster adhesive to mount the tree on a wall within children's reach. Then duplicate a supply of the apple cards (page 12) on red construction paper and cut them out. Label some of the apples with an uppercase or lowercase A, and the rest with other letters. After sharing the story, do the following letter-recognition activity with small groups: Give each child an apple card. Then invite children to take turns showing the apple to the group and telling whether or not the letter on it is an A. If it is, children attach their apple to the tree with removable adhesive. If not, they put the apple aside. Continue until the group finds all of the apples labeled with A or a.

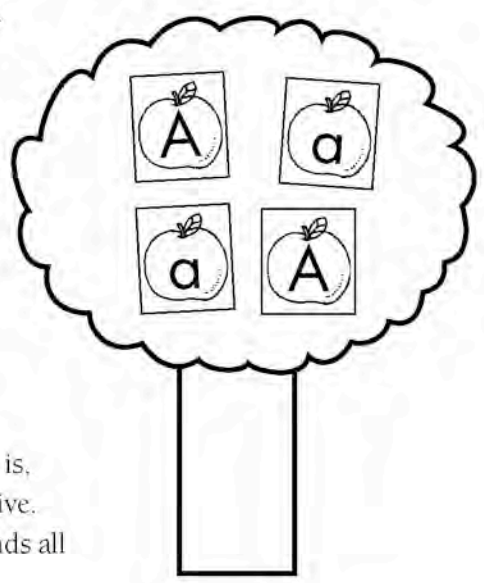

Letter Aa Mini-Book

Reinforce children's knowledge of the letter A and their letter-writing skills with this mini-book. First, duplicate a class supply of the mini-book patterns (page 14). Ask children to color the cover and pages, write their name on the cover, and trace the letters on page 5. Then have children cut apart the pages, stack them in order behind the cover, and staple the mini-book together in the upper left corner. Read the mini-book aloud as a class, emphasizing the beginning short sound of A in the appropriate words. Then send the mini-books home for children to share with their family.

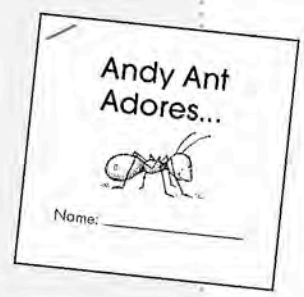

Aa

A B C D E F G H I J K L M

Ant Counters

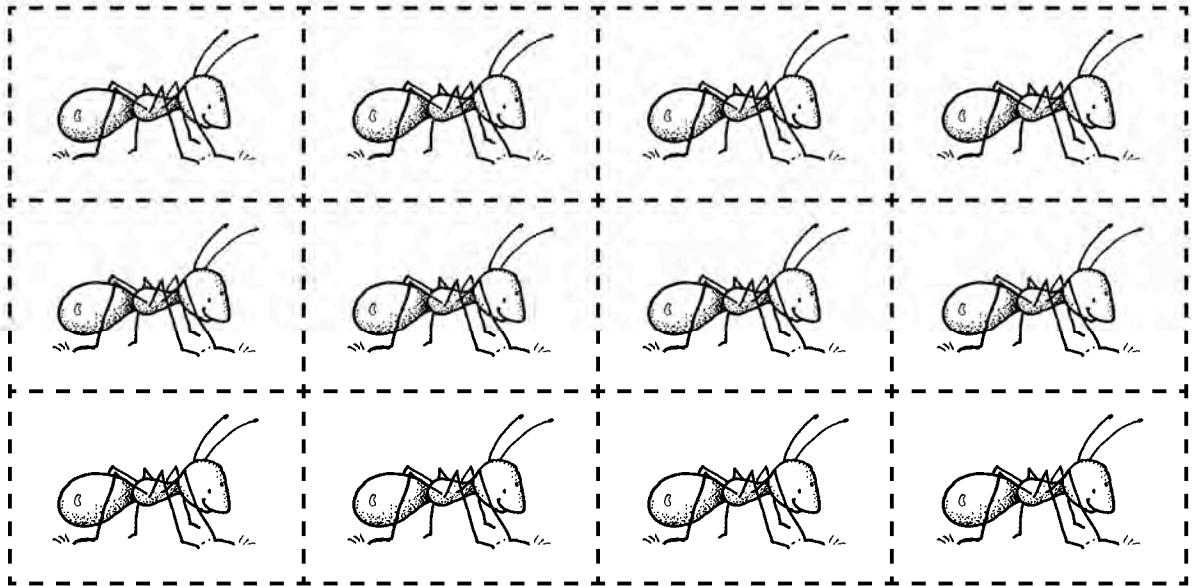

Apple Cards

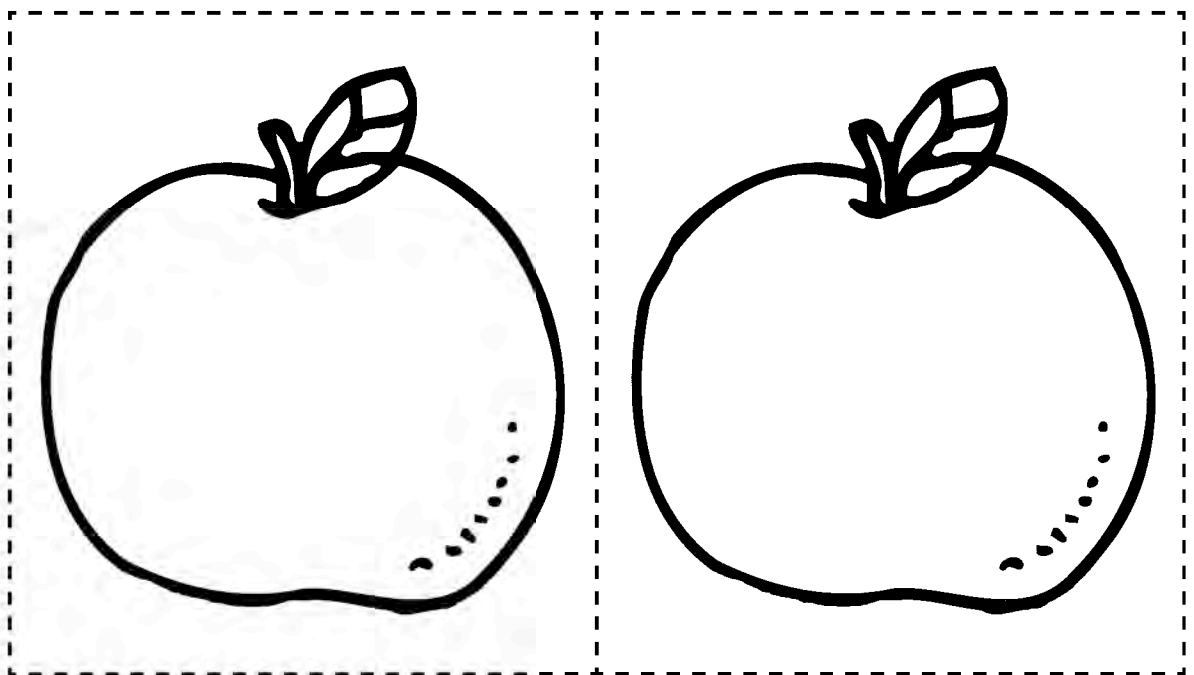

Aa

Alligator
Pattern



Andy Ant Adores...

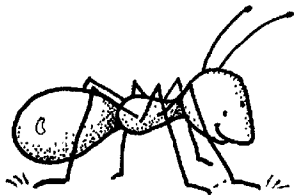

Name: _____

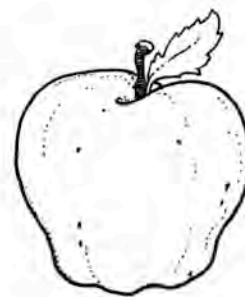

an **apple**,

1

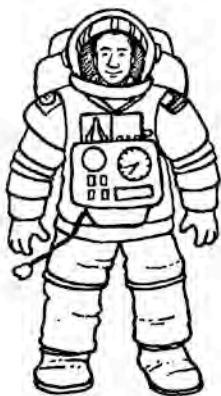

an **astronaut**,

2

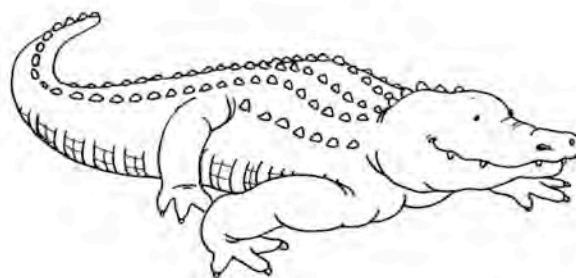

an **alligator**,

3



an **acrobat**,

4



and the letter **Aa!**

5

Introducing Bb

Before beginning your study of the letter *Bb*, remove the picture cards that begin with this letter (pages 179 and 181). Cut apart and laminate the cards for durability. Then write an uppercase and lowercase *B* on the chalkboard, or display a large letter card. Show children each picture card. As you name the picture, emphasize its beginning sound. Then point to and name the letter *B* on the board. Have children repeat the word and the sound of *B* at the beginning of the word. After reviewing, keep the cards on display and use them throughout your letter study.

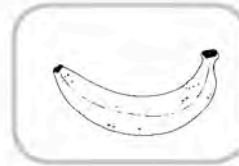

Math

B Is for Beanbags

Children can practice their tossing, counting, and letter skills with this small-group activity. Give children three beanbags each. First, ask them to combine their beanbags and arrange them to form an uppercase *B*. Remind them that *beanbag* starts with this letter. Then have children take their beanbags and stand at a designated point around a goal, such as a large basket or a plastic hoop. Invite them to take turns tossing their beanbags toward the goal and counting aloud the number the group successfully gets inside. Children can gather their beanbags and try again until they get all the beanbags inside the goal. Repeat the activity for more counting practice.

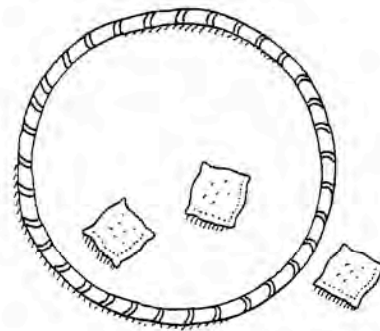

Craft

B Is for Bat

Have children flap on over to the art area to make these black bats. To prepare for each child, tape a 9- by 12-inch sheet of clear Con-Tact® vinyl covering sticky-side-up on a table (remove the backing). Give children two small green or yellow sticky dots to place color-side-down near the center of the vinyl sheet. Then have them cover the vinyl with black construction-paper or tissue-paper squares. When finished, help children press a second vinyl sheet of the same size on top of the paper-covered sheet. Next, have them trace a tagboard tracer of the bat pattern (page 18) onto one side of the pressed sheets, making sure the head is centered over the sticky dots (which will serve as the bat's eyes). Finally, help children cut out the shape. To display, hang the bats in your classroom windows or from the ceiling.

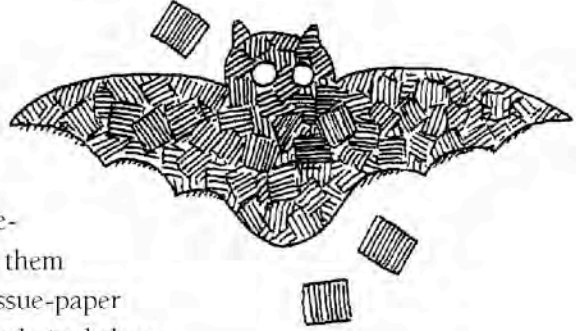

Game

B Is for Ball

Challenge children to identify words that begin with the sound of *B* when you play this game. First, have children stand in a semicircle around you. Then toss a small playground ball to the first child in the circle and say a word. If the word begins with the sound of *B*, the child tosses the ball back to you. If the word starts with a different sound, the child holds the ball and continues holding it while you say additional words. When the child identifies a word that starts with *B*, he or she tosses the ball back to you. Continue around the circle until everyone has had a turn.

Some words that begin with *B*:

book
balloon
bed
banana
butterfly
biscuit

Movement

B Is for Bubbles

Get children up and moving with a round of the "Bubble Boogie!" Play some lively recorded music as you blow bubbles into the air. Invite children to dance and pop bubbles until you stop the music. Then invite a few children to name words that begin with the letter *B*. Restart the music, bubble blowing, and dancing before pausing again for more *B* words.

Snack

B Is for Bagels With Butter

This snack does a “bee-autiful” job of reinforcing the letter *B*! Give children a sheet of paper with a vertical rectangle drawn down the left side (as shown). This will serve as a placemat. Then give children a mini bagel that has been split in half to make two curved sections, a dab of soft butter, and a plastic knife. Have them spread butter on each bagel half and then arrange the bagels (butter side up) next to the rectangle to form an uppercase *B*. Invite them to eat the bagel that makes the top part of the *B* first. Then point out that the remaining bagel and rectangle now form a lowercase *b*!

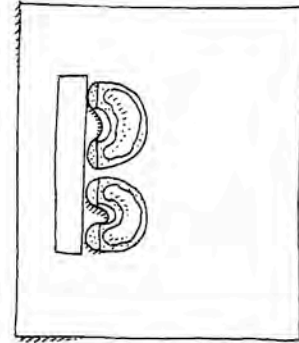

Literature

B Is for King Bidgood's in the Bathtub

Prepare this activity to follow a reading of Don and Audrey Wood’s hilarious tale *King Bidgood’s in the Bathtub* (Harcourt Children’s Books, 1985). Duplicate the bathtub and bubble patterns (pages 19–20) onto white construction paper. Cut out the patterns, laminate them, and prepare them for use on your flannelboard. Then read the story aloud. Afterward, working with one small group at a time, review the words *bubbles* and *bathtub*. Point out that both words begin with the letter *B*. Display the bathtub on your flannelboard. Then ask children to sort the bubbles, naming each picture and placing only the ones that begin with the *B* sound in the tub.

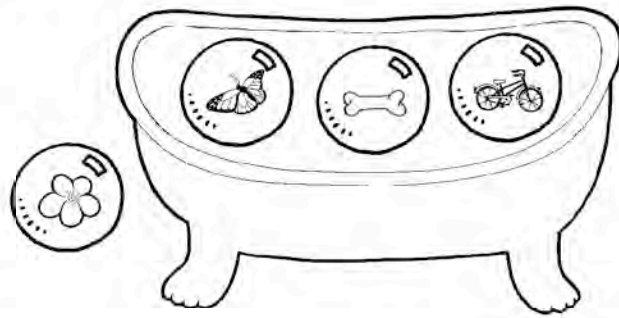

Letter Bb Mini-Book

Reinforce children’s knowledge of the letter *B* and their letter-writing skills with this mini-book. First, duplicate a class supply of the mini-book patterns (page 21). Ask children to color the cover and pages, write their name on the cover, and trace the letters on page 5. Then have children cut apart the pages, stack them in order behind the cover, and staple the mini-book together in the upper left corner. Read the mini-book aloud as a class, emphasizing the beginning sound of *B* in the appropriate words. Then send the mini-books home for children to share with their family.

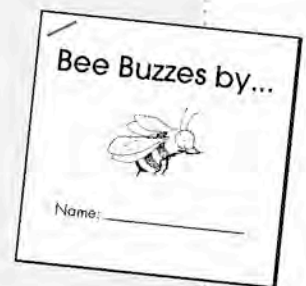

Bb

A B C D E F G H I J K L M

Bat Pattern

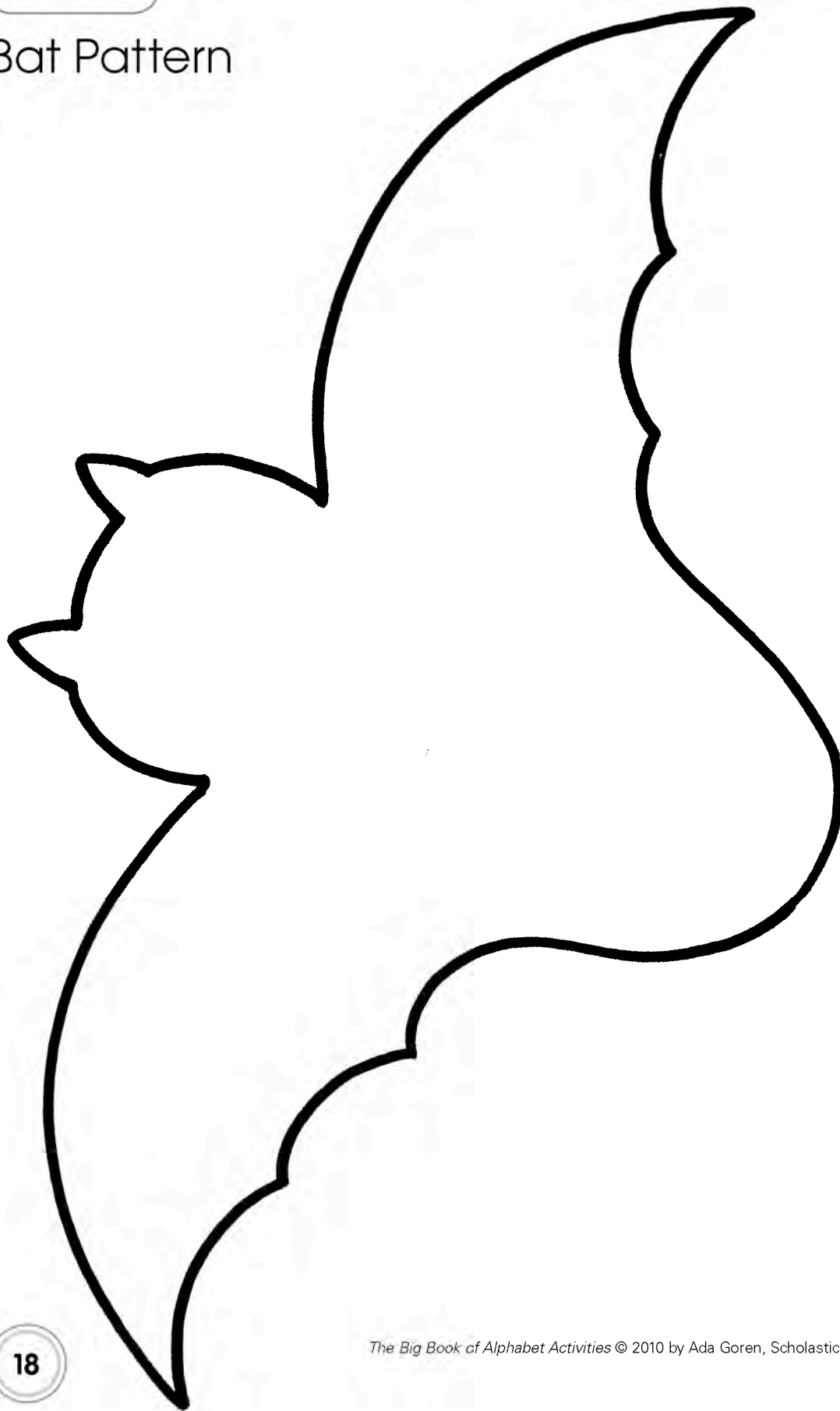

Bathtub Pattern

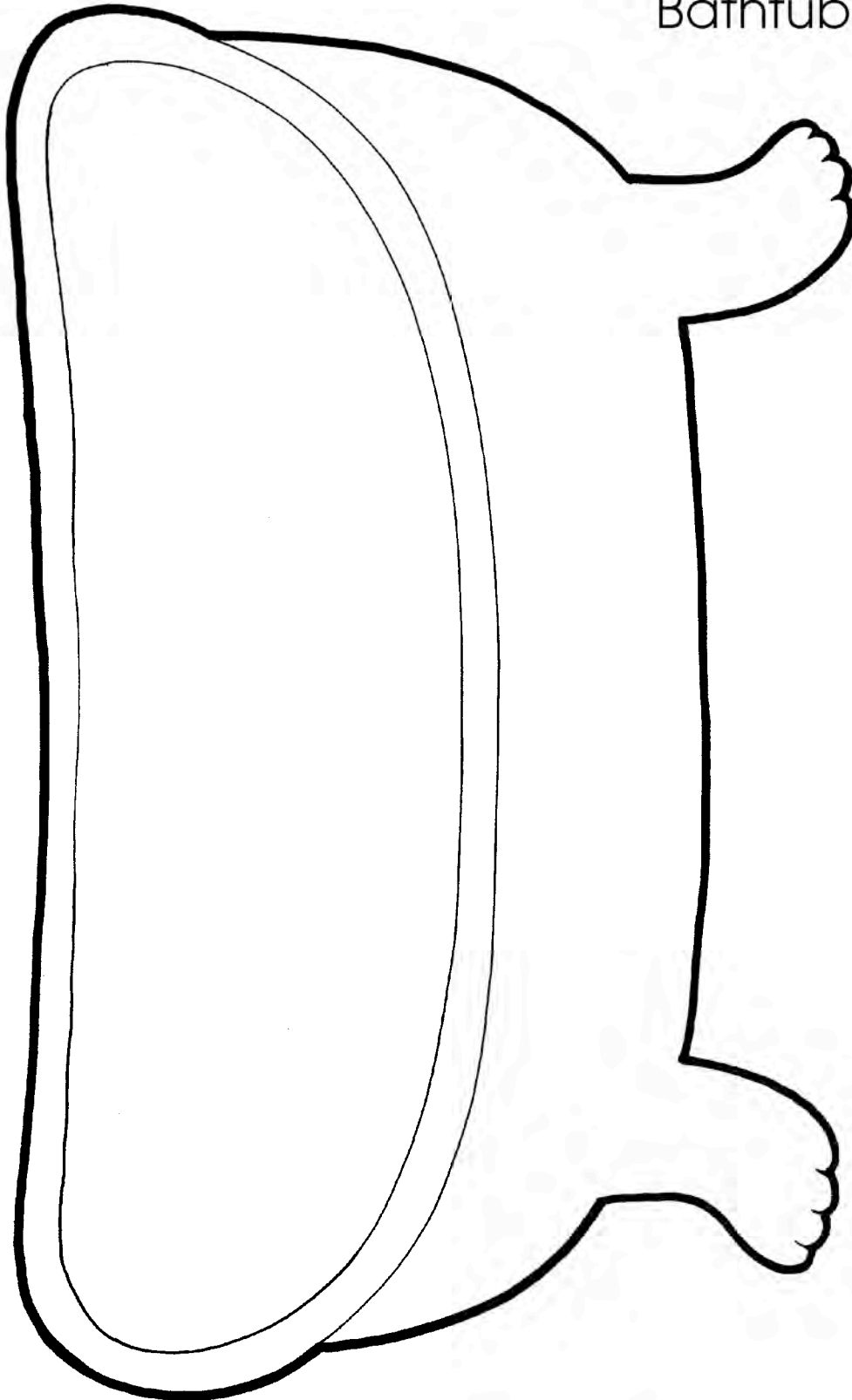

Bb

A B C D E F G H I J K L M

Bubble Patterns

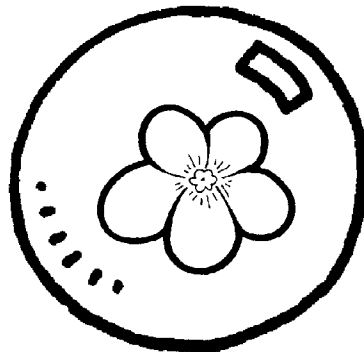
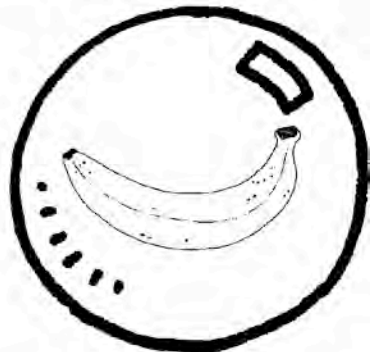
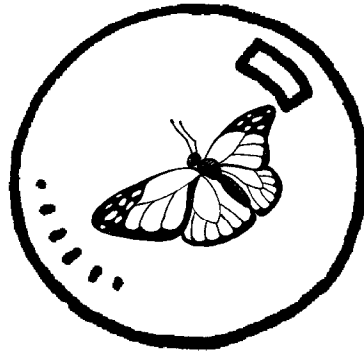
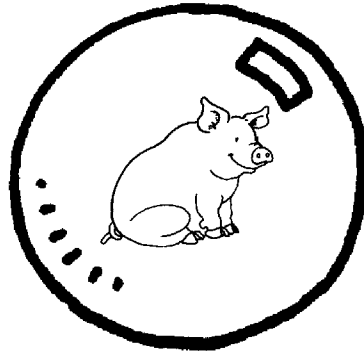
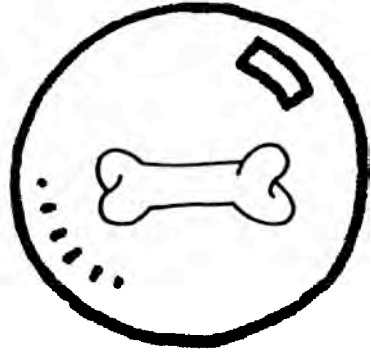

Bee Buzzes by...

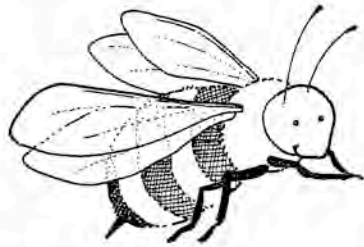

Name: _____



a **b**ell,

1



a **b**anana,

2



a **b**utterfly,

3



a **b**ear,

4



and the letter **Bb**!

5

Introducing Cc

Before beginning your study of the letter Cc, remove the picture cards that begin with this letter (pages 183 and 185). Cut apart and laminate the cards for durability. Then write an uppercase and lowercase C on the chalkboard, or display a large letter card. Show children each picture card. As you name the picture, emphasize its beginning sound. Then point to and name the letter C on the board. Have children repeat the word and the sound of C at the beginning of the word. After reviewing, keep the cards on display and use them throughout your letter study.

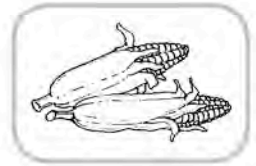
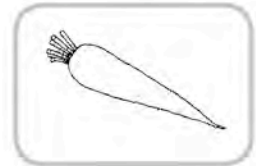

Math

C Is for Cars

Rev up number recognition with this activity. In advance, divide a sheet of poster board into parking spaces for some of your toy cars. Mark the spaces randomly with numbers you want children to learn to recognize. Also, use masking tape to outline a letter C on the floor. Gather a few toy cars and a small group of children to begin the activity. Ask children to take turns driving a toy car over the outline of the letter C and then parking the car in the space marked with a given number. Continue the activity until each child has had a turn to park a car. Then direct children to switch parking spaces with each other to provide additional practice in number recognition.

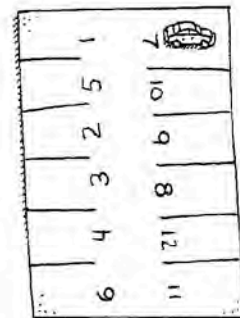
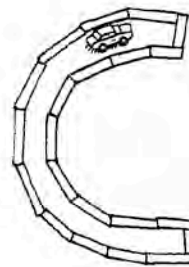

Craft

C Is for Caterpillar

The letter C abounds with this crafty and colorful caterpillar painted with carrots! To prepare, set out a few 6-inch foam plates, each with a small amount of tempera paint in the color of your choice. Cut a few carrots in half at the middle and add a carrot half to each plate. Then give children a half-sheet of white construction paper. Ask them to choose a paint color and dip the flat, cut end of the carrot into the paint. Then have them press the carrot onto their paper—near the bottom—to make a round carrot print. Tell children to continue stamping carrot prints, making the circles touch (but not overlap), to form a caterpillar. Invite them to use and alternate colors as they wish. After the paint dries, have children add facial features, antennae, and legs to their caterpillar. They might also add a sky, grass, and other details to their picture.

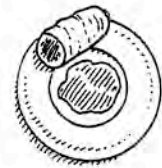
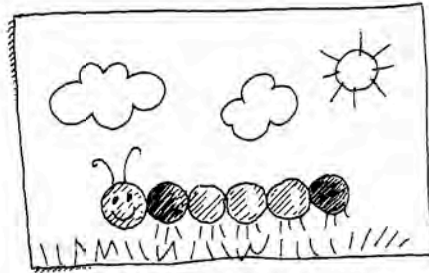

Game

C Is for Camera

Picture this—a game that helps children find photos of things that begin with the sound of C! To prepare, duplicate the photo cards on page 25. Color and cut apart the cards, then laminate them for durability, if desired. Place the cards all around your classroom where children can find them. Pair up children and invite one pair at a time to play the game. To play, the two children hold toy or pretend cameras as they walk around the room in search of the photo cards. Each time children find a card, they say, “Click!” and then name the picture and take the card. The child with the most photo cards at the end of a predetermined time is the winner!

Movement

C Is for Coach

Exercising will be lots of fun when children take turns being Coach and calling the plays! Invite one child at a time to take the role of “Coach” and instruct their “team” of classmates on which exercises to perform. For example, Coach might lead exercises such as jumping jacks, toe touches, or running in place. For children’s last call as Coach, have them instruct the team to form their bodies into the shape of the letter C.

Snack

C Is for Carrots and Cucumbers

Use some veggies that begin with *C* to give children practice in forming uppercase and lowercase versions of this letter. In advance, peel a few carrots and cucumbers and slice them into rounds. Then give children several slices of each vegetable on a sheet of waxed paper. Invite them to use the cucumbers to make an uppercase *C* and the carrots to make a lowercase *c*. Ready? Crunch!

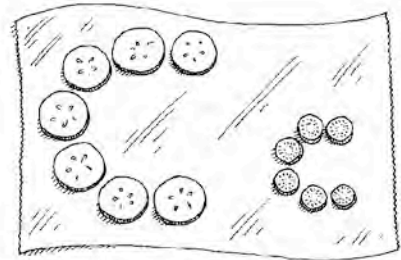

Literature

C Is for If You Give a Cat a Cupcake

After reading aloud Laura Numeroff's *If You Give a Cat a Cupcake* (HarperCollins, 2008), have children complete this activity focused on words that begin with the sound of *C*. Point out to children that both *cat* and *cupcake* begin with the letter *C*. Then give children a copy of the cupcake pattern (page 26). Ask them to decorate the top of their cupcake with a picture of something that starts with the *C* sound, color the cupcake wrapper, and then cut out their completed cupcake. Invite children to show their cupcake to the class.

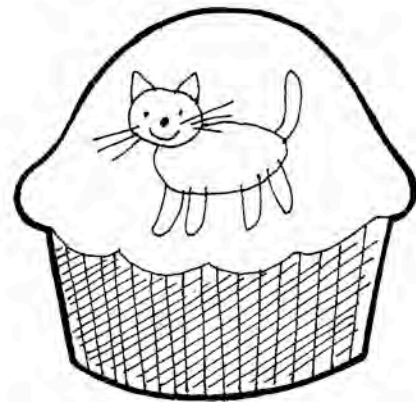
**Letter Cc Mini-Book**

Reinforce children's knowledge of the letter *C* and their letter-writing skills with this mini-book. First, duplicate a class supply of the mini-book patterns (page 27). Ask children to color the cover and pages, write their name on the cover, and trace the letters on page 5. Then have children cut apart the pages, stack them in order behind the cover, and staple the mini-book together in the upper left corner. Read the mini-book aloud as a class, emphasizing the beginning sound of *C* in the appropriate words. Then send the mini-books home for children to share with their family.

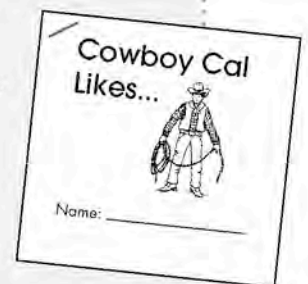

Letter C Photo Cards



Cc

A B C D E F G H I J K L M

Cupcake Pattern

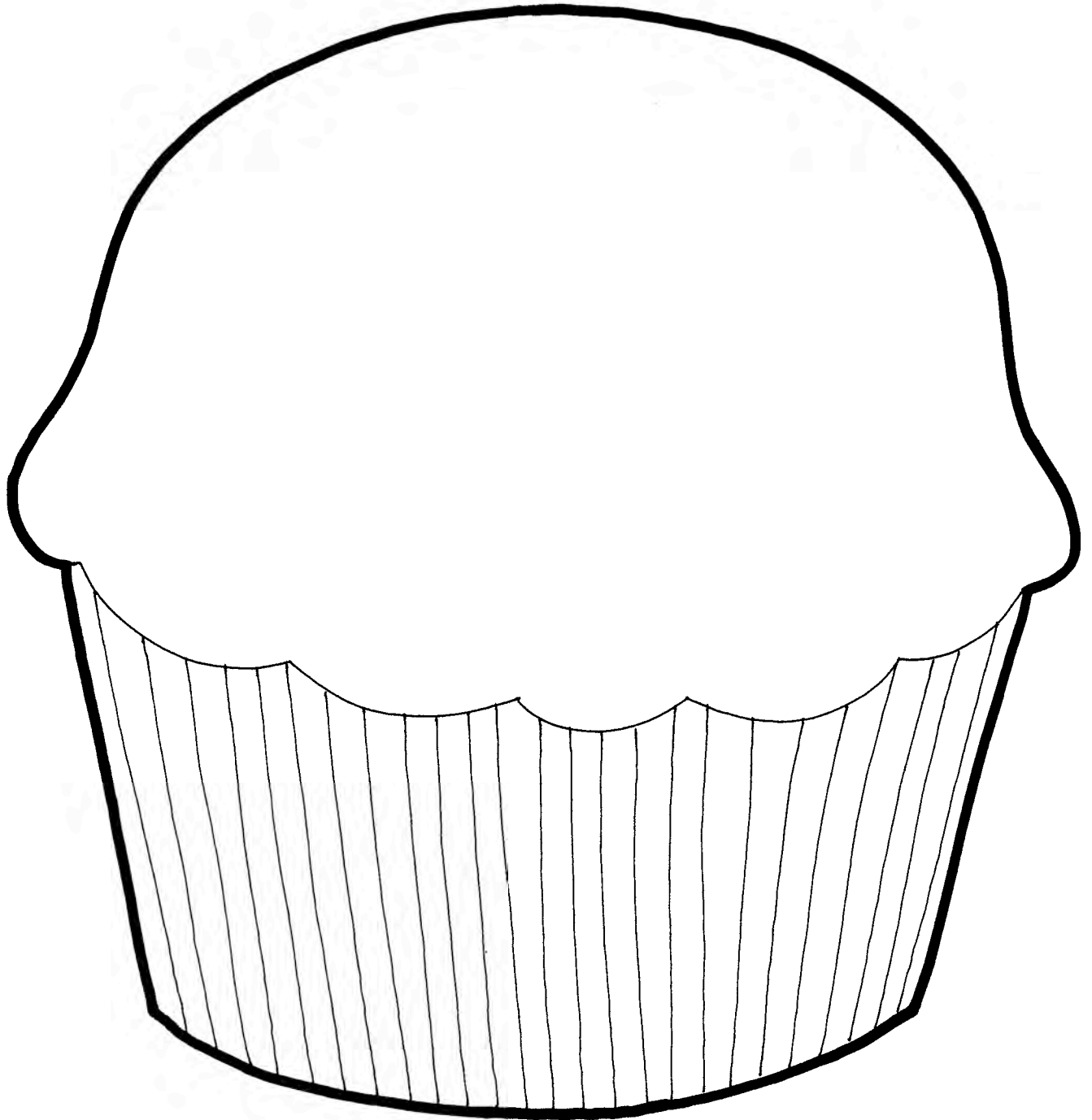

Cowboy Cal Likes...



Name: _____



a **c**arrot,

1



a **c**at,

2

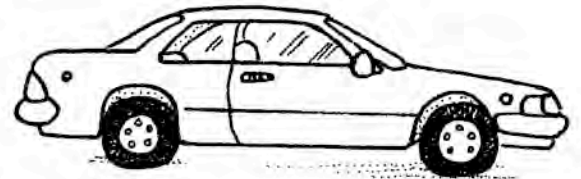

a **c**ar,

3

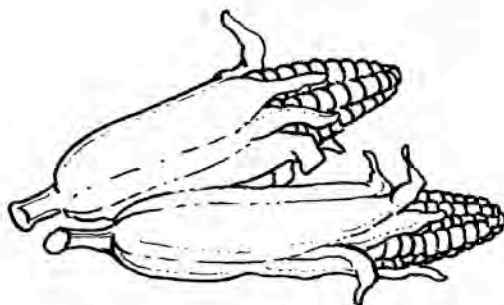

corn,

4



and the letter **Cc**!

5

Introducing *Dd*

Before beginning your study of the letter *Dd*, remove the picture cards that begin with this letter (pages 185 and 187). Cut apart and laminate the cards for durability. Then write an uppercase and lowercase *D* on the chalkboard, or display a large letter card. Show children each picture card. As you name the picture, emphasize its beginning sound. Then point to and name the letter *D* on the board. Have children repeat the word and the sound of *D* at the beginning of the word. After reviewing, keep the cards on display and use them throughout your letter study.

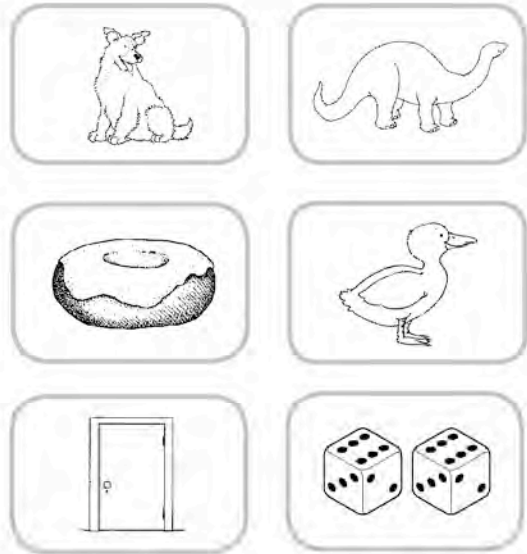

Math

D Is for Dinosaur

To prepare this small-group math activity, make four to six copies of the dinosaur game board on page 31. Label the spikes on each dinosaur with numbers that you want children to recognize. If desired, laminate the game boards for durability. Then cut a supply of construction-paper triangles that match the size and shape of the dinosaur spikes on the game boards. To play with a small group, give each child a game board and several paper spikes. Explain that *dinosaur* begins with *D*. Then call out a number. If children have that number on their game board, they cover it with a paper spike. Continue the game, calling out different numbers as you go along. The first child to cover all of the dinosaur spikes on his or her game board is the winner!

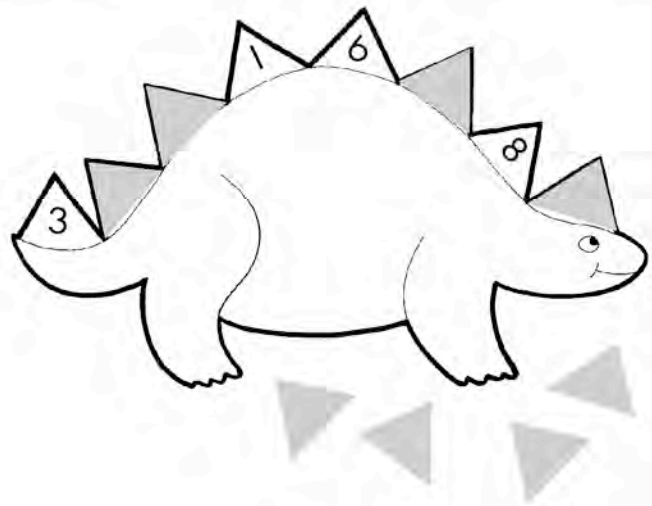

Craft

D Is for Duck

Children will turn the letter *D* into a duck with this project. Duplicate the uppercase and lowercase *D* patterns (page 32) onto white construction paper and the duck feet and beak onto orange construction paper. Have children cut out the patterns, but not the centers of the two letters. Then ask them to paint the bottom of a sheet of light blue construction paper with green tempera paint. Once the paint dries, help children arrange and glue their letter cutouts to the paper, as shown, to create a duck's body, neck, and head. Have them add the beak and feet and then, finally, draw an eye to complete this delightful duck!

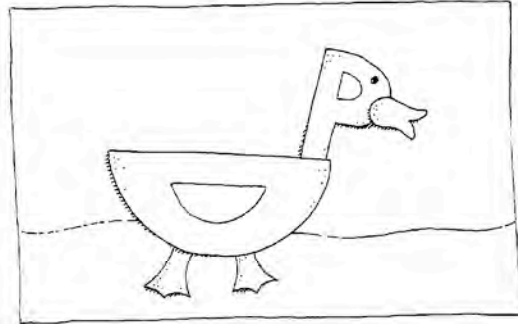

Game

D Is for Door

For this game, ask children to line up at the door to your classroom. Explain that each child must give a word that begins with the letter *D* in order to go through the door and into the hall. As they give their words and pass through the door, have children form another line in the hallway. Then challenge children to name another *D* word to re-enter to the room.

Movement

D Is for a Dozen Doughnuts

The object of this relay race is to get a dozen doughnuts into the box before the other team does. To prepare, cut out 24 doughnut shapes from tagboard. (If desired, enlarge the doughnut from the mini-book pattern on page 33 to use as a pattern.) Write a word that begins with *D* on the back of each doughnut, or glue on a picture of something that begins with *D*. In an open area, set up two stations, placing 12 doughnut cutouts, picture-side-down, near a flat box at each one. Then line up two teams of children—one child behind the other—a few yards away from the two doughnut stations. On a signal, the first child on each team runs to the doughnut station, picks up a doughnut, turns it over and calls out the *D* word or picture, and puts it in the box. Then the child runs back to his or her team, tags the next child in line, and that child takes a turn. Continue until one team gets all 12 doughnuts in its box.

Snack

D Is for Delicious Dip

Children will eat up the letter *D*—literally—with this snack! Add some milk to a mild-flavored vegetable dip to thin it out. Then put the dip in a squeeze bottle. Next, cut carrots and celery into thin sticks. At snack time, help children squeeze some dip onto a paper plate, forming the letter *D* with the dip. Then invite them to dip a few carrot and celery sticks in the dip as they devour their *D*-licious snack!

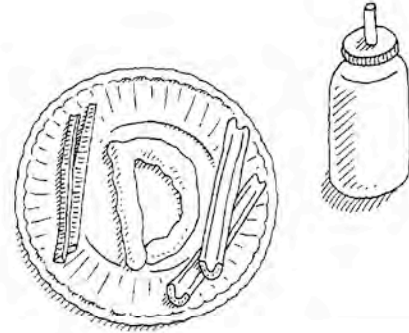

Literature

D Is for Harry, the Dirty Dog

After hearing *Harry, the Dirty Dog* (HarperCollins, 1976) by Gene Zion, children can make their own white dogs that will grow dirtier and dirtier as they listen for words that begin with the letter *D*. Give each child a thin white paper plate and two ear shapes that have been precut from white construction paper. Have children glue the ears to the plate and draw a face on the plate to create a dog's head. Then ask children to take out a black crayon and listen as you say some words. Each time they hear a word that begins with letter *D*, they will add a black smudge to their white dogs.

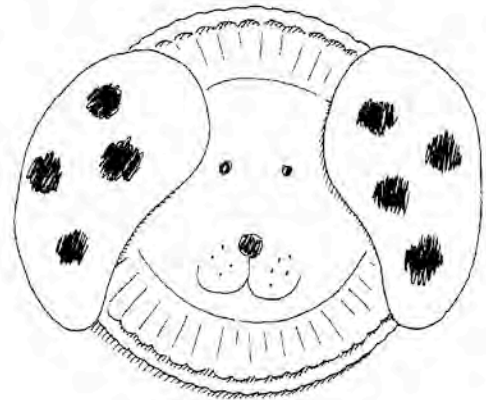
**Letter Dd Mini-Book**

Reinforce children's knowledge of the letter *D* and their letter-writing skills with this mini-book. First, duplicate a class supply of the mini-book patterns (page 33). Ask children to color the cover and pages, write their name on the cover, and trace the letters on page 5. Then have children cut apart the pages, stack them in order behind the cover, and staple the mini-book together in the upper left corner. Read the mini-book aloud as a class, emphasizing the beginning sound of *D* in the appropriate words. Then send the mini-books home for children to share with their family.

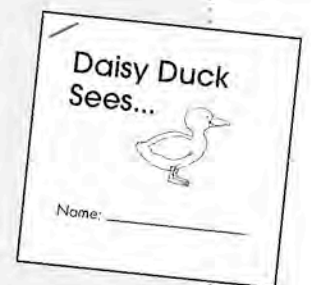

Dd

Dinosaur
Game Board

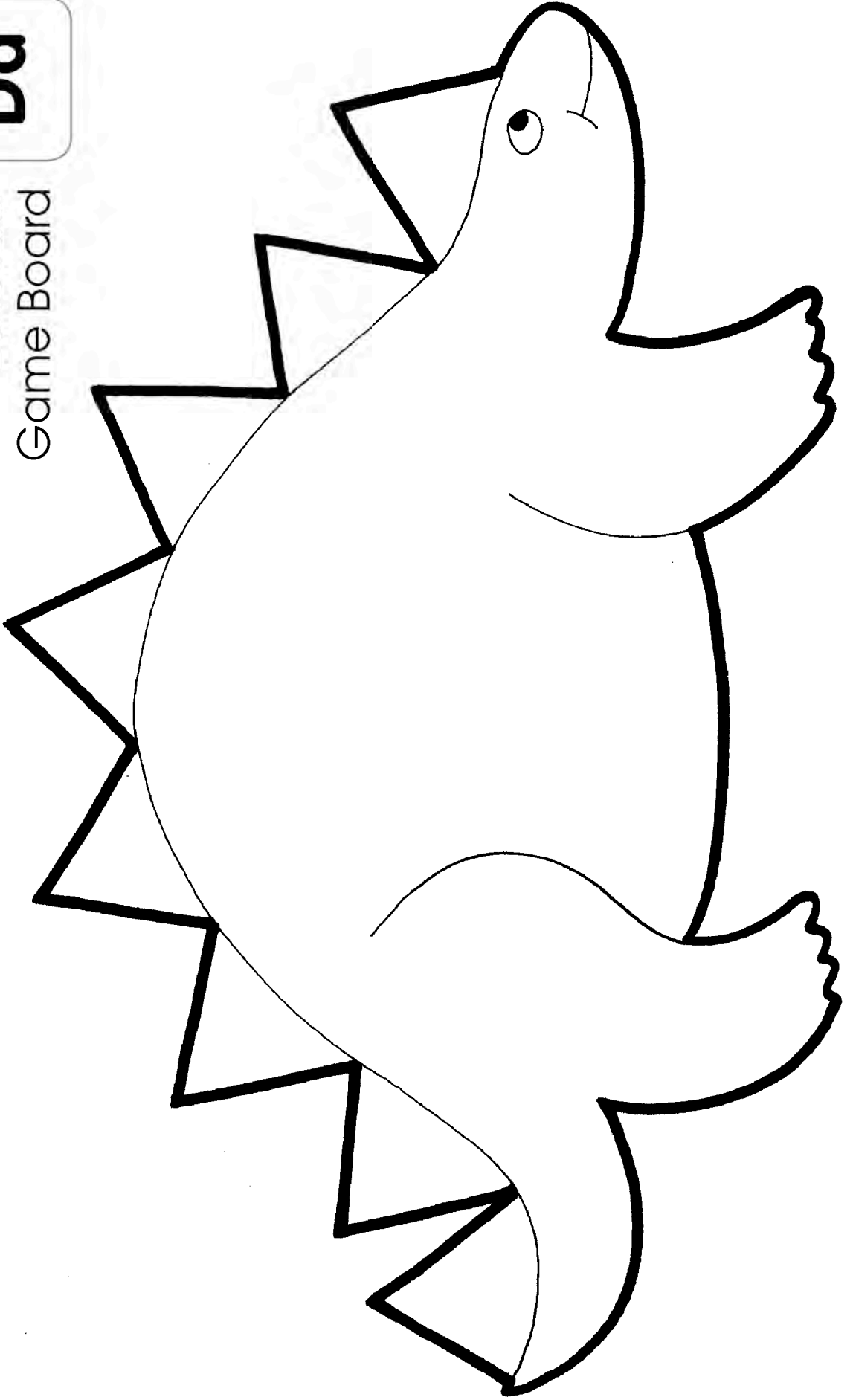

Dd

A B C D E F G H I J K L M

Dd and Duck Patterns

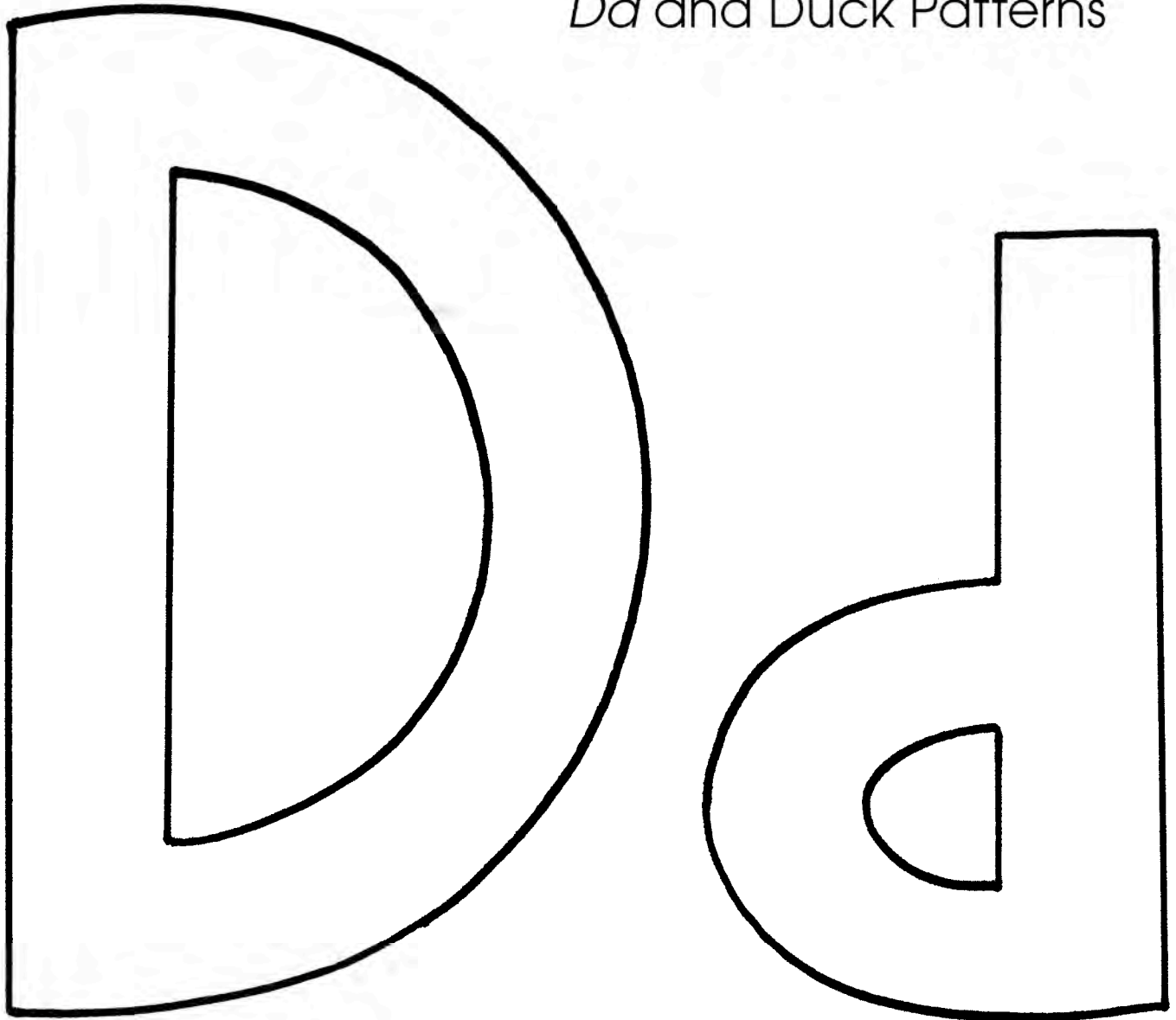

beak



feet

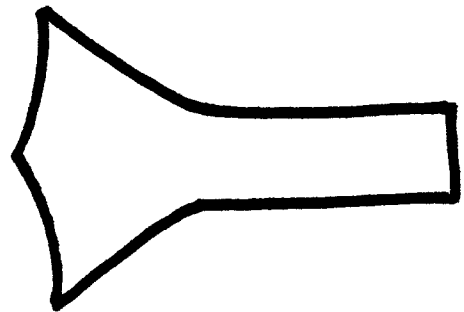
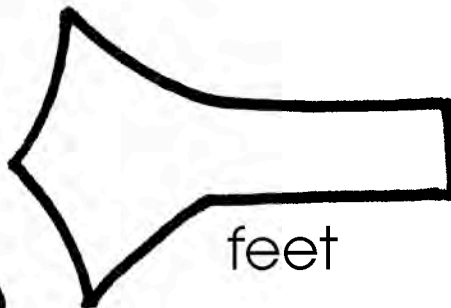

Daisy Duck Sees...

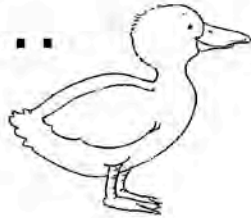

Name: _____



a **dog**,

1

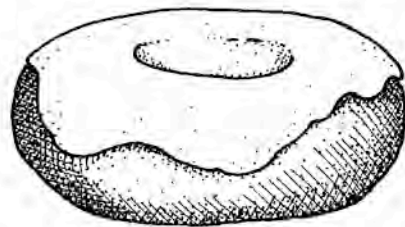

a **doughnut**,

2

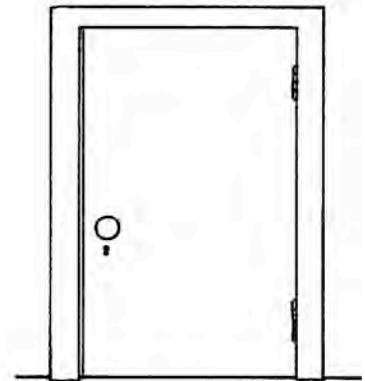

a **door**,

3

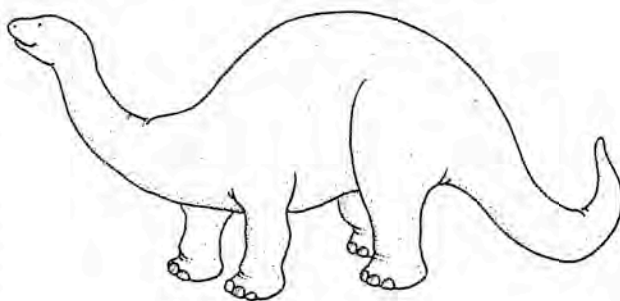

a **dinosaur**,

4



and the letter **Dd**!

5

Introducing *Ee*

Before beginning your study of the letter *Ee*, remove the picture cards that begin with this letter (pages 189 and 191). Cut apart and laminate the cards for durability. Then write an uppercase and lowercase *E* on the chalkboard, or display a large letter card. Show children each picture card. As you name the picture, emphasize its beginning sound. Then point to and name the letter *E* on the board. Have children repeat the word and the sound of *E* at the beginning of the word. After reviewing, keep the cards on display and use them throughout your letter study.

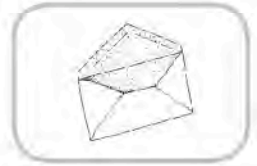
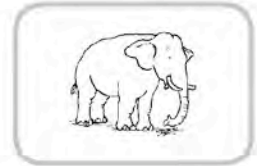
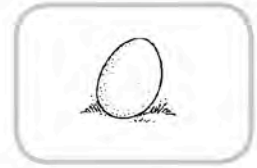

Math

E Is for Envelopes

Prepare for this activity by cutting out a supply of basic shapes you want children to learn to identify. Put each shape inside a separate envelope. Then seat children in a circle on the floor. Show them the envelopes and point out that *envelope* begins with an *E*. Next, ask a few children to arrange some of the envelopes on the floor to form an uppercase *E*. Then play some recorded music and begin passing the envelopes around the circle. Each time you stop the music, ask those children who are holding an envelope to open it, take out the shape, and name that shape for the group. Have them return their shape to the envelope and then restart the music to continue the activity.

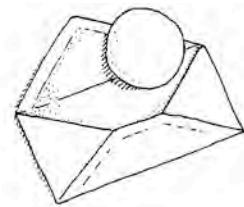

Craft

E Is for Elf

Everyone will love these cute little elves! To prepare, duplicate the elf head and ear patterns (page 37) onto construction paper in a variety of flesh tones and the two hat patterns (page 38) onto two different colors of construction paper. To make an elf, children cut out their elf and hat patterns and glue them together, as shown. Then they add a pom-pom to the tip of the hat and draw a face for their elf. Display the completed elves on a door or bulletin board with the title, “*E* Is for Elves!”



Game

E Is for Egg Hunt

Emphasize the sound and shape of the letter *E* with a small-group egg hunt! In advance, label some small slips of paper with an uppercase *E* and others with a lowercase *e*. Put each slip inside a separate plastic egg, then hide the eggs around the room, checking that they are partially visible. To start the hunt, ask a child to listen to two words: one that begins with the short *E* sound, and one that does not. Have the child identify the short *E* word. Then invite the child to search the room for an egg and hold onto it. After each child in the group has had a turn, ask children to open their eggs and identify the letter inside. Then have them sort the letters into two groups—uppercase and lowercase *E*. If there are more eggs to find, repeat the activity to give children additional practice.

Some words that begin with *E*:

echo
edge
exciting
elf
elm
everyone
elephant
elevator

Movement

E Is for Elbows

Children will mix laughter and fun with exercise when they perform this action poem!

Point your elbows to the sky.
See if you can jump up high!

Now point your elbows at the ground.
Hold them there and turn around.

Arms to the side, elbows straight—
Kick your legs and count to eight.

Hands go up and elbows bend.
Tap your head and count to ten.

Now glue your elbows to your sides.
Wave your hands and say, "Goodbye!"



Snack

E Is for Easy Egg Salad

Here's a super-simple way to make egg salad! For each child, put a peeled, hard-boiled egg and ½ teaspoon of light mayonnaise in a disposable foam or paper bowl. Then distribute sturdy plastic forks to children and have them mash their eggs and mayonnaise together. Invite them to add a sprinkle of salt and pepper to their mixture if they wish. Children can eat their easy egg salad straight from the bowl or spread it on an English muffin half. As they enjoy their snack, point out that egg begins with an *E*. Mmm...excellent!

Literature

E Is for Elmer

With this story activity, children make their own version of the patchwork elephant in David McKee's *Elmer* (HarperCollins, 1989). Make tagboard tracers of the elephant pattern on page 39. Then duplicate a class supply of the letter grid (page 40) onto green construction paper. Give children a grid and seven 1¼-inch squares in each color: red and purple. Tell them to glue a red square over each square on the letter grid that is labeled with an uppercase *E*. Then have them glue a purple square over each lowercase *e*. Once the glue dries, ask children to place an elephant tracer on top of the colorful grid and trace the outline. Help them cut around the outline to create a patchwork elephant. If desired, invite children to use a black marker to draw facial features on their elephant.

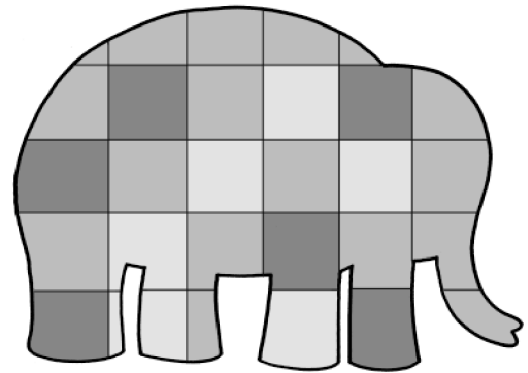
**Letter Ee Mini-Book**

Reinforce children's knowledge of the letter *E* and their letter-writing skills with this mini-book. First, duplicate a class supply of the mini-book patterns (page 41). Ask children to color the cover and pages, write their name on the cover, and trace the letters on page 5. Then have children cut apart the pages, stack them in order behind the cover, and staple the mini-book together in the upper left corner. Read the mini-book aloud as a class, emphasizing the beginning sound of *E* in the appropriate words. Then send the mini-books home for children to share with their family.

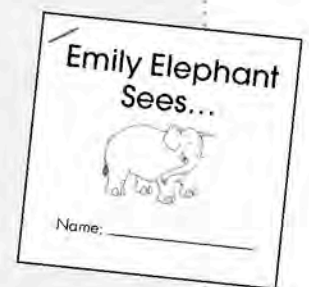

Elf Patterns

head

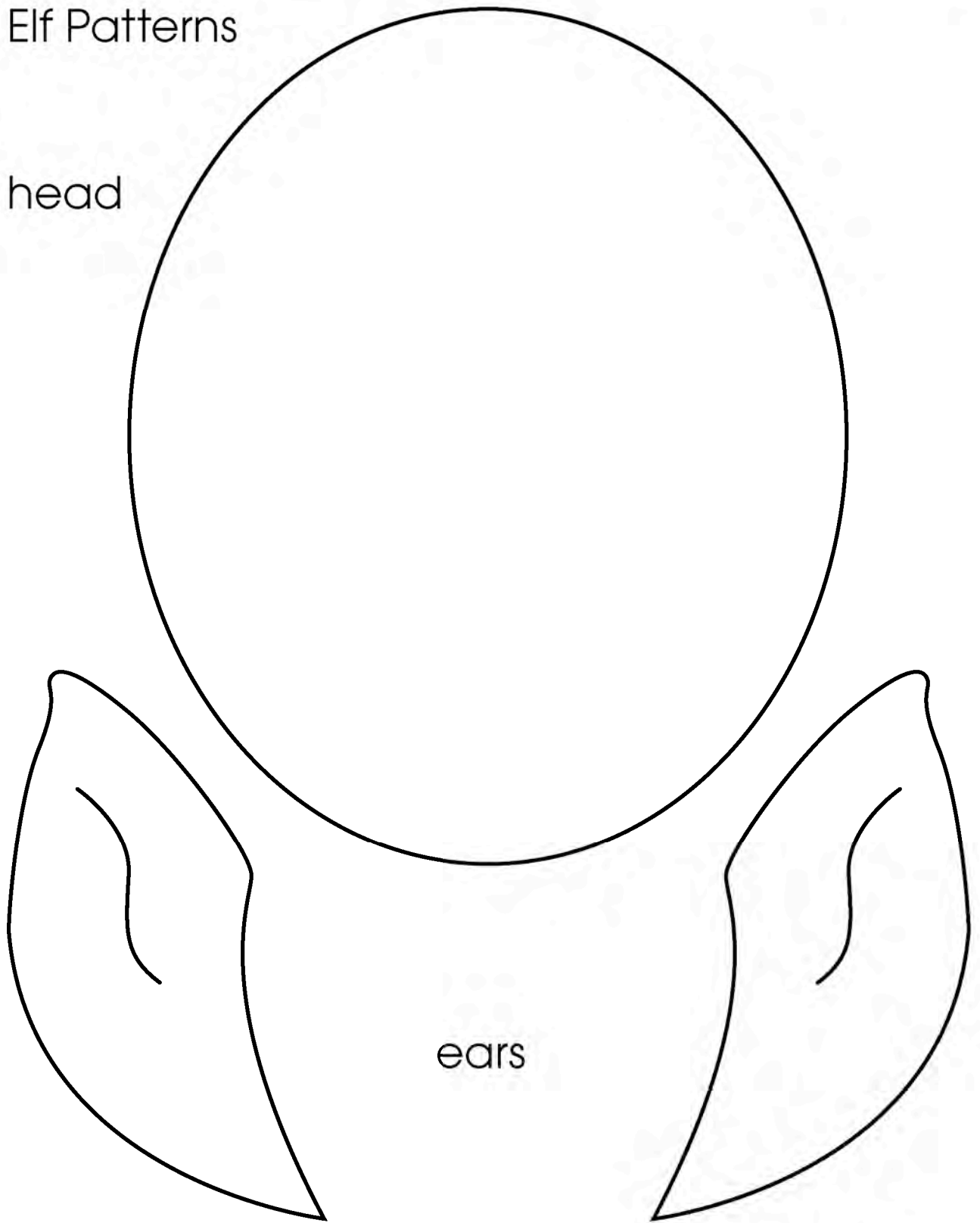

ears

Ee

A B C D E F G H I J K L M

Hat Patterns

top

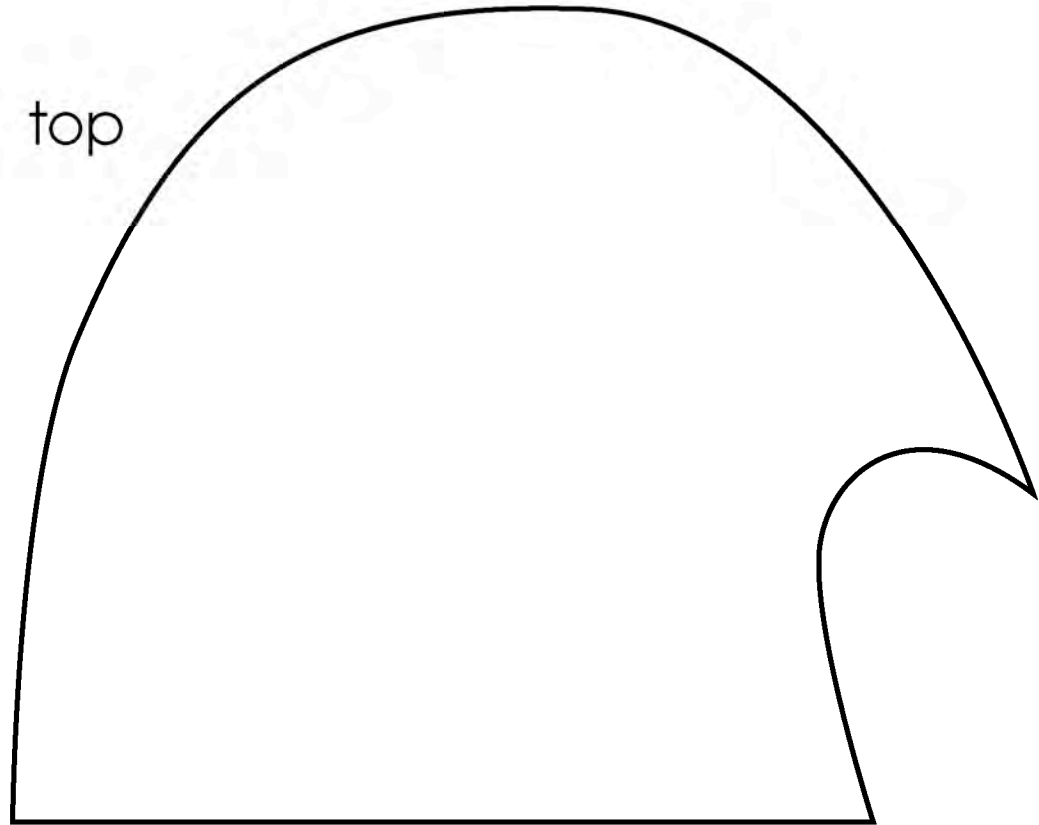

bottom

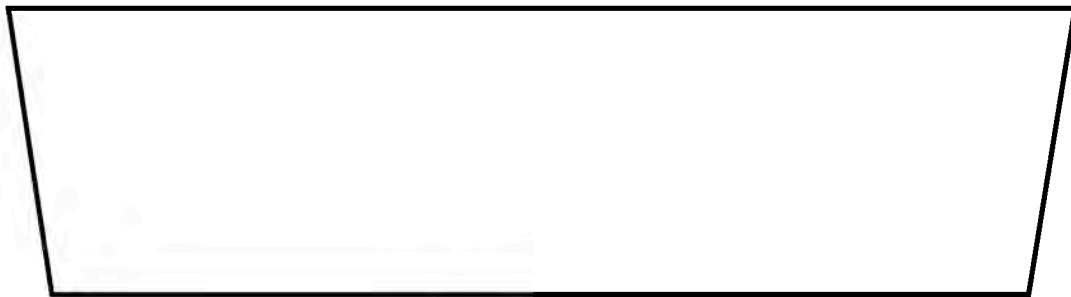

Elephant Pattern

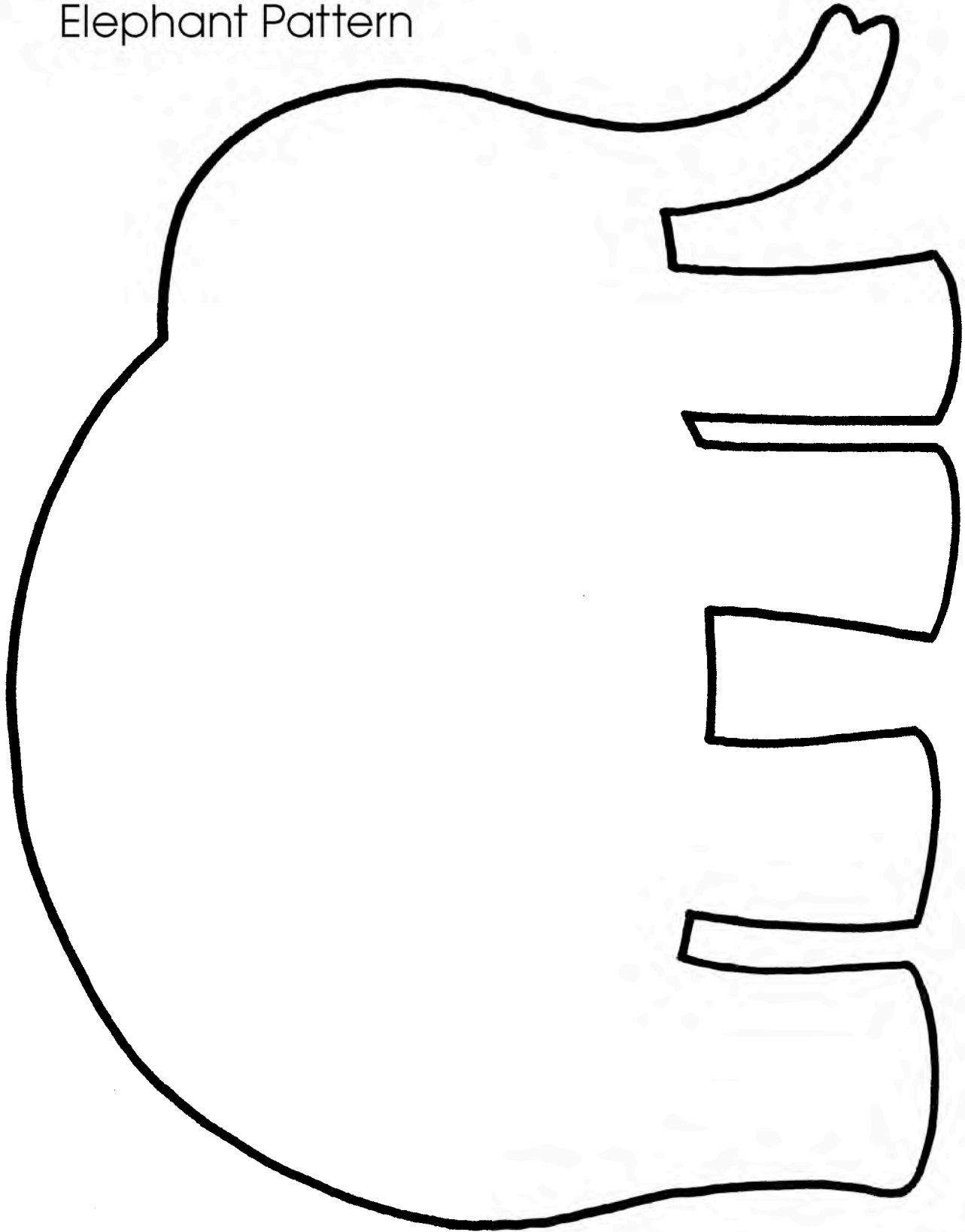

Ee

A B C D E F G H I J K L M

Letter Grid

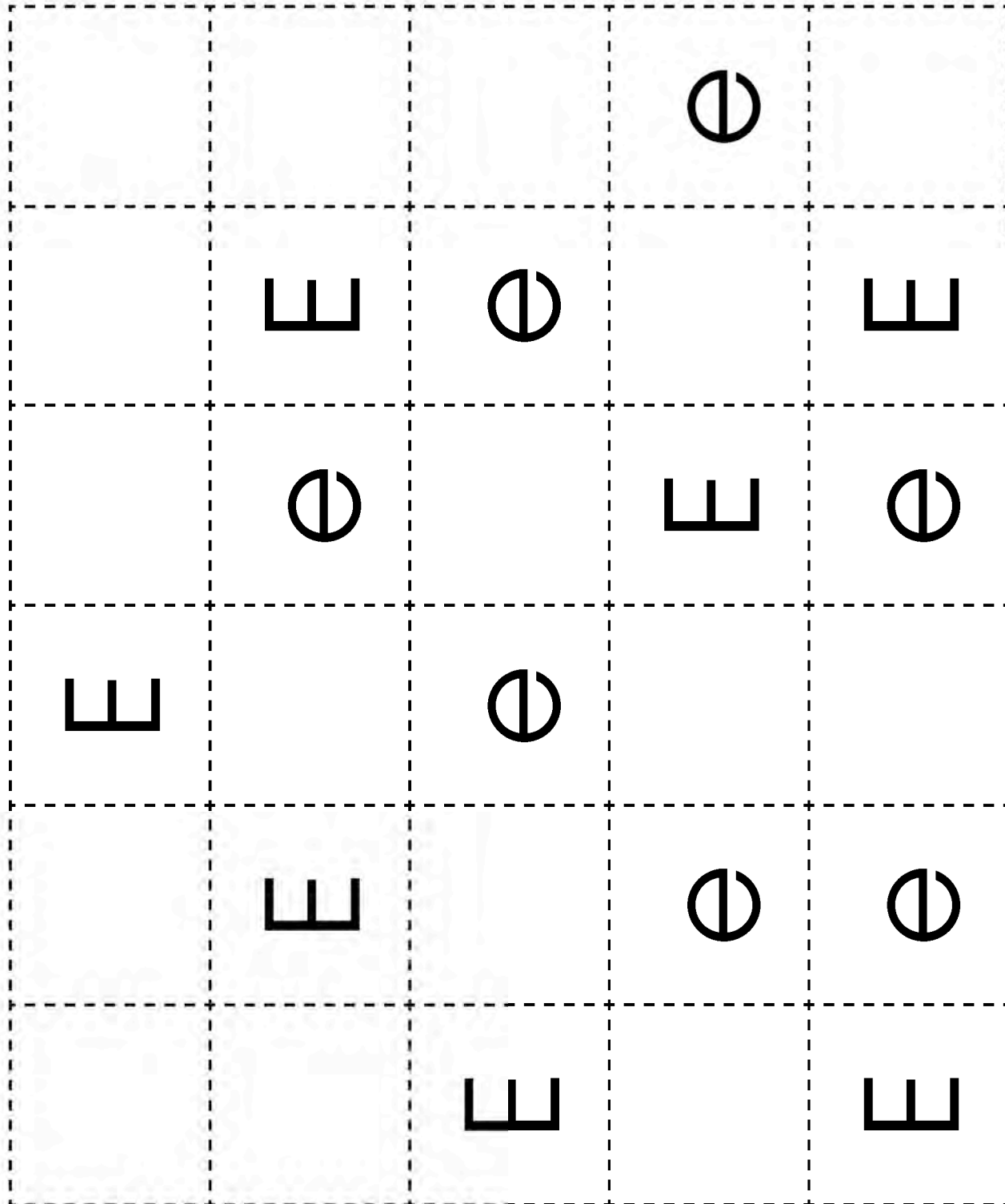

Emily Elephant Sees...

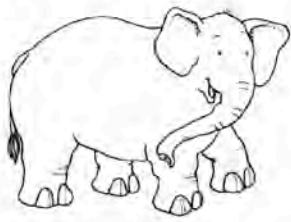

Name: _____

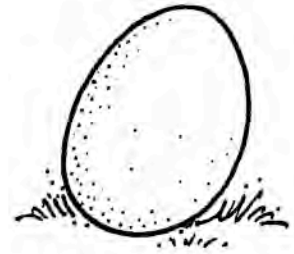

an **e**gg,

1

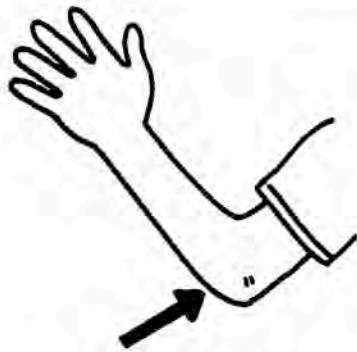

an **e**lbow,

2

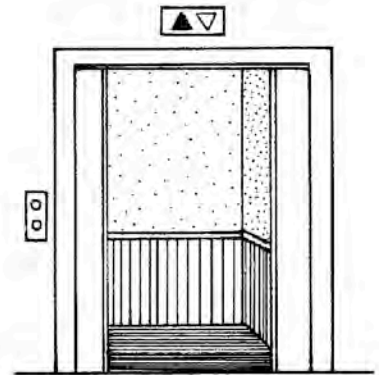

an **e**levator,

3



an **e**lf,

4



and the letter **Ee**!

5

Introducing *Ff*

Before beginning your study of the letter *Ff*, remove the picture cards that begin with this letter (pages 191 and 193). Cut apart and laminate the cards for durability. Then write an uppercase and lowercase *F* on the chalkboard, or display a large letter card. Show children each picture card. As you name the picture, emphasize its beginning sound. Then point to and name the letter *F* on the board. Have children repeat the word and the sound of *F* at the beginning of the word. After reviewing, keep the cards on display and use them throughout your letter study.

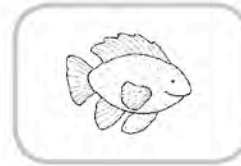

Math

F Is for Faces

Duplicate a supply of the shapes on page 45 onto colored construction paper. Then give children in a small group a paper plate and a supply of shapes to use in creating a variety of faces. Before beginning, ask children to tell what letter they hear at the beginning of the word *face*. Ask them to use a few different shapes to form a letter *F* on the tabletop. Next, have children use specific shapes to form faces on their plates. For example, you might say, “Use two hearts to make eyes on your face,” or “Use four triangles to make a mouth.” After directing children on what shapes to use, invite them to make faces of their own design, and then identify the shapes they’ve used for each feature.

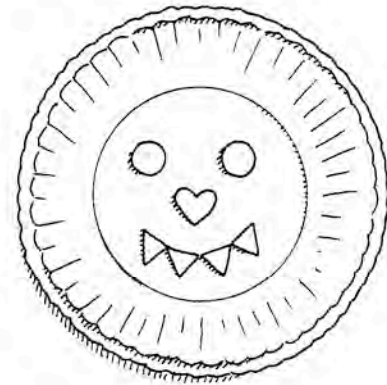

Craft

F Is for Firefly

This flashy firefly is a fun way to learn the sound of *F*! To make one, help children thoroughly coat the end of a jumbo craft stick with white glue and sprinkle a generous amount of gold glitter onto the glue. Then have them shake off the excess glitter and let the glue dry. Instruct them to glue a precut, black construction-paper heart to the craft stick, as shown. (You might use an enlarged heart pattern from page 45 as a template.) Finally, have children finish their firefly by gluing on some antennae shaped from a half-length of a colored pipe cleaner.

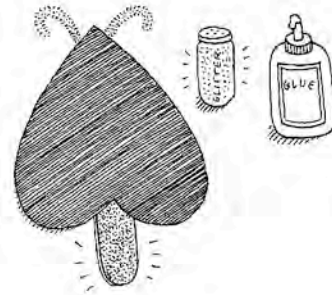

Game

F Is for Find the Feather

For this game, duplicate the letter *F* picture cards on page 46 onto tagboard, then laminate them, if desired. Display the pictures in rows in a pocket chart. Then hide a small craft feather behind one of the cards (or cut out a copy of the feather on page 47). To play, children take turns naming the picture card that they think might be hiding the feather. Repeat the name of the picture, emphasizing the beginning sound of *F* as children remove their card from the pocket chart to reveal what's behind it. Continue the game until a child finds the feather. Then hide it again for another round of play.

Movement

F Is for Funny Falls

Children will love this silly idea! Say aloud a list of words, including some words that begin with the sound of *F*. Each time children hear a word that begins with *F*, they dramatically fall to the floor and “freeze” into a silly pose. Then, on a signal, they hop up again to listen for the next word.

Some words that begin with *F*:

- fair family
- fast fizz
- fiddle fit
- fan furry

Snack

F Is for Forest Fare

This letter *F* snack may become a class favorite! In advance, tint a tub of cream cheese spread with green food coloring. Then give children four round and four rectangular whole-wheat crackers and a plastic knife or wide craft stick (to serve as a knife). First, have them use their rectangular crackers to make the shape of a letter *F*. Then invite children to spread cream cheese onto each of their round crackers. To make trees, have them put each round cracker at the top of a rectangular cracker. When children have four trees side by side on their napkin, they'll have a forest that tastes just great!

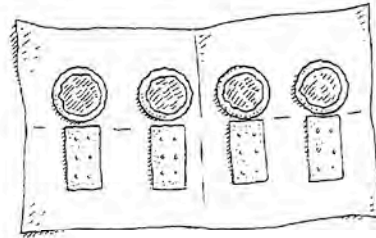

Literature

F Is for Fish Is Fish

After reading aloud *Fish Is Fish* (Knopf Books for Young Readers, 2005) by Leo Lionni, have children fish for the letter *F* with this game that also reinforces the letter sound. Cut several simple fish shapes from construction paper. (Or use die-cut fish.) Label each fish with a different letter, making sure only one shows the letter *F*. Lay the fish letter-side-down on a blue paper pond. Then gather a small group of children around the pond. Have children take turns naming a word that begins with the sound of *F*. Then have them pick a fish from the pond. If a child picks a fish that shows the letter *F*, that child wins the round. If the fish shows any other letter, children return it to the pond and play continues. Repeat the activity as many times as desired.

Letter Ff Mini-Book

Reinforce children's knowledge of the letter *F* and their letter-writing skills with this mini-book. First, duplicate a class supply of the mini-book patterns (page 47). Ask children to color the cover and pages, write their name on the cover, and trace the letters on page 5. Then have children cut apart the pages, stack them in order behind the cover, and staple the mini-book together in the upper left corner. Read the mini-book aloud as a class, emphasizing the beginning sound of *F* in the appropriate words. Then send the mini-books home for children to share with their family.



Shape Patterns

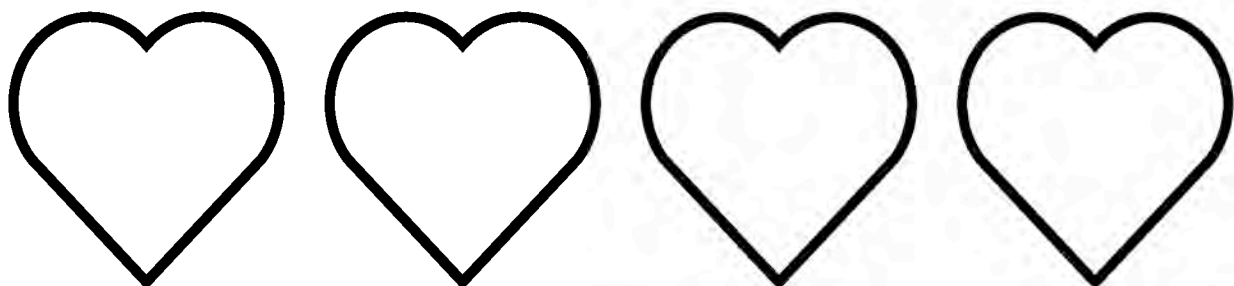
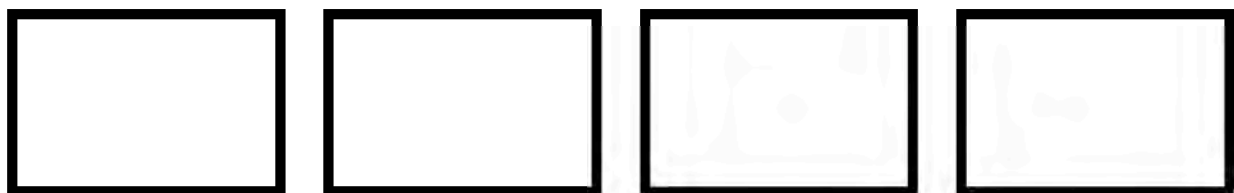
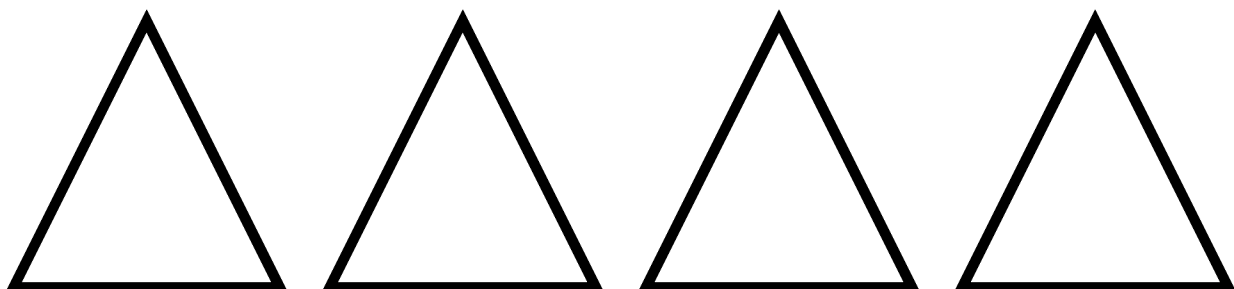
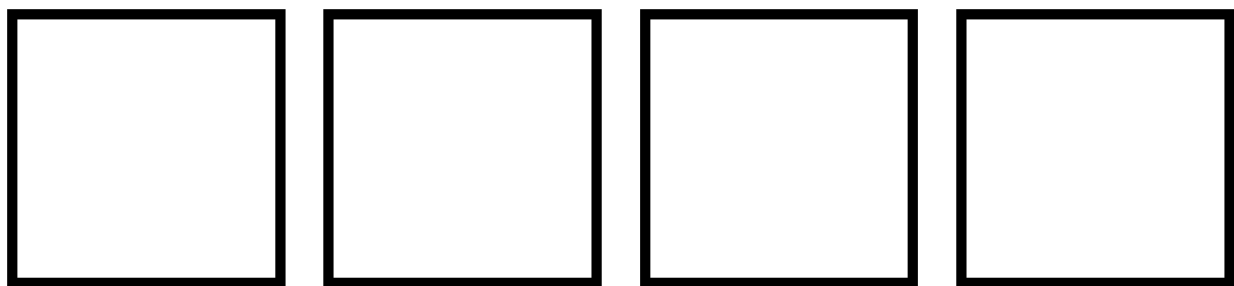
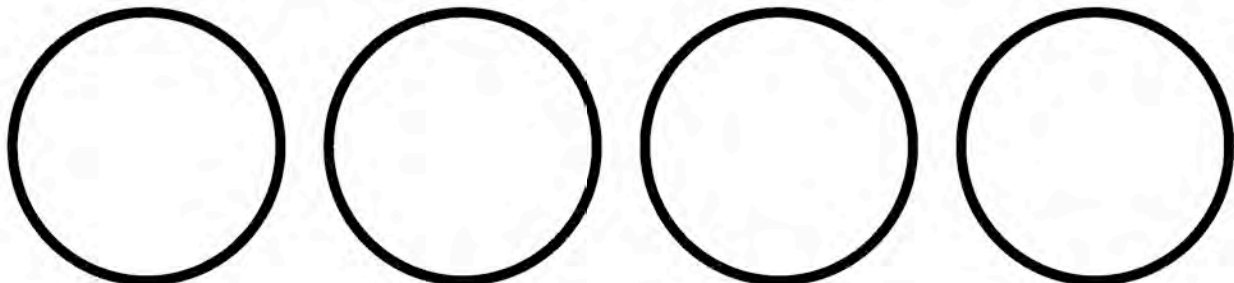

Ff

A B C D E F G H I J K L M

Letter F Picture Cards

4

5

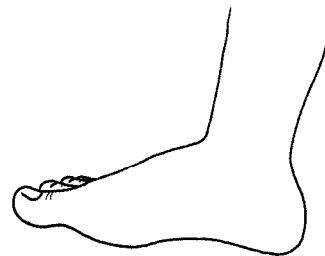
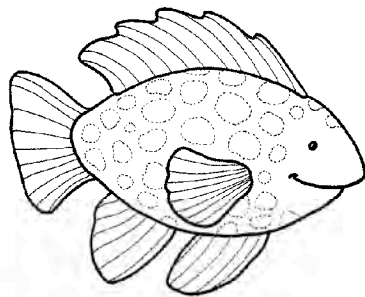
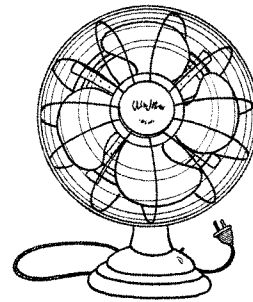
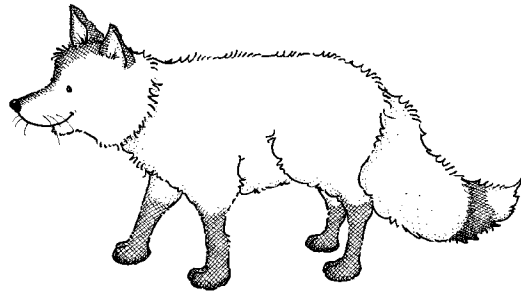

Fiona Fox Finds...

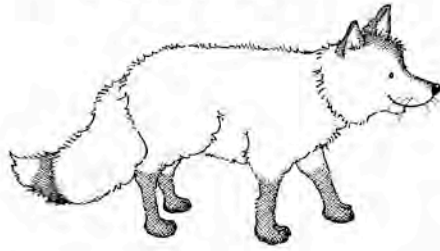

Name: _____

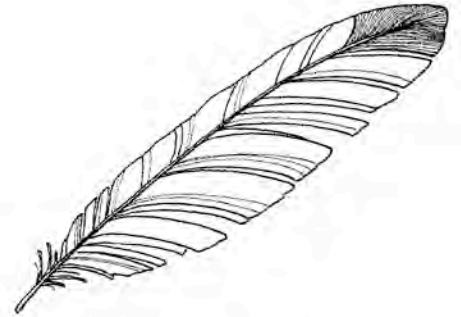

a **f**eather,

1

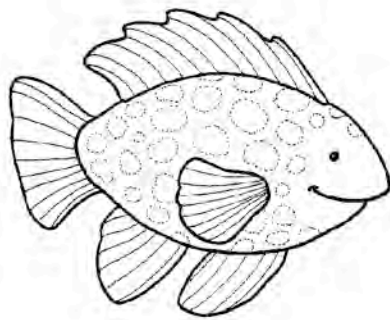

a **f**ish,

2

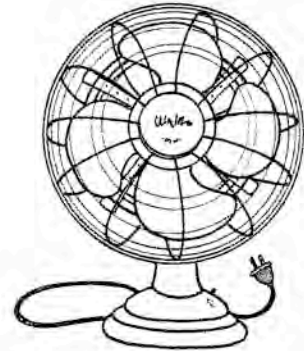

a **f**an,

3

5

a **f**ive,

4

Ff

and the letter **Ff**!

5

Introducing Gg

Before beginning your study of the letter *Gg*, remove the picture cards that begin with this letter (pages 195 and 197). Cut apart and laminate the cards for durability. Then write an uppercase and lowercase *G* on the chalkboard, or display a large letter card. Show children each picture card. As you name the picture, emphasize its beginning sound. Then point to and name the letter *G* on the board. Have children repeat the word and the sound of *G* at the beginning of the word. After reviewing, keep the cards on display and use them throughout your letter study.

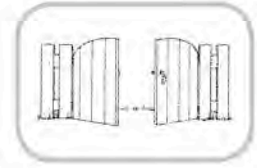
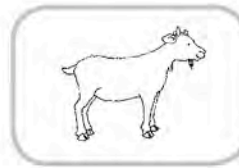

Math

G Is for Gumballs

Roll out the play dough for this math activity that focuses on comparing sets. Duplicate enough copies of the gumball machine pattern (page 51) for a small group. Cut out the patterns and laminate them. Give children some play dough and a gumball machine to use as a mat. Then ask them to roll their play dough into small balls—gumballs! Before beginning the math activity, have children arrange several of their

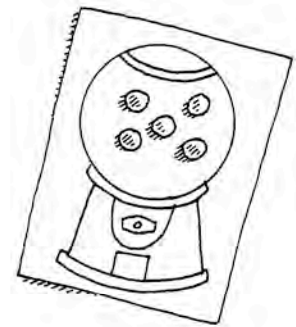
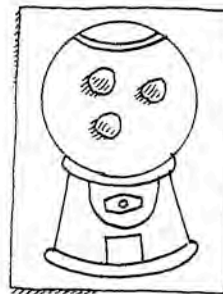

gumballs to form a letter *G*. Remind them that *gumballs* starts with the sound of *G*. Next, ask two children at a time to put specified numbers of gumballs on their mats. You might say, “Amy, put three gumballs on your gumball machine. Trevor, put six gumballs on yours.” Then ask the children to compare the quantity of gumballs on their mats. Who has more? Continue with other pairs, emphasizing the concepts of *more*, *fewer*, and *equal* as you go.

Craft

G Is for Golfball

Show children a golfball and point out that the word begins with the sound of the letter G. Then explain that they are going to use a golfball as a painting tool! For each child, place a sheet of white construction paper in the bottom of a shallow box. Dip a golfball into tempera paint in the child's choice of colors. Then drop the ball into the box and have the child tilt the box back and forth to make the golfball roll across the paper, creating a unique design. Repeat the process using other paint colors, if desired. When the golfball paintings are dry, have children trace a large letter G on top of the painting and cut around the outline. (You can use a large, tagboard die-cut letter.) Display these letter-perfect works of art with the title, "Golly—Golfball Painting!"

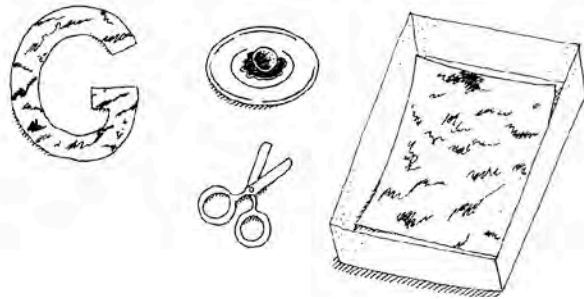

Game

G Is for Gifts

One of the gifts in this game holds a letter G—but which one is it? To prepare this small-group game, gather several small gift boxes. Put a colorful bow atop each one. Then hide a magnetic or foam letter G inside one box. Put the boxes on your floor and gather a small group of children. Have them take turns opening one box at a time until someone finds the hidden G. To play again, secretly hide the G in a different box for the next round.

Movement

G Is for Geese

Make a set of large letter cards for this game, each labeled with an uppercase or lowercase G. Explain to children that they will pretend to be geese, flying south and north, depending on what letters they see. Designate one end of an open area as the "south" end and tell children to fly here when they see an uppercase G. Designate the other end as "north" and tell children to fly there when they see a lowercase g. Have children stand in the middle of the area to begin the activity. Then hold up one letter card at a time for all the "geese" to see and decide whether they need to fly "south" or "north" (or stay in place, depending on where they are and the letter on the card).

Snack

G Is for Garden

Invite children to make a garden of goodies with this snack idea. In advance, add food coloring to a mild-flavored vegetable dip to tint it green. Put the dip into a squeeze bottle. (Thin it with a little milk, if necessary, so that it flows smoothly from the bottle.) Then give children a few round slices of yellow squash on a paper plate. Have them line up their squash slices in a row, explaining that the rounds represent flower blossoms.

Then help children squeeze dip from the bottle to make a green stem and leaves for each of their flowers. After completing their gardens, tell children that *garden* begins with a G. Finally, invite children to pluck their flowers, slip them into the dip, and munch away!

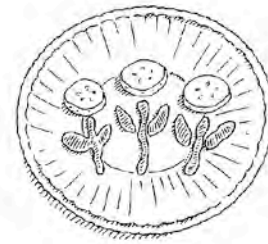

Literature

G Is for Good Night, Gorilla

Follow up a reading of *Good Night, Gorilla* (Putnam, 2000) by Peggy Rathmann, with this sound-recognition activity. Say aloud a list of words, including some that begin with the sound of G and some that do not. Tell children to pretend to fall asleep each time they hear a word that begins with G. Then, when they hear a word that begins with any other letter, they wake up.

Some words that begin with G:

gold	gill
gift	goof
gum	garden
good	goose
golf	gap

Letter Gg Mini-Book

Reinforce children's knowledge of the letter G and their letter-writing skills with this mini-book. First, duplicate a class supply of the mini-book patterns (page 52). Ask children to color the cover and pages, write their name on the cover, and trace the letters on page 5. Then have children cut apart the pages, stack them in order behind the cover, and staple the mini-book together in the upper left corner. Read the mini-book aloud as a class, emphasizing the beginning sound of G in the appropriate words. Then send the mini-books home for children to share with their family.

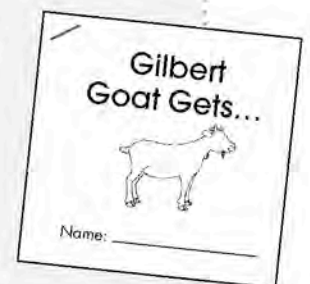

Gumball Machine Pattern

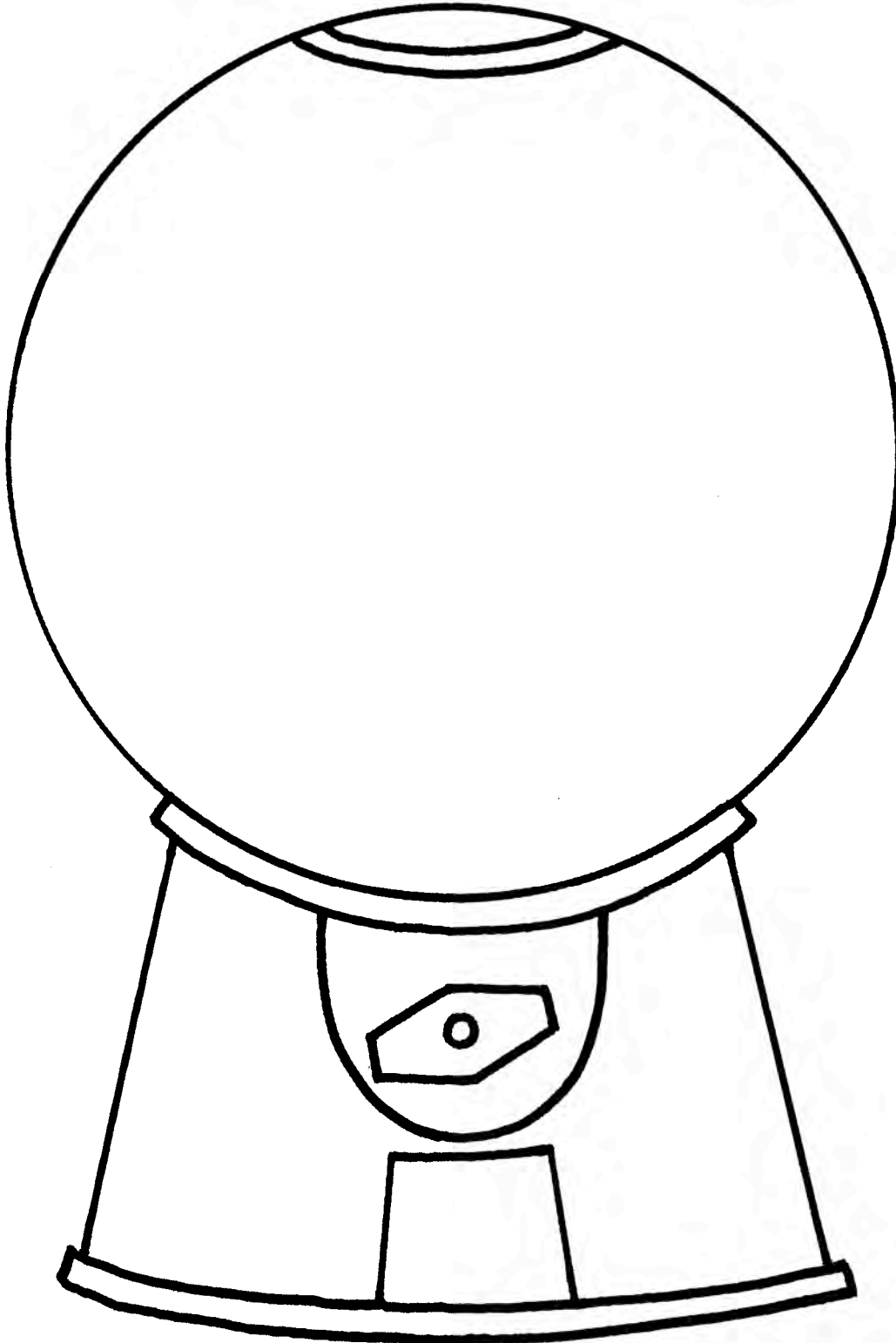

Gilbert Goat Gets...

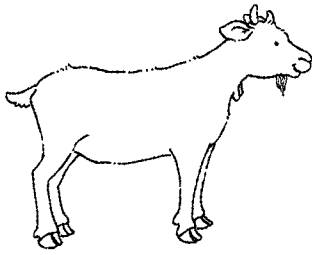

Name: _____



a **g**uitar,

1



a **g**ame,

2



a **g**ift,

3

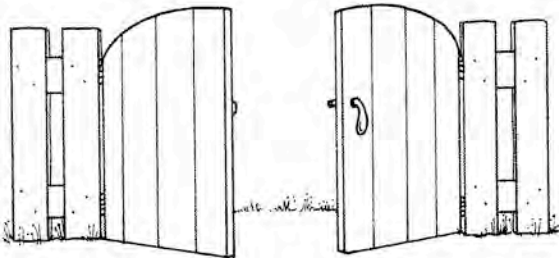

a **g**ate,

4



and the letter **Gg!**

5

Introducing *Hh*

Before beginning your study of the letter *Hh*, remove the picture cards that begin with this letter (pages 197 and 199). Cut apart and laminate the cards for durability. Then write an uppercase and lowercase *H* on the chalkboard, or display a large letter card. Show children each picture card. As you name the picture, emphasize its beginning sound. Then point to and name the letter *H* on the board. Have children repeat the word and the sound of *H* at the beginning of the word. After reviewing, keep the cards on display and use them throughout your letter study.



Math

H Is for Hands

How many is a handful? That's what children will find out with this small-group estimation activity. First, show children a plastic counting bear (or another small manipulative). Have them estimate how many of the bears they could pick up with one hand and then record that number on a sticky note. Then invite children to take turns picking up a handful of the bears from a container and counting how many they can hold. (Use this opportunity to point out that *hand* begins with the letter *H*.) Have them compare the actual results with their estimates and discuss whose guesses were too high, too low, or just right.



Craft

H Is for Helicopter

Children will fly to your art area to make these helicopters! To prepare, duplicate the helicopter patterns (page 56) onto various colors of construction paper. Invite children to choose a color and cut out the shapes. Then help them glue their cutouts together on light blue construction paper, as shown, to make a helicopter. As children work, point out that *helicopter* starts with the sound of *H*. After assembling their aircraft, have children draw on details and then glue on two jumbo craft sticks to represent the helicopter blades. Finally, invite them to glue a few stretched cotton-ball clouds on the sky around their helicopter. Display these cute copters for everyone to admire!

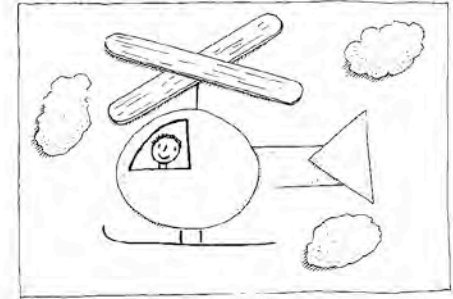

Game

H Is for Hat

For this pass-the-hat game, first make a supply of letter cards. Label most of the cards with an uppercase or lowercase *H*, and a few with other letters. Fold the cards in half and place them in a hat. Then seat children in a circle and pass the hat. As children receive the hat, have them pull out a card and identify the letter on it. If their card shows an *H* or *h*, children put it back in the hat and continue to pass the hat. If the card shows a different letter, they are “out” for the rest of the game and must let the hat pass by when it circles back around. Each time the hat is passed around the circle, remove one or two of the *H* cards. Then continue play until only one child is left and declared the “Happy Hero of the *H* Game!”

Movement

H Is for Hop to the Hoop

Duplicate the picture cards on page 57 and gather some plastic hoops for this active small-group game. Spread the hoops out in an open area, then tape a picture card next to each hoop. To play, give a clue describing one of the pictures. Call on a child to guess which picture you described by hopping to it and then standing in the corresponding hoop. Verify whether the child identified the correct picture, emphasizing the beginning sound of *H* as you name the picture.

Snack **H Is for Hearts With Honey**

Hungry for a simple snack to reinforce the letter *H*? Here it is! For each child, toast a slice of whole-wheat bread. Then help children use a heart-shaped cookie cutter to cut a heart from their toast. Invite them to use a squeeze bottle of honey to “write” a letter *H* on top of the heart. Children are sure to enjoy this hearty, healthy treat!

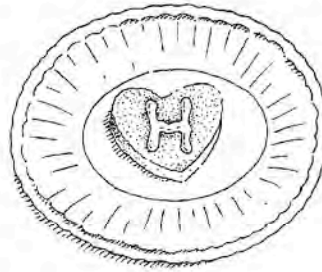

Literature **H Is for The Hiccupotamus**

Children will love *The Hiccupotamus* (Marshall Cavendish, 2009) by Aaron Zenz—a very silly tale of a hippopotamus with the hiccups! After reading the book aloud, encourage children to demonstrate their best fake hiccups with this phonemic awareness activity. Say a list of words, including several that begin with the letter *H*, and a few that begin with other letters. Have children hiccup each time they hear a word beginning with *H*.

- Some words that begin with *H*:**
- hello
 - hair
 - hammer
 - handsome
 - hill
 - hug
 - hockey
 - hook

Letter *Hh* Mini-Book

Reinforce children’s knowledge of the letter *H* and their letter-writing skills with this mini-book. First, duplicate a class supply of the mini-book patterns (page 58). Ask children to color the cover and pages, write their name on the cover, and trace the letters on page 5. Then have children cut apart the pages, stack them in order behind the cover, and staple the mini-book together in the upper left corner. Read the mini-book aloud as a class, emphasizing the beginning sound of *H* in the appropriate words. Then send the mini-books home for children to share with their family.

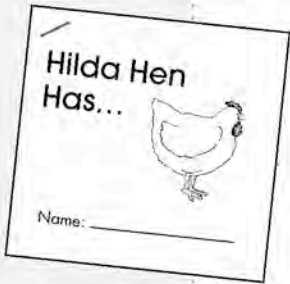

Hh

A B C D E F G H I J K L M

Helicopter Patterns

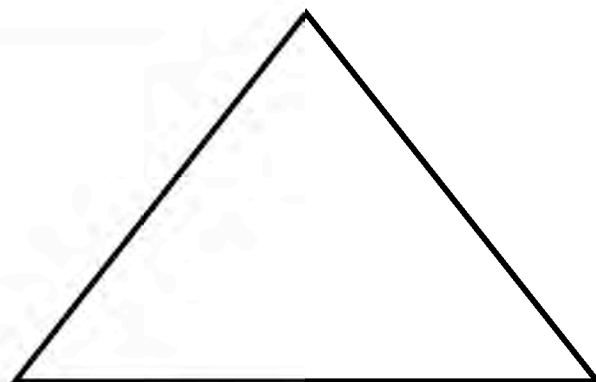
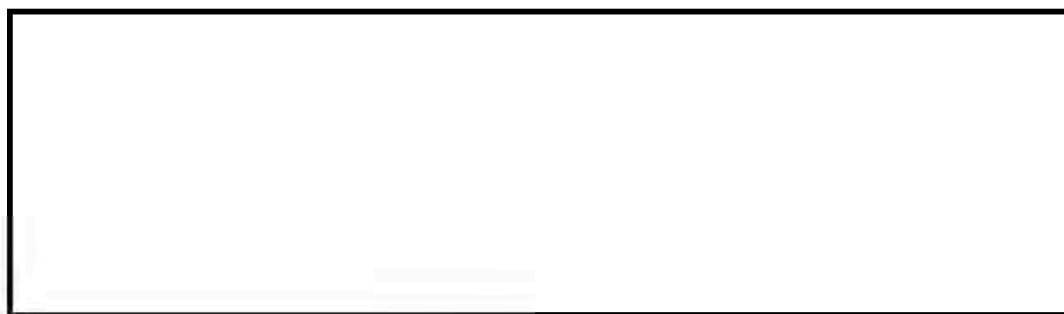
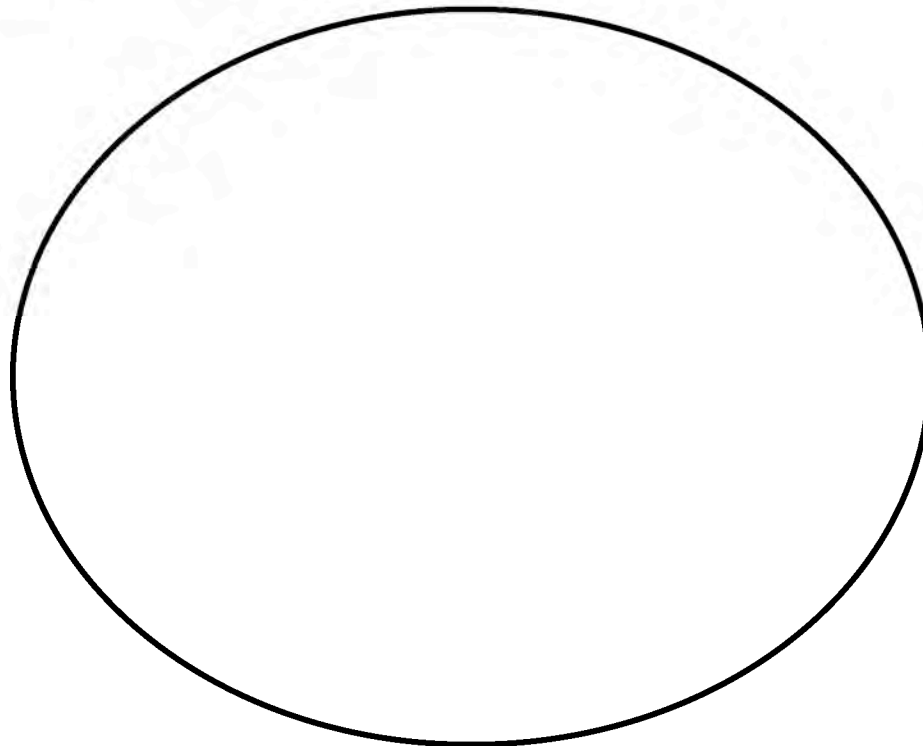

Letter H Picture Cards

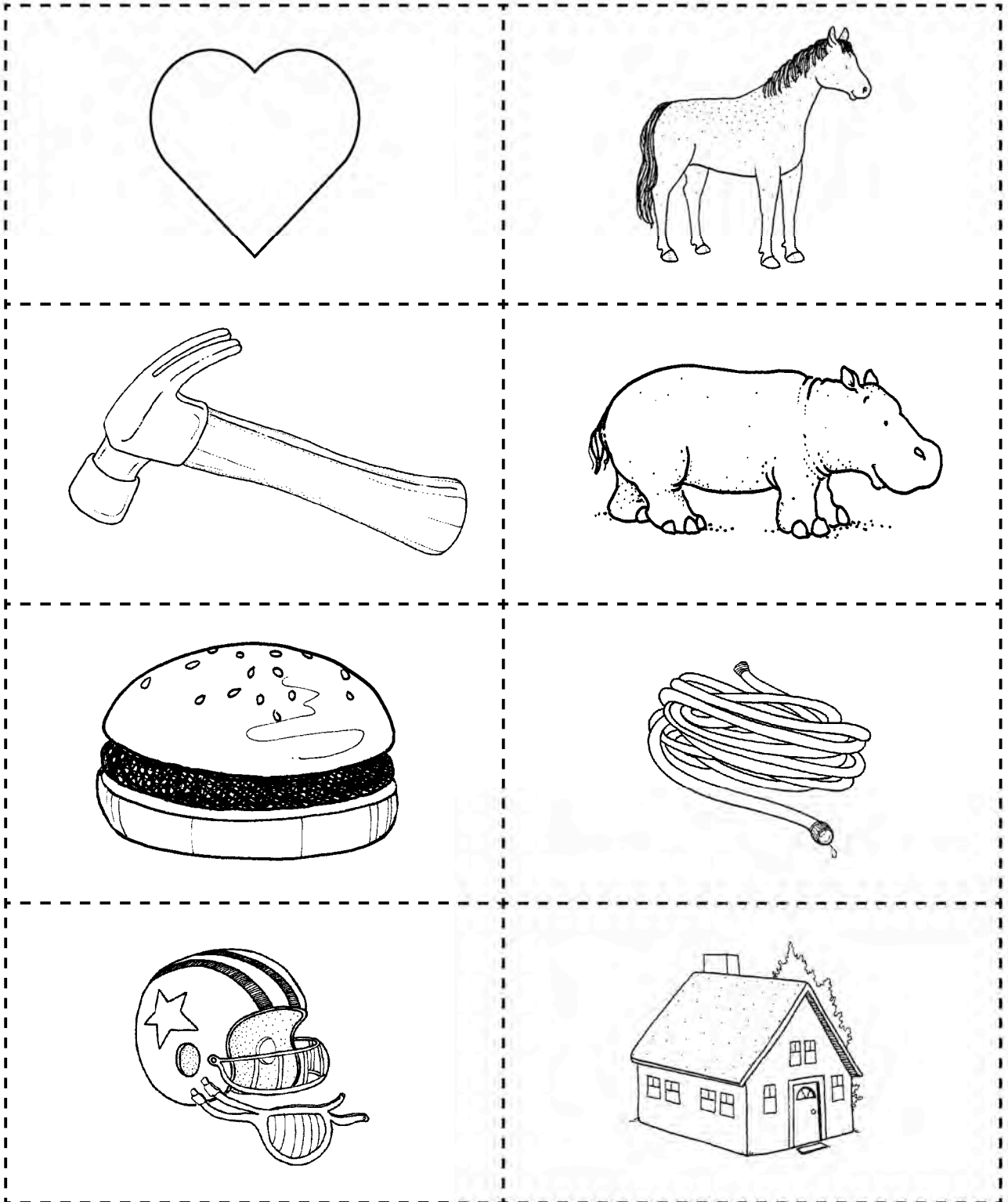

Hilda Hen
Has...

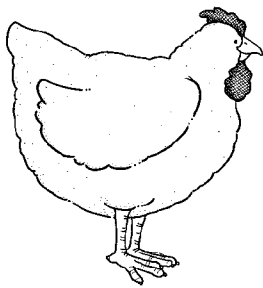

Name: _____

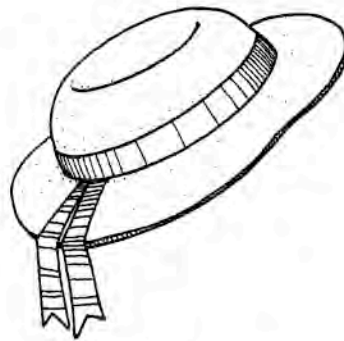

a **h**at,

1

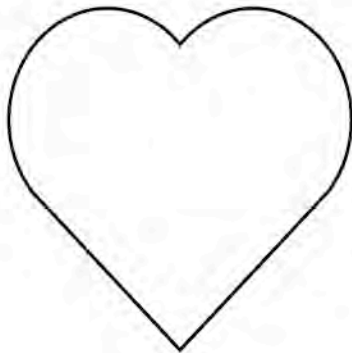

a **h**ear**t**,

2

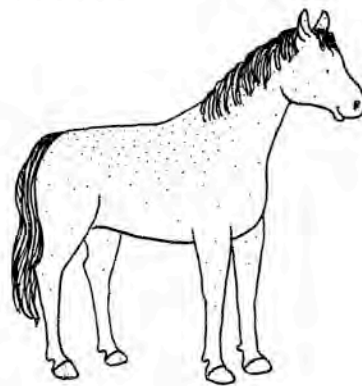

a **h**orse,

3



a **h**elicopter,

4



and the letter **Hh**!

5

Introducing *Ii*

Before beginning your study of the letter *Ii*, remove the picture cards that begin with this letter (pages 201 and 203). Cut apart and laminate the cards for durability. Then write an uppercase and lowercase *I* on the chalkboard, or display a large letter card. Show children each picture card. As you name the picture, emphasize its beginning sound. Then point to and name the letter *I* on the board. Have children repeat the word and the sound of *I* at the beginning of the word. After reviewing, keep the cards on display and use them throughout your letter study.

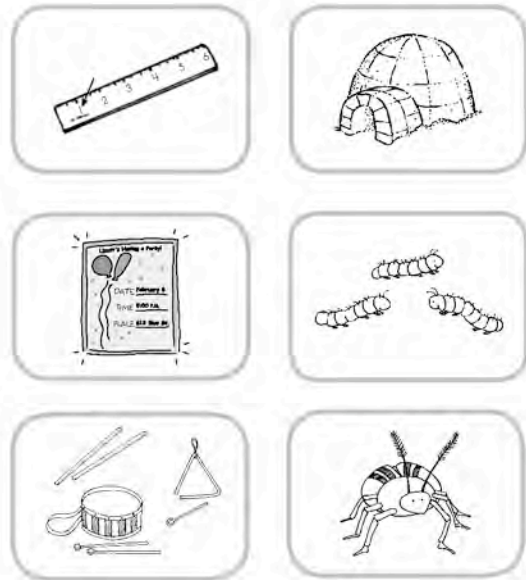

Math

I Is for Igloo

For this estimation activity, duplicate a class supply of the igloo record sheet on page 62. Use a paper cutter to make a large supply of 1-inch squares of white construction paper. Then give children a record sheet and a pile of white paper “ice blocks.” Point out that *igloo* begins with the sound of the letter *I*. Then ask children to estimate how many of the ice blocks will be needed to cover the outline of the igloo. Have them record their estimate on the left line at the bottom of the page. Then instruct children to cover the igloo with paper squares, count the squares, and record their findings on the right line at the bottom of the page. Discuss whose estimates were too high, too low, and just right.

Ii

Name: _____ Date: _____

Igloo Record Sheet

I guessed: _____ ice blocks I counted: _____ ice blocks

The Big Book of Alphabet Activities © 2011 by Ada Goren, Scholastic Teaching Resources, page 62

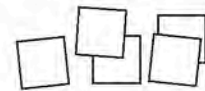

Craft

I Is for Insect

Invite children to exhibit their individuality with this project. Tell children that *insect* begins with the sound of *I*. After discussing the distinctive features of an insect (three body parts, six legs, two antennae), give each child a portion of Crayola® Model Magic™ modeling compound. Have children use the compound to form three body parts for their insect. Then set out a variety of art materials for them to use to create legs, antennae—and possibly wings—for their insects. (Supply pipe cleaners, coffee stirring sticks, drinking straws, scraps of laminating film, craft wood shapes, and any other appropriate materials you have on hand.) You're bound to see some inventive insects!

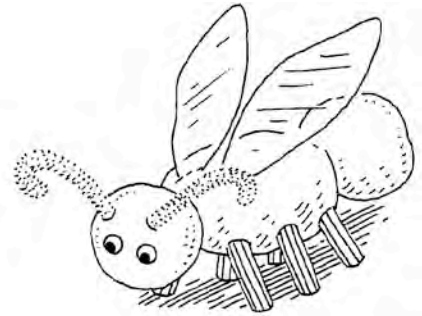

Game

I Is for Instruments

Bring out the drums, triangles, and sticks for this letter-recognition game! After gathering a class supply of rhythm instruments, make some letter cards, labeling most of them with an uppercase or lowercase *I*, and writing different letters on the remaining cards. Pass out the instruments and remind children that *instruments* begins with the short sound of *I*. Then ask children to watch as you show the letter cards one at a time. Explain that each time you hold up the letter *I* (uppercase or lowercase), they should play their instrument. If the letter is not an *I*, they should keep their instrument silent.

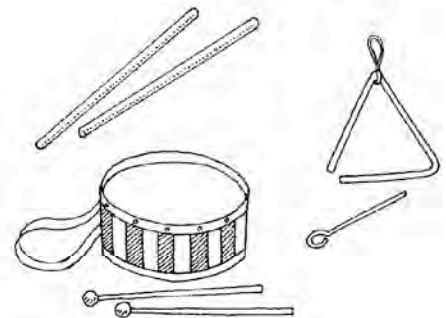

Movement

I Is for Imitations

Emphasize the short sound of letter *I* with some imitations. First, perform a movement, such as twisting back and forth at the waist, and ask children to copy—or imitate—you. Then ask another child to be the leader and have everyone imitate his or her action. Continue until every child has had a chance to be the leader.

Snack **I Is for Initial**

There are only three ingredients for this interesting letter *I* snack—a can of refrigerated bread dough, butter, and marinara sauce. Have children roll out a portion of bread dough on a lightly floured surface to create a dough rope. Then help them form the rope to create the first initial of their name. (If using several sections of a dough rope, be sure to pinch together firmly any spots where the lines join.) Have children brush their initial with a bit of softened or melted butter. Then bake the dough letters at 350° F for about 15 minutes. Serve these edible initials with a side of marinara sauce for dipping. As they snack away, remind children that *initial* begins with the letter *I*.

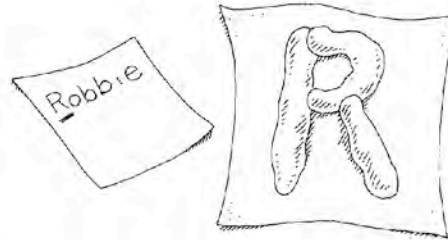

Literature **I Is for Itchy, Itchy Chicken Pox**

Just hearing *Itchy, Itchy Chicken Pox* (Cartwheel, 1992) by Grace Maccarone might make children feel itchy! Give them a chance to scratch with this phonemic awareness activity. First, ask children to listen as you say a list of words in which most begin with the letter *I*, and the rest begin with other letters. Each time they hear a word that begins with the short *I* sound, have children pretend that parts of their body—such as their legs, tummy, arms, or back—are itchy and must be scratched!

- Some words that begin with I:**
- infant
 - impossible
 - igloo
 - inside
 - important
 - icky
 - ink
 - instant

Letter Ii Mini-Book

Reinforce children's knowledge of the letter *I* and their letter-writing skills with this mini-book. First, duplicate a class supply of the mini-book patterns (page 63). Ask children to color the cover and pages, write their name on the cover, and trace the letters on page 5. Then have children cut apart the pages, stack them in order behind the cover, and staple the mini-book together in the upper left corner. Read the mini-book aloud as a class, emphasizing the beginning sound of *I* in the appropriate words. Then send the mini-books home for children to share with their family.

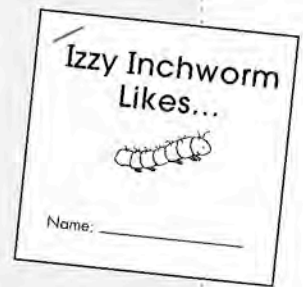

Ii

Name: _____ Date: _____

Igloo Record Sheet

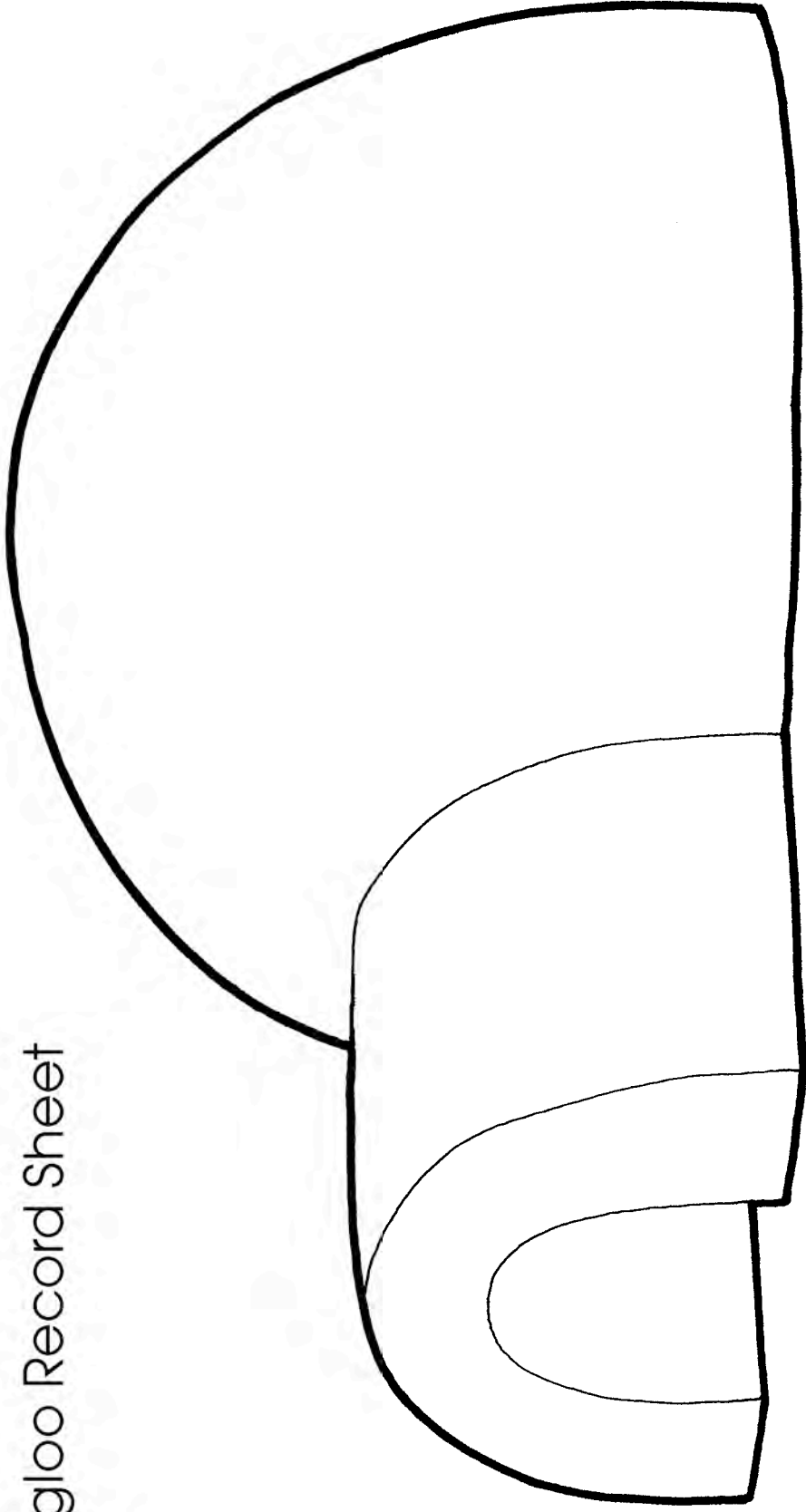

I guessed: _____ ice blocks I counted: _____ ice blocks

Izzy Inchworm Likes...

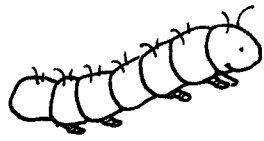

Name: _____

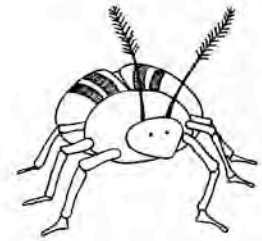

an **i**nsect,

1

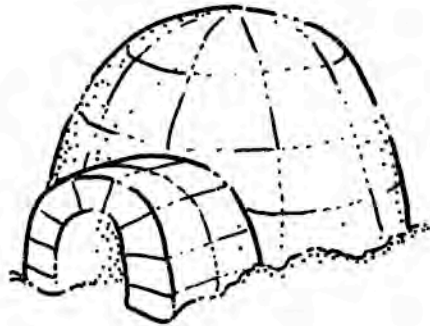

an **i**gloo,

2



an **i**nvitation,

3

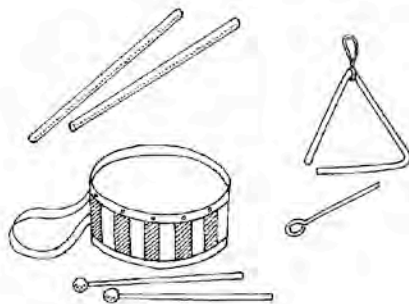

instruments,

4



and the letter **Ii**!

5

Jj



Introducing Jj

Before beginning your study of the letter *Jj*, remove the picture cards that begin with this letter (pages 203 and 205). Cut apart and laminate the cards for durability. Then write an uppercase and lowercase *J* on the chalkboard, or display a large letter card. Show children each picture card. As you name the picture, emphasize its beginning sound. Then point to and name the letter *J* on the board. Have children repeat the word and the sound of *J* at the beginning of the word. After reviewing, keep the cards on display and use them throughout your letter study.



Math

JIs for Jellybeans

Bring in a bag of jellybeans for some sweet sorting practice! Duplicate a class supply of the jellybean sorting mat on page 67. Ask children to color each jellybean on their mat to match one of the colors of the jellybeans you've brought to school. (Check that they color each jellybean a different color.) As they work, point out that *jellybean* begins with the sound of *J*. Then give children a small cupful of jellybeans to sort by color onto their mat. When finished, talk about the results of their sorting: Which color did children have the most of? The fewest? Finish up by asking children to turn over their mats and use their jellybeans to form a letter *J* on the back. Then invite them to eat up these yummy manipulatives!

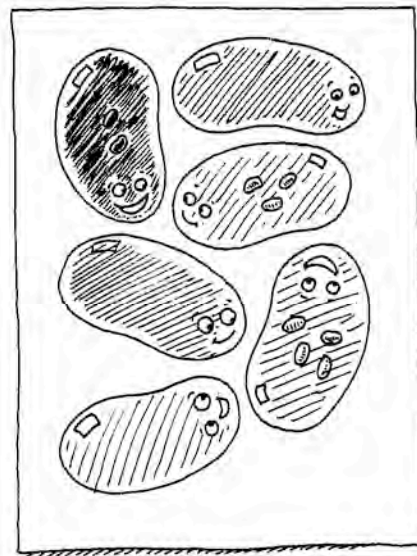

Craft

JIs for Jazzy Jars

These jeweled jars make lovely gifts when filled with votive candles or small candies. To prepare, dilute white glue with water to thin it out enough so it can be spread with a paintbrush. Set the glue out with a supply of colorful tissue paper that has been torn into small squares. Then have children brush the diluted white glue onto a baby food jar. Have them stick on tissue-paper squares in the colors of their choice, overlapping the squares to cover the entire outside surface of the jar. Help them paint a final coating of the glue over the tissue paper. Once the glue dries, invite children to glue on a few sparkly plastic gems to complete the project. As they work, point out the beginning sound of *J* in the words *jar* and *jewel*.



Game

JIs for Join In

Anyone who knows a word that begins with the sound of *J* can join this *J* train! To begin, ask a child to name a word that begins with *J*. Have the child stand in front of the group and call on a classmate to name a word that begins with the *J* sound. Then the two children join hands and begin to chug around the room. The second child calls on another classmate to name a *J* word and join the train. Continue growing and moving the train in this way, with each new child who joins the train calling on the next child to give a word, until everyone has given a word (with some help from you, if needed) and joined in.

Movement

JIs for Jog, Jump, and Juggle

For lots of action and lots of practice with the letter *J*, have a *J*-Relay! Plot a course in an open area where two teams of children can jog to some lines taped on the floor, jump over three or four lines in succession, and then grab two scarves to “juggle.” Divide the class into two teams and have the members of each team line up one behind another. Give a starting signal and have the first child on each team jog, jump, and juggle his or her way through the course. After completing the course, the child then drops the scarves and jogs back to tag the next team member. The first team to complete the *J*-Relay is the winner!

Jj



Snack

JIs for Jam Jamboree

What better way to celebrate the letter *j* than with a Jam Jamboree? Bring in four different kinds of sugar-free jam for children to try, such as strawberry, blackberry, grape, and raspberry. Toast a class supply of bread slices. Then help children cut their bread into four squares. Before trying the jams, ask them to arrange their bread squares on the plate in the shape of a letter *J*. Remind children that *jam* starts with a *J*. Then have children use plastic knives or craft sticks to spread a bit of each type of jam on their bread pieces. Vote on the class favorite.



Literature

JIs for Jump, Frog, Jump!

Get children jumping like the frog in Robert Kalan's *Jump, Frog, Jump!* (Greenwillow Books, 1989). Of course, there's a twist to this follow-up activity—children should only jump when they hear you say a word beginning with the sound of *J*. Say aloud a list of words in which most begin with *J*, and a few begin with other letters. Ready? Jump, children, jump!

Some words that begin with *J*:

job
junk
jingle
janitor
jeep
joke
jacket
joy

Letter *Jj* Mini-Book

Reinforce children's knowledge of the letter *J* and their letter-writing skills with this mini-book. First, duplicate a class supply of the mini-book patterns (page 68). Ask children to color the cover and pages, write their name on the cover, and trace the letters on page 5. Then have children cut apart the pages, stack them in order behind the cover, and staple the mini-book together in the upper left corner. Read the mini-book aloud as a class, emphasizing the beginning sound of *J* in the appropriate words. Then send the mini-books home for children to share with their family.

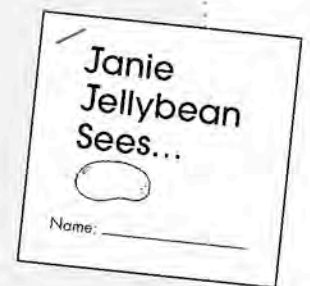

Jellybean Sorting Mat

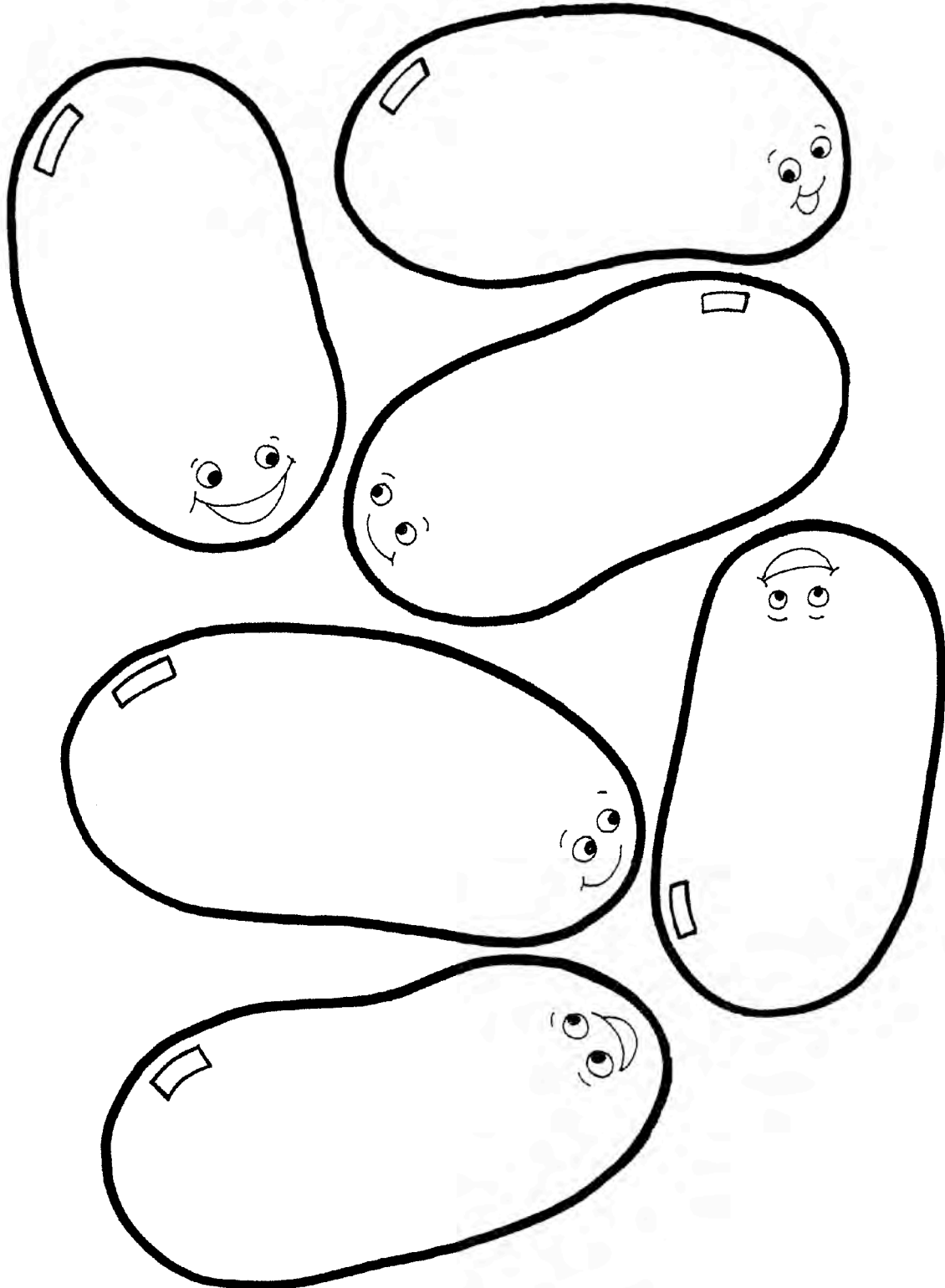

Janie Jellybean Sees...



Name: _____



a **j**et,

1



a **j**eep,

2



a **j**acket,

3



a **j**ack-o'-lantern,

4



and the letter **Jj**!

5

Introducing *Kk*

Before beginning your study of the letter *Kk*, remove the picture cards that begin with this letter (pages 207 and 209). Cut apart and laminate the cards for durability. Then write an uppercase and lowercase *K* on the chalkboard, or display a large letter card. Show children each picture card. As you name the picture, emphasize its beginning sound. Then point to and name the letter *K* on the board. Have children repeat the word and the sound of *K* at the beginning of the word. After reviewing, keep the cards on display and use them throughout your letter study.



Math

K Is for Kids

What's the best thing to use when practicing sorting? Why, the kids in your classroom, of course! Choose several different ways to sort children. You might start by sorting them by whether they are girls or boys. Then help children sort themselves by other attributes, such as hair color or eye color. Also, you might have them group themselves according to specific clothing characteristics (such as having long or short sleeves, or wearing jackets with or without a zipper). You can even sort kids into groups by whether their name starts with *K* or not. The possibilities are almost endless!

Craft

K Is for Keys

The keys to this project are just that—an assortment of keys! Use rolled tape to secure several different keys to a tabletop. Tape white copy paper over the keys. Then give children some crayons with the labels removed. Have them rub the side of a crayon over the paper, pressing down to make the impression of the keys underneath appear on their paper. Invite children to use several different colors as they work. Once they've colored over most of the paper, remove the paper from the table. Then help children trace a large tagboard *K* on top of their key rubbing. Have them cut out the letter and glue it to a sheet of construction paper in a coordinating color to complete the project.



Game

K Is for Kindergarten

Children practice recognizing words that begin with the sound of *K* with this game. Duplicate the picture cards (page 72) onto tagboard. Color the pictures as desired before cutting them apart. Then seat a small group of children in a circle. Tell them that they will play a game in which they pretend to pack for a day at kindergarten, but they'll be taking some unusual items—all of which begin with the letter *K*! Start the game by saying, "I'm going to kindergarten and I'm taking a..." Hold up one of the picture cards, have children identify the *K* word that describes the picture, and then use that word to complete the sentence. Lay the card down on the floor for the group to see. Next, give a child a picture card. Have the child repeat your sentence, then continue it by saying "...and a..." using the name of his or her picture card to add to the list of items being packed. Keep going, giving each child a turn to repeat the sentence and add to the growing packing list.

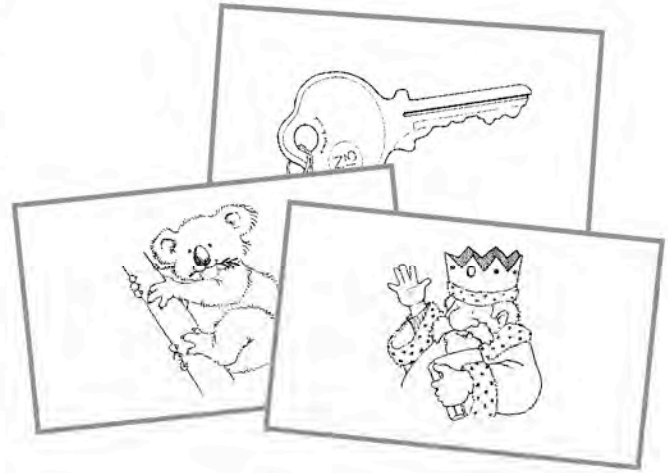

Movement

K Is for Kicks

Children will get a kick out of this activity! To prepare, make a set of letter cards, labeling most of the cards with an uppercase or lowercase *K*, and a few with other letters. During group time, ask children to lie on their tummies and demonstrate how they would kick if they were swimming. (Have them spread out so they have plenty of room to move their legs without kicking others around them.) Point out that *kick* starts with a *K*. Then ask children to look at each letter as you show the letter cards one at a time. Tell them that each time they see a *K*, they should kick their legs. If a card has a letter other than *K*, children should keep their legs still.

Snack **K Is for Kite**

These kites are just right for a simple snack that reinforces the letter *K*. Give children a 9-inch paper plate and about ten pretzel sticks. First, ask them to use three pretzel sticks to form the letter *K*. Then give children a square slice of American cheese. Have them transform their cheese slice into a kite by placing pretzel sticks on it to form the crossbars and tail of a kite, as shown. They can break the pretzels into shorter lengths, as needed, to make their kites. Then invite children to bite those kites!

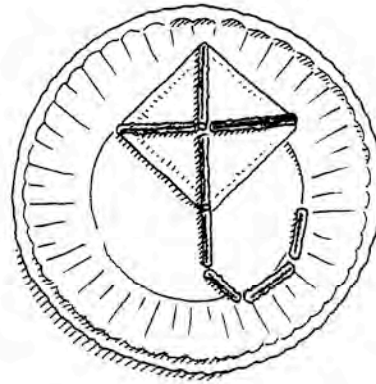

Literature **K Is for Kiss Kiss!**

Baby animals and their moms exchange kisses in *Kiss Kiss!* (Scholastic, 2003) by Margaret Wild and Bridget Strevens-Marzo. After reading this sweet story, invite children to throw a few kisses of their own with this activity that reinforces the beginning sound of *K*. Say aloud a list of words, in which most begin with *K*, and a few begin with other letters. Ask children to blow kisses your way whenever they hear a word that begins with *K*.

- Some words that begin with *K*:**
- kettle
 - kind
 - kitten
 - keep
 - ketchup
 - kiwi
 - kitchen
 - king

Letter *Kk* Mini-Book

Reinforce children's knowledge of the letter *K* and their letter-writing skills with this mini-book. First, duplicate a class supply of the mini-book patterns (page 73). Ask children to color the cover and pages, write their name on the cover, and trace the letters on page 5. Then have children cut apart the pages, stack them in order behind the cover, and staple the mini-book together in the upper left corner. Read the mini-book aloud as a class, emphasizing the beginning sound of *K* in the appropriate words. Then send the mini-books home for children to share with their family.



Kk

A B C D E F G H I J K L M

Letter K Picture Cards

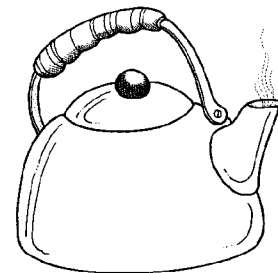
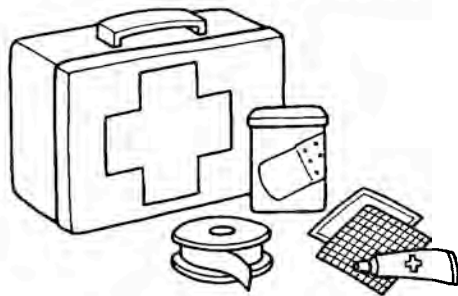
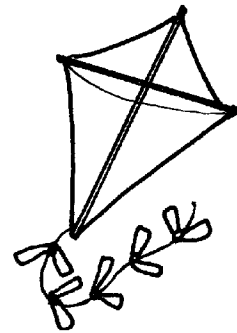
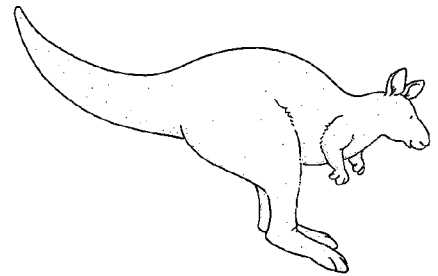

Kelly Kangaroo Likes...

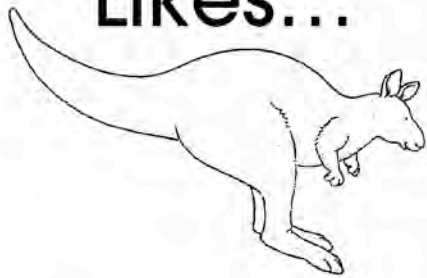

Name: _____



a **key**,

1

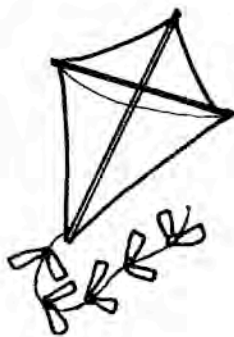

a **kite**,

2



a **king**,

3



a **kitten**,

4



and the letter **Kk!**

5

Introducing Ll

Before beginning your study of the letter *Ll*, remove the picture cards that begin with this letter (pages 209 and 211). Cut apart and laminate the cards for durability. Then write an uppercase and lowercase *L* on the chalkboard, or display a large letter card. Show children each picture card. As you name the picture, emphasize its beginning sound. Then point to and name the letter *L* on the board. Have children repeat the word and the sound of *L* at the beginning of the word. After reviewing, keep the cards on display and use them throughout your letter study.

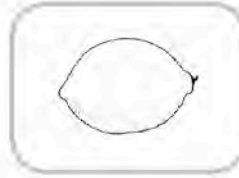
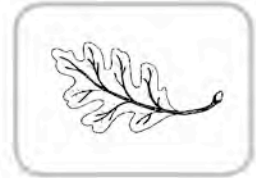
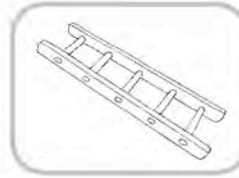

Math

L Is for Leaves

Leaves are lovely for some beginning practice with nonstandard measurement. Duplicate a supply of the leaf counters (page 77) onto green construction paper and cut them apart. Then, working with a small group, demonstrate how to use the leaf counters to properly measure an item—such as the tabletop—by placing the leaves end to end along the table edge. Have children help count the total number of leaves that were used to measure the tabletop. Then give children a pile of leaf counters and assign them different classroom items to measure. When they finish, gather children to share their results. To check the measurements, you might have the group measure each item together and then compare the group and individual results to each other.



Craft

L Is for Lollipop

These colorful lollipops look good enough to lick! To make a lollipop, have children spread some white glue in the center of a tagboard circle. Then give them a length of multicolor yarn. Help children place one end of the yarn in the center of the circle and then wrap the yarn around the center to make a spiral design, as shown. After getting the spiral started, have children add yarn (and glue) as needed, to make a yarn spiral that covers the entire circle. Once the glue is dry, ask children to tape a jumbo craft stick to the back of their lollipop to serve as the handle.

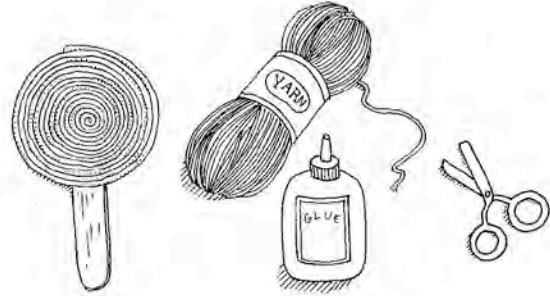

Game

L Is for Left

Ask children to hold up their left hand, extending their first finger and thumb, but closing all their other fingers. Do they notice that their fingers and thumbs now form a letter L? Tell them that they will make an L in this way and raise it into the air each time they hear you say a word that begins with the letter L. Then say aloud a list of words in which most begin with the letter L, and a few begin with other letters.

Some words that begin with L:

- lap
- lily
- loose
- learn
- look
- large
- lazy
- loop

Movement

L Is for Limbo

Bring out a long stick (a broom will do) for a game of Limbo. But add a letter L twist! Before children take their turn moving under the Limbo bar, ask them to name a word that begins with the letter L. How low can children go—and how many L words can they think of?

Snack

L Is for Limeade

Most children have probably tasted lemonade, but are they familiar with limeade? Invite them to help make some from scratch for a refreshing letter *L* treat! Work with children to squeeze the juice from about 10 limes. Then, in a two-quart pitcher, dissolve $\frac{3}{4}$ cup sugar in 1 cup of hot water. (You might use a sugar substitute.) Stir in the lime juice and add cold water to fill the pitcher. Serve the limeade over ice. For additional letter fun, you might set aside about a tablespoon of the lime juice before mixing the limeade. Dip a wide paintbrush into the juice and paint a large *L* onto a sheet of white copy paper. Point out that the *L* is nearly invisible. Then place the paper on a padded surface (such as a folded kitchen towel) and run a hot iron over it (a teacher's job, of course). Children will be amazed to see the letter *L* appear!



Literature

L Is for The Letters Are Lost

After reading aloud *The Letters Are Lost* (Puffin, 1999) by Lisa Campbell Ernst, “lose” some letters of your own for this story follow up! Make a set of cards on which each card is labeled with an uppercase or lowercase *L*. (Or use die-cut letters.) Hide the letters around your classroom, choosing places where children can easily find the letters. Then tell children that you’ve lost every *L* card in your set! Send them on a search to find the missing letters. After gathering all the letters, have children sort them into two groups—uppercase and lowercase letters.

Letter L/ Mini-Book

Reinforce children’s knowledge of the letter *L* and their letter-writing skills with this mini-book. First, duplicate a class supply of the mini-book patterns (page 78). Ask children to color the cover and pages, write their name on the cover, and trace the letters on page 5. Then have children cut apart the pages, stack them in order behind the cover, and staple the mini-book together in the upper left corner. Read the mini-book aloud as a class, emphasizing the beginning sound of *L* in the appropriate words. Then send the mini-books home for children to share with their family.



Leaf Counters

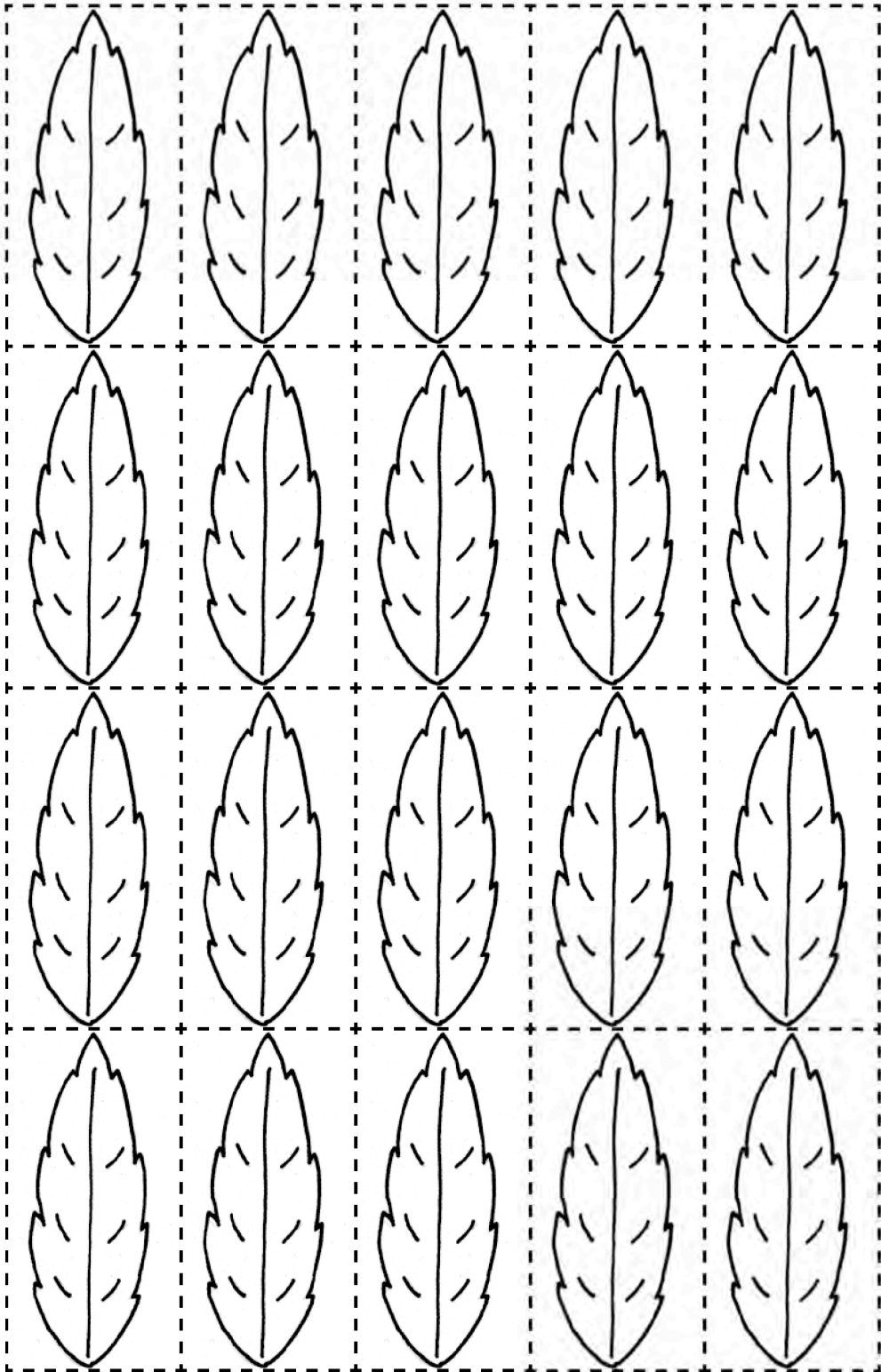

Louie Lion Likes...

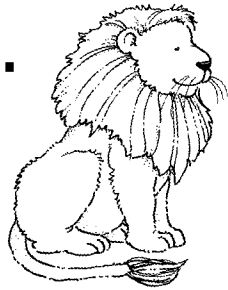

Name: _____

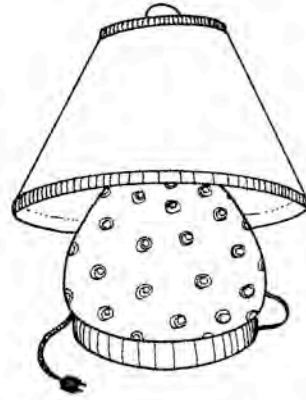

a lamp,

1

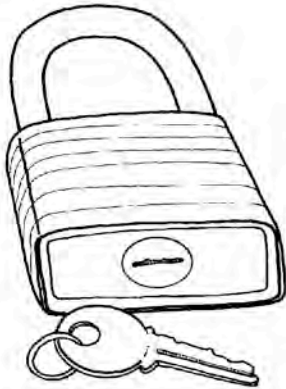

a lock,

2



a leaf,

3

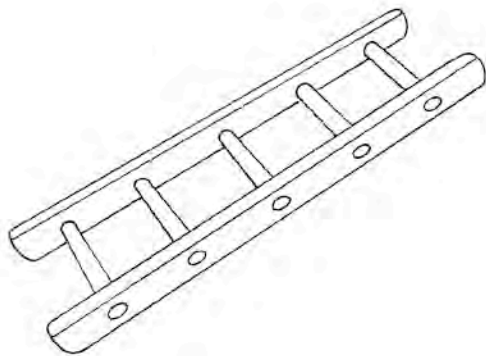

a ladder,

4



and the letter **L!**

5

Introducing Mm

Before beginning your study of the letter *Mm*, remove the picture cards that begin with this letter (pages 213 and 215). Cut apart and laminate the cards for durability. Then write an uppercase and lowercase *M* on the chalkboard, or display a large letter card. Show children each picture card. As you name the picture, emphasize its beginning sound. Then point to and name the letter *M* on the board. Have children repeat the word and the sound of *M* at the beginning of the word. After reviewing, keep the cards on display and use them throughout your letter study.

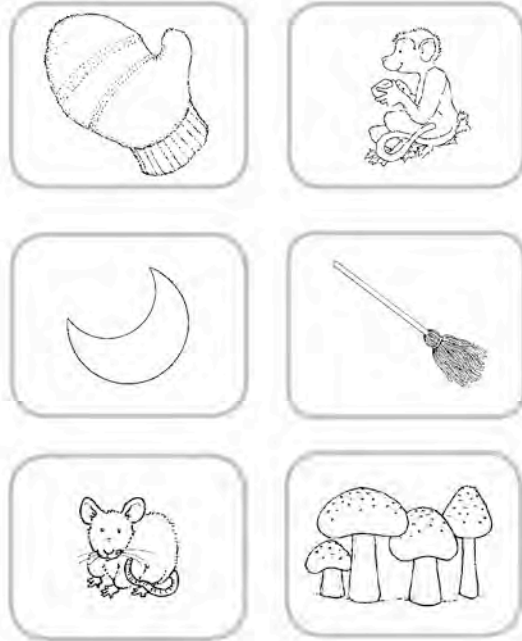

Math

M Is for Mittens

Whether it's winter or not, your little ones will love doing some mitten measuring! Duplicate the mitten counters on page 82 onto a few different colors of construction paper. Cut the counters apart and give a set to each child in a small group. Remind children how to properly measure the height or length of an object (such as a book or mitten) by placing the mitten counters end to end along the edge of the object. Then have children choose an object in the classroom to measure with their counters. If desired, have two or more children work together to measure a larger item, such as a bookshelf or countertop. Observe and question children as they work to evaluate their measurement skills.

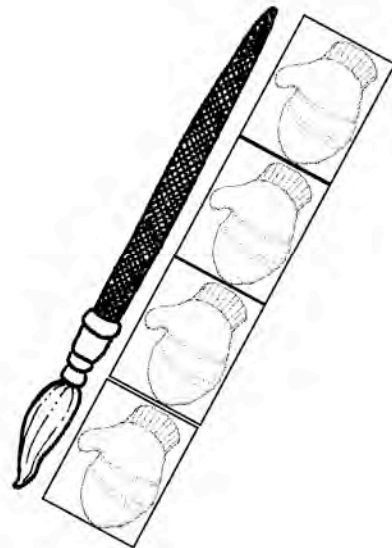

Craft

M Is for Monkey

Monkeys are marvelous for emphasizing the letter *M*! To prepare this cute monkey craft, duplicate a class supply of the monkey face pattern onto tan construction paper and the ear patterns onto dark brown construction paper. (See pattern on page 83.) Next, ask children to paint a 9-inch white paper plate dark brown. When the paint is dry, have children cut out their monkey face and ear patterns. Instruct them to draw features on the monkey face and glue it atop the plate. Finally, have children glue the monkey ears in place, as shown. To use the monkeys to reinforce the letter *M*, ask children to make up alliterative phrases with the word *monkey*, such as “my monkey munches melons.”



Game

M Is for Memory

Use a fun game of Memory to help children focus on the beginning sound of the letter *M*. Duplicate two copies of the picture cards on page 84. Color the pictures, cut the cards apart, and laminate them for durability. Then arrange the cards facedown in rows in a pocket chart. Invite children to take turns choosing and flipping over two cards at a time to try to find a match. If they find a match, children keep the cards. If not, they flip the cards back over in the chart. Continue play until children have found all of the matches. As children flip over each card to reveal the picture, say the word and emphasize the beginning sound of *M*.

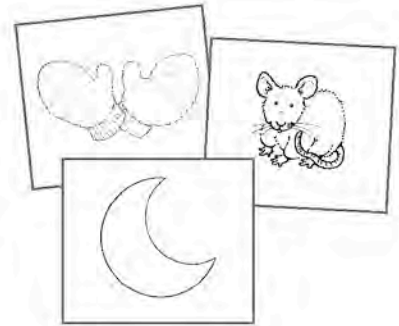

Movement

M Is for March

Get children moving and marching with this phonemic awareness activity. Say a list of words in which most begin with the letter *M*, and a few that begin with other letters. Each time children hear a word that starts with *M*, they should begin marching around the room. They keep marching until they hear a word that starts with a different letter.

Some words that begin with *M*:

mom
maze
mountain
maybe
mighty
million
marble
more

Snack

M Is for Mystery

Have children put on their thinking caps for this mystery snack! Bring in miniature muffins and milk to serve as a letter *M* snack—but keep the snack out of sight. Just before snack time, put a mini-muffin and cup of milk on a paper plate and drape a cloth napkin over the snack to hide it. Then present the mystery snack to children, explaining that they must guess what the snack for the day is. Invite them to ask questions to try to solve the mystery, or give children a few clues about the snack to help them guess. When children guess correctly, whisk the napkin away to reveal the mini-muffin and milk. Point out that *milk* and *muffin* both start with the letter *M*. Finally, serve this marvelous *M* snack to everyone!

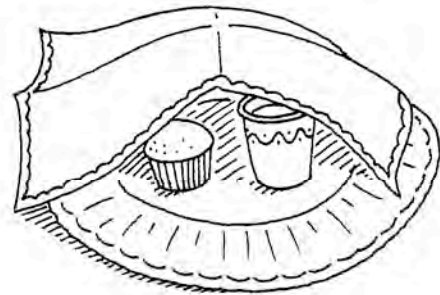

Literature

M Is for Mud

Read aloud *Mud* (Voyager Books, 2001) by Mary Lyn Ray and then try this tasty follow-up activity. For each child, put a few spoonfuls of chocolate pudding into a zippered plastic bag. Squeeze as much air as possible from each bag; then seal it well. Invite children to lay their bag flat on the tabletop and use their finger to practice “writing” an uppercase or lowercase *M* in this look-alike mud. When they finish their practice writing, provide plastic spoons and invite children to eat this “muddy-licious” treat!

Letter Mm Mini-Book

Reinforce children’s knowledge of the letter *M* and their letter-writing skills with this mini-book. First, duplicate a class supply of the mini-book patterns (page 85). Ask children to color the cover and pages, write their name on the cover, and trace the letters on page 5. Then have children cut apart the pages, stack them in order behind the cover, and staple the mini-book together in the upper left corner. Read the mini-book aloud as a class, emphasizing the beginning sound of *M* in the appropriate words. Then send the mini-books home for children to share with their family.

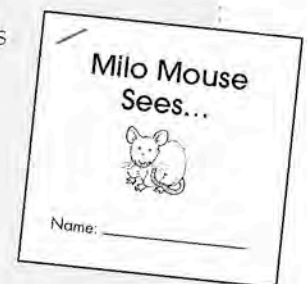

Mm

A B C D E F G H I J K L M

Mitten Counters

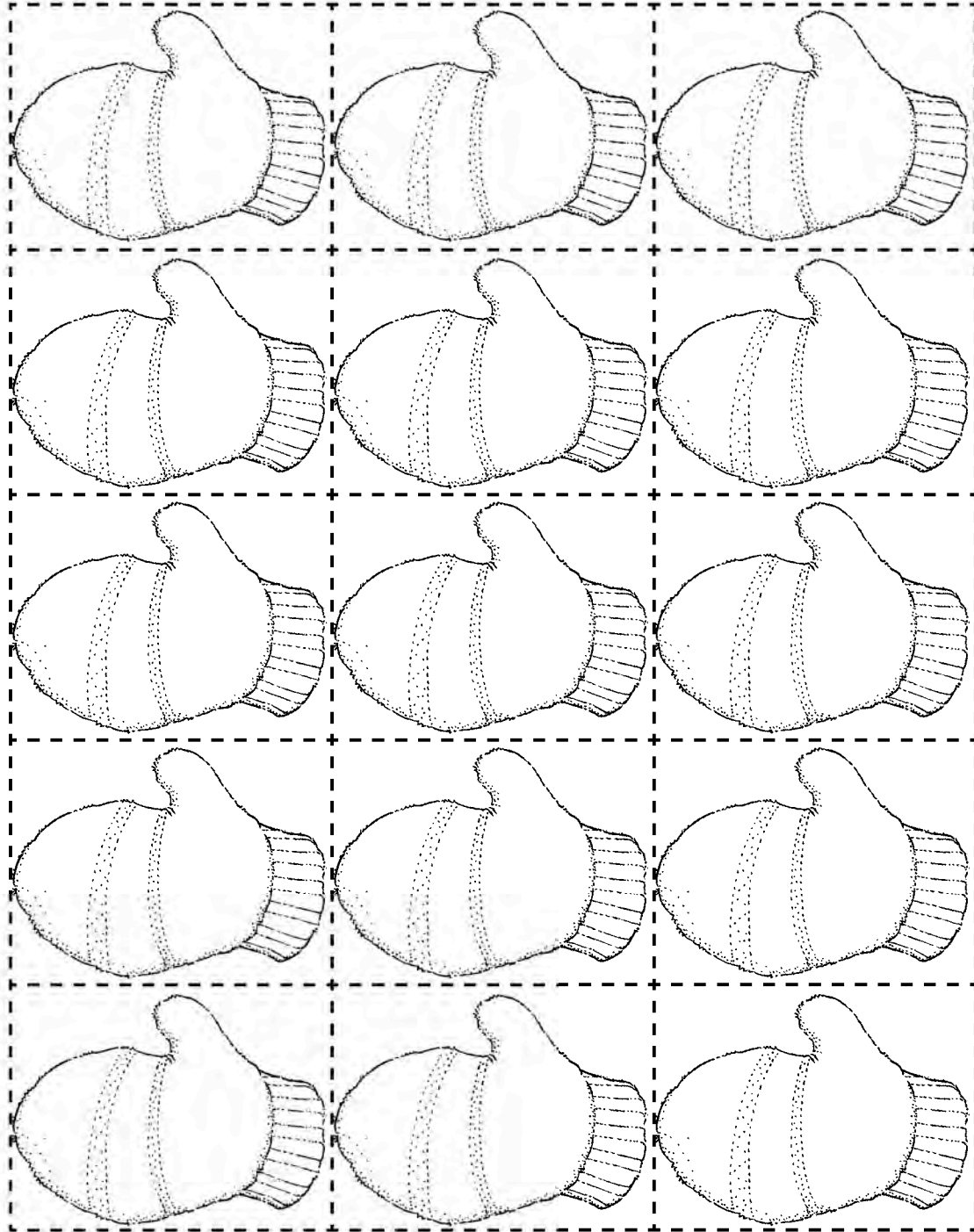

Monkey Patterns

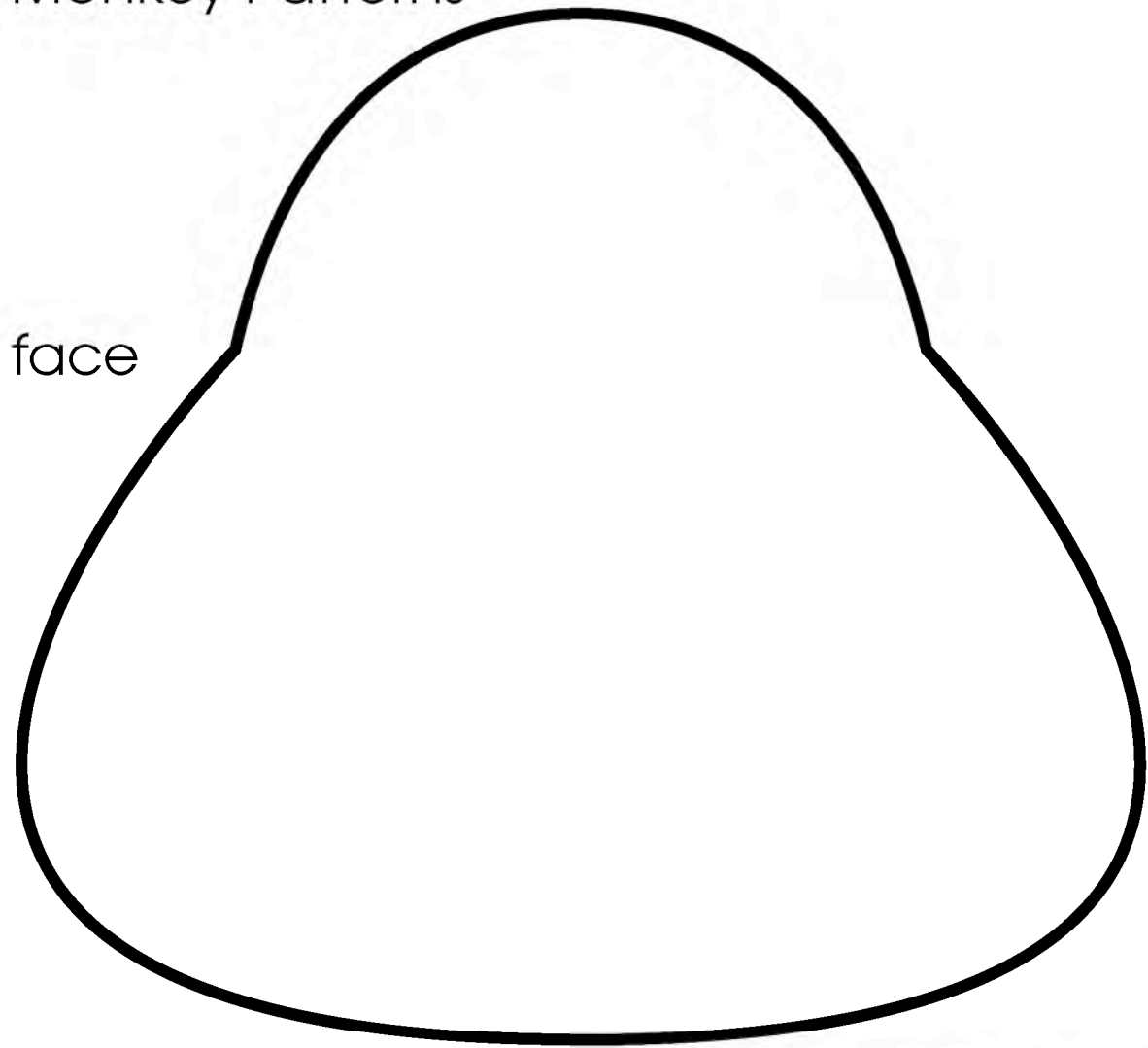

face

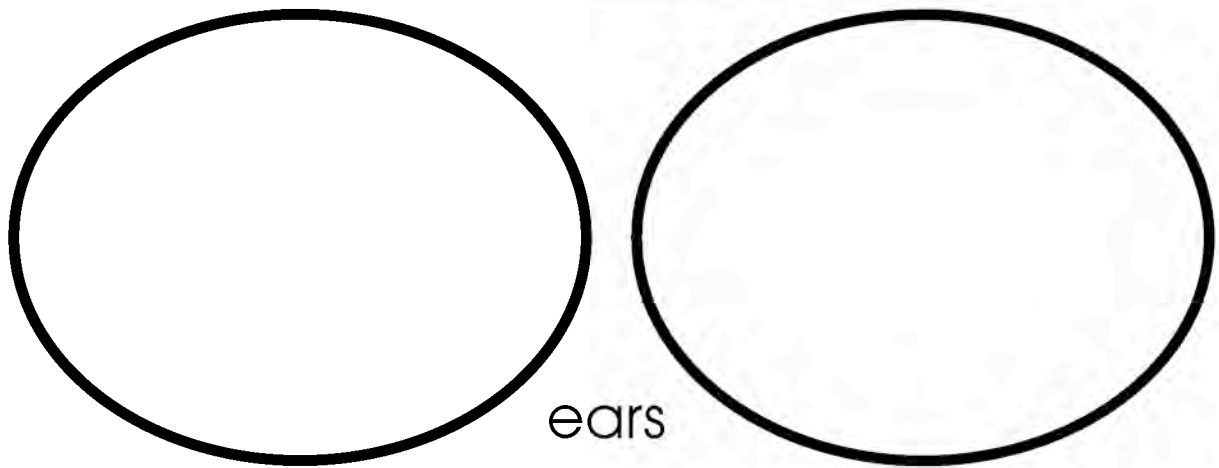

ears

Mm

A B C D E F G H I J K L M

Letter M Picture Cards

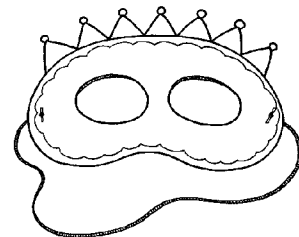
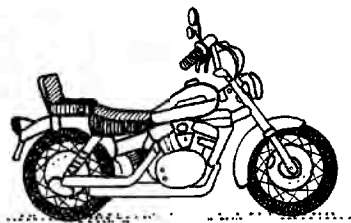
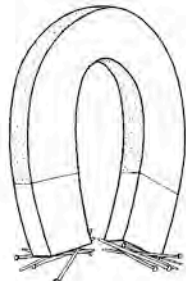
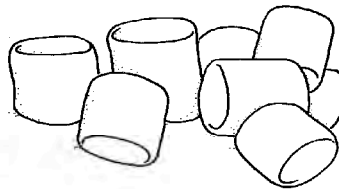
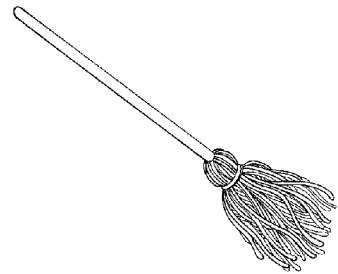
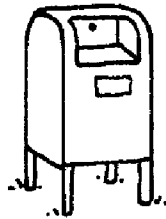
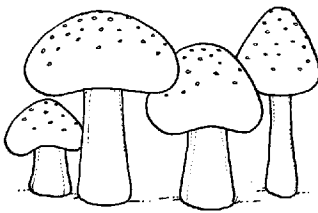
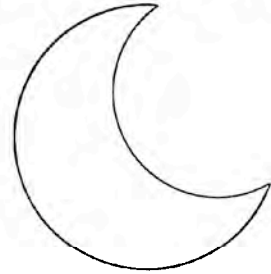
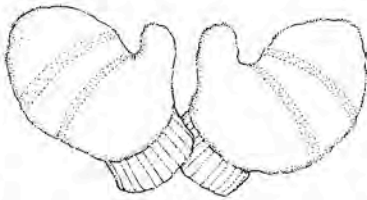

Milo Mouse Sees...



Name: _____



a **m**onkey,

1

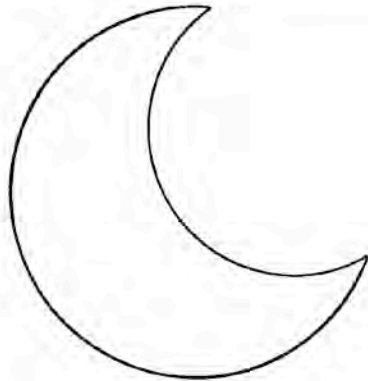

a **m**oon,

2

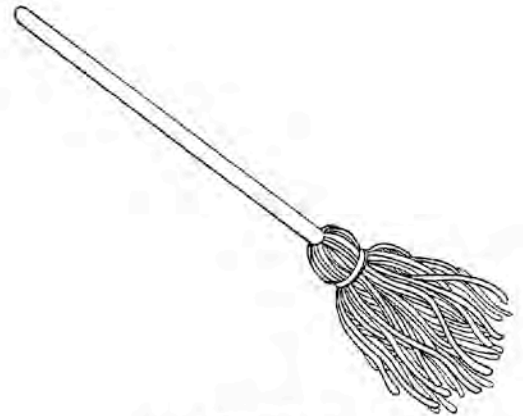

a **m**op,

3

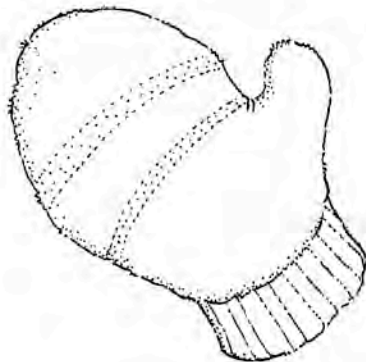

a **m**itten,

4



and the letter **Mm**!

5

Introducing Nn

Before beginning your study of the letter *Nn*, remove the picture cards that begin with this letter (pages 215 and 217). Cut apart and laminate the cards for durability. Then write an uppercase and lowercase *N* on the chalkboard, or display a large letter card. Show children each picture card. As you name the picture, emphasize its beginning sound. Then point to and name the letter *N* on the board. Have children repeat the word and the sound of *N* at the beginning of the word. After reviewing, keep the cards on display and use them throughout your letter study.

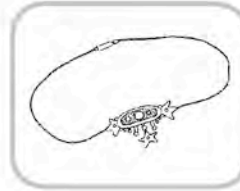

Math

N Is for Newspaper Numbers

Ask children what the words *newspaper* and *numbers* have in common. It's the letter *N* at the beginning of each word, of course! Then have children work together in small groups to search newspaper advertisements, such as grocery store flyers, to find an example of each number from 1 to 10. Have them cut out the numbers and glue them to a sheet of paper in sequential order.

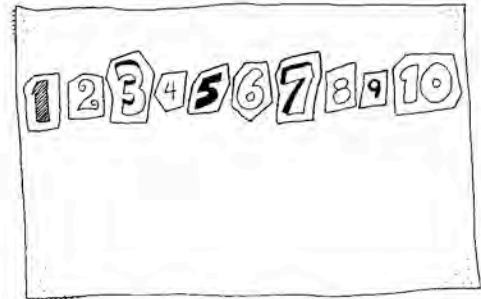

Craft

N Is for Name Necklaces

Children will enjoy sporting these name necklaces. To prepare, duplicate a supply of the letter bead patterns (page 89) onto different colors of construction paper. Cut the beads apart and place them in a flat box. Then, working with small groups, help children find the letters they need to spell out their name. To make a necklace, have them fold their paper beads in half and then glue them, in sequence, to a 26-inch length of yarn, as shown. When finished, help children tie the ends of their yarn together to complete their necklace. As they put on their necklaces, remind them that *necklace* begins with the sound of *N*. Challenge them to point out any names of children that also begin with *N*.



Game

N Is for Nuts

Play a pocket-chart game of “Oh, Nuts!” for letter-recognition practice. Duplicate the game cards on page 90 onto tagboard. Color the picture, cut the cards apart, and laminate them, if desired. Then display the cards facedown in one row of a pocket chart. To use with a small group, invite children to take turns flipping over the cards, from left to right. As they reveal the printed side of each card, have them name the type of letter on it, for example, “uppercase *N*” or “lowercase *n*.” If they find the nut card before they reach the end of the row, they exclaim, “Oh, nuts!” and the turn ends.

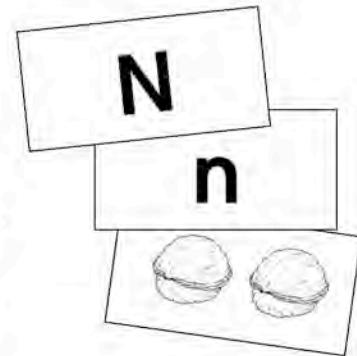

Movement

N Is for Noodles

N is for noodles—in this case, *pool* noodles! Bring in three foam pool noodles for some movement fun. (If you don’t have pool noodles, you might borrow them from the P.E. teacher, a coworker, or parent.) Use the pool noodles for a series of relay races. For example, divide the class into three teams, give each one a pool noodle, and have children on each team line up one behind the other. On a signal, instruct the team members to pass their noodle from the front to the back of the line in an alternating fashion, over their head and then between their legs. Or set plastic cones at one end of an open area and line up teams at the opposite end. Then invite members of each team to “ride” their noodle (like a stick horse) to and around their assigned cone and back to pass it to the next child, relay style. Or pair up children and time the pairs as they take turns arranging the three noodles to form an *N*. Fastest time wins!

Snack

N Is for Nutritious N

For this activity, outline a block letter *N* on a 9-inch paper plate for each child. Prepare several kinds of vegetables, such as cucumber slices, carrot rounds, cherry tomato halves, and red pepper strips, and put these in small bowls. Then talk with children about the word *nutritious* and its beginning letter, *N*. Ask them to name some foods that are full of nutrition. Afterward, pass a paper plate and vegetable bowl to children and have them fill up their *N* outline with veggies. Finally, invite children to nosh this nutritious snack!



Literature

N Is for Noisy Nora

After reading *Noisy Nora* (Puffin, 2000) by Rosemary Wells, invite children to make some noise of their own with this follow-up activity. Say a list of words, most of which begin with the letter *N*, and a few which begin with other letters. Tell children to make noise—yelling, banging, clapping, stomping, or any combination they choose!—whenever they hear a word that begins with the sound of *N*. Ask children to stay very quiet if they hear a word that begins with any other letter sound.

Some words that begin with N:

- never
- navy
- no
- number
- need
- north
- nice

Letter Nn Mini-Book

Reinforce children's knowledge of the letter *N* and their letter-writing skills with this mini-book. First, duplicate a class supply of the mini-book patterns (page 91). Ask children to color the cover and pages, write their name on the cover, and trace the letters on page 5. Then have children cut apart the pages, stack them in order behind the cover, and staple the mini-book together in the upper left corner. Read the mini-book aloud as a class, emphasizing the beginning sound of *N* in the appropriate words. Then send the mini-books home for children to share with their family.



Letter Bead Patterns

A	B	C	D	E	F
G	H	I	J	K	L
M	N	O	P	Q	R
S	T	U	V	W	X
Y	Z				

Nn

A B C D E F G H I J K L M

“Oh, Nuts!” Game Cards

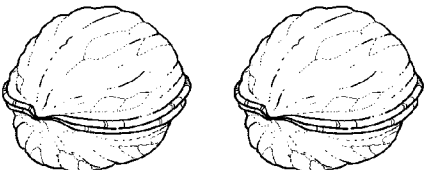
N	N
N	N
N	n
n	n
n	

Nora Nurse Has...



Name: _____

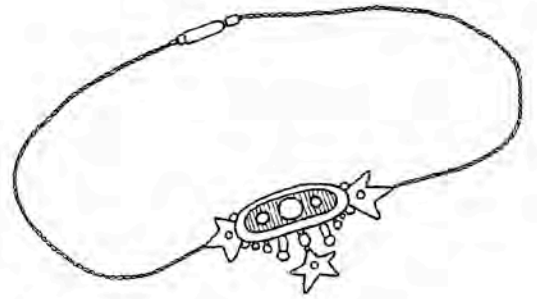

a **n**ecklace,

1

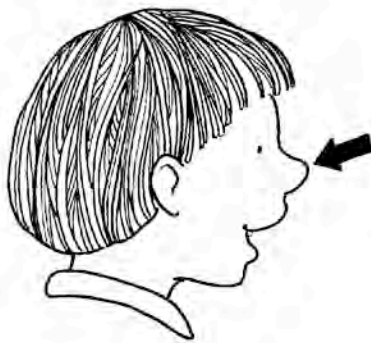

a **n**ose,

2



a **n**ine,

3



a **n**est,

4



and the letter **Nn!**

5

Oo

A B C D E F G H I J K L M

Introducing Oo

Before beginning your study of the letter *Oo*, remove the picture cards that begin with this letter (pages 219 and 221). Cut apart and laminate the cards for durability. Then write an uppercase and lowercase *O* on the chalkboard, or display a large letter card. Show children each picture card. As you name the picture, emphasize its beginning sound. Then point to and name the letter *O* on the board. Have children repeat the word and the sound of *O* at the beginning of the word. After reviewing, keep the cards on display and use them throughout your letter study.

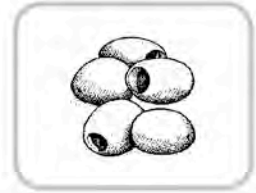
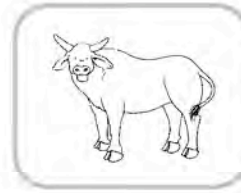
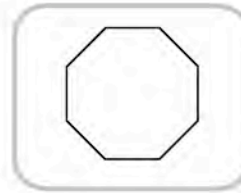

Math

O Is for Olives

To help children practice number order, duplicate the jar pattern (page 95) onto white construction paper and the olive cards (page 96) onto green construction paper. Cut out the jar and cards and laminate them for durability. Working with a pair or trio of children, put all of the olives in a random arrangement on the jar. Point out that *olive* begins with the short sound of *O*. Then explain to children that they will take turns removing one olive at a time—from the lowest to highest number—from the jar. As they take off each card, have children line up the cards on the tabletop in numerical order.

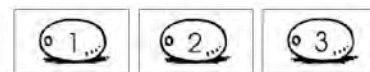
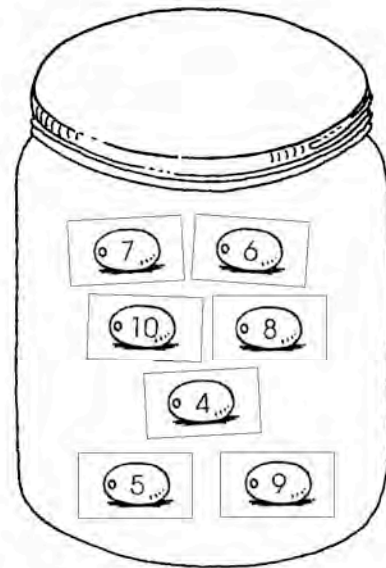

Craft

O Is for Octopus

These cheery octopus windsocks will brighten your classroom from overhead! For each child, cut a 7- by 18-inch strip of colored construction paper in the shape shown. Also cut eight 1- by 9-inch strips from a second color of construction paper. Then have children draw a face on the large paper strip to represent an octopus. To make tentacles, have children stick white dot stickers or hole reinforcers along the length of their eight thin strips. Help children roll each tentacle loosely around their finger to give it a slight curl. Then have them glue one end of each tentacle to the back of the octopus. To complete their windsock, staple the ends of the large octopus together to form a tube. Punch two holes opposite each other at the top of the octopus and add a yarn hanger to prepare the project for display.



Game

O Is for On and Off the Octagon

Children listen for the short sound of O in this game. Cut out a large octagon from colorful construction paper for each child. Laminate the octagons for durability. Have children place their octagon on the floor in an open area. Ask them to stand next to their shape. Then say a list of words, some of which begin with the short sound of O and others that begin with different letters. If children hear a word beginning with O, they step *on* their octagons. If they hear a word that starts with another letter, they step *off* their octagons.

Some words that begin with O:

- | | |
|-----------|-------------|
| operation | ox |
| odd | opportunity |
| offer | octopus |
| olive | ostrich |

Movement

O Is for O Poem

For this movement activity, take children to a large open area and give them a plastic hoop to represent the letter O. (If your space is limited, you might have children use their hands to form a letter O.) Then teach children this poem, inviting them to move their O according to the directions in the verse. When they reach the last line, children can roll their hoop away. (If they are using their hands, have them find a creative way to “hide” their O at the end.)

O goes up, O goes down.
 Make your O turn all around.
 O to the left; O to the right.
 Make your O go out of sight!

Oo

A B C D E F G H I J K L M

Snack

O Is for Operation O Taste Test

Not many foods begin with the short sound of *O*, but there are some foods shaped like the letter *O*! Bring in three of those for children to sample: black olive slices, cereal oat rings, and pineapple rings. Put a few olives, cereal rings, and a pineapple ring on plates to serve to children. Ask them to name each food and tell which one starts with the short sound of *O*. Then begin Operation *O* Taste Test by having children taste each food and mark on a chart which one they prefer. Which *O*-shaped food is the class favorite?

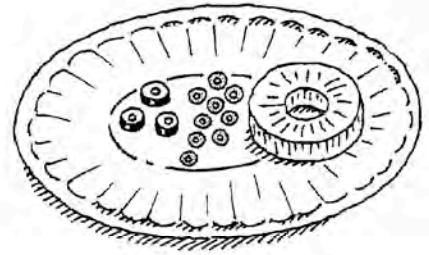

Literature

O Is for Exactly the Opposite

Help children explore the concept of opposites with Tana Hoban's *Exactly the Opposite* (Greenwillow Books, 1997). After sharing the book, point out that *opposite* begins with the short sound of *O*, as do one set of popular opposites, *on* and *off*. Then try this flashy follow up activity featuring that opposite pair. Ask children to name words that begin with the short sound of *O*. When they successfully name an *O* word, turn the classroom lights off. When the next *O* word is named, turn the lights on again. Continue turning the lights on and off as children come up with words that begin with the short *O* sound!

Letter Oo Mini-Book

Reinforce children's knowledge of the letter *O* and their letter-writing skills with this mini-book. First, duplicate a class supply of the mini-book patterns (page 97). Ask children to color the cover and pages, write their name on the cover, and trace the letters on page 5. Then have children cut apart the pages, stack them in order behind the cover, and staple the mini-book together in the upper left corner. Read the mini-book aloud as a class, emphasizing the beginning sound of *O* in the appropriate words. Then send the mini-books home for children to share with their family.



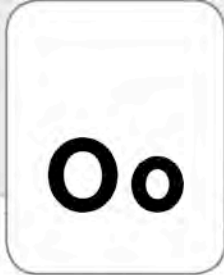



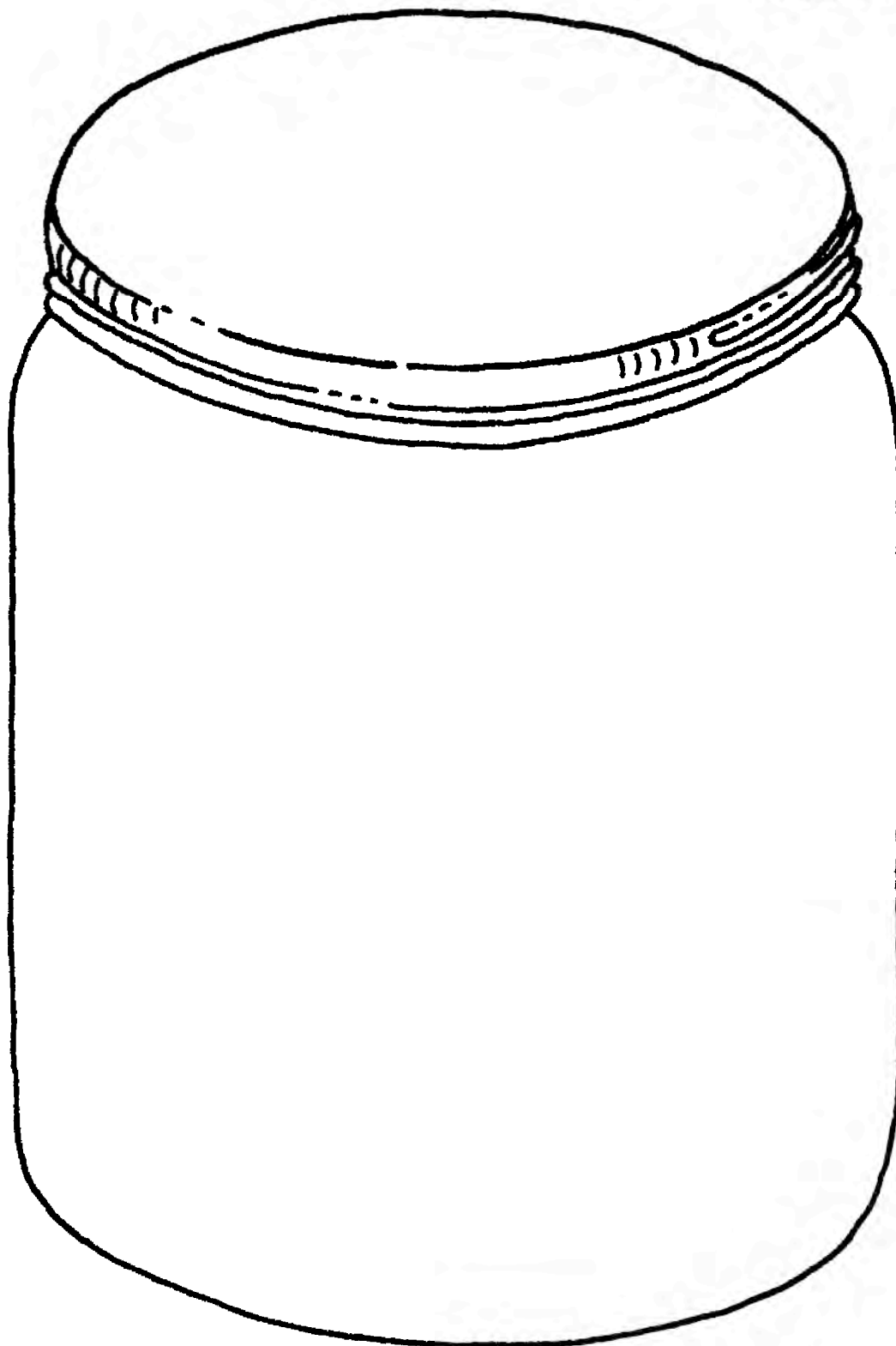







Jar Pattern



Oo

A B C D E F G H I J K L M

Olive Cards

Omar Octopus Likes...



Name: _____



an **o**live,

1

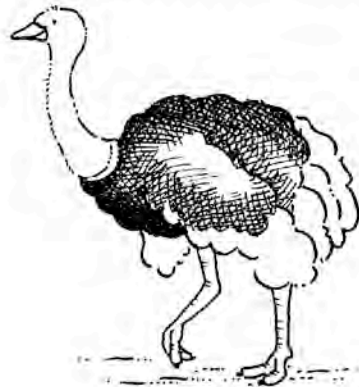

an **o**strich,

2

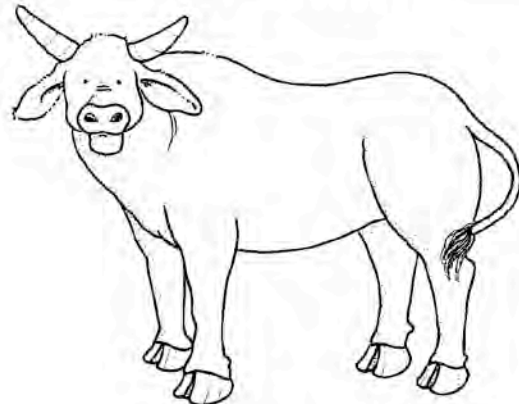

an **o**x,

3

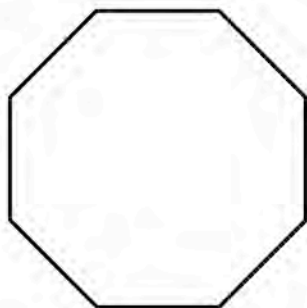

an **o**ctagon,

4



and the letter **Oo!**

5

Introducing Pp

Before beginning your study of the letter Pp, remove the picture cards that begin with this letter (pages 221 and 223). Cut apart and laminate the cards for durability. Then write an uppercase and lowercase P on the chalkboard, or display a large letter card. Show children each picture card. As you name the picture, emphasize its beginning sound. Then point to and name the letter P on the board. Have children repeat the word and the sound of P at the beginning of the word. After reviewing, keep the cards on display and use them throughout your letter study.

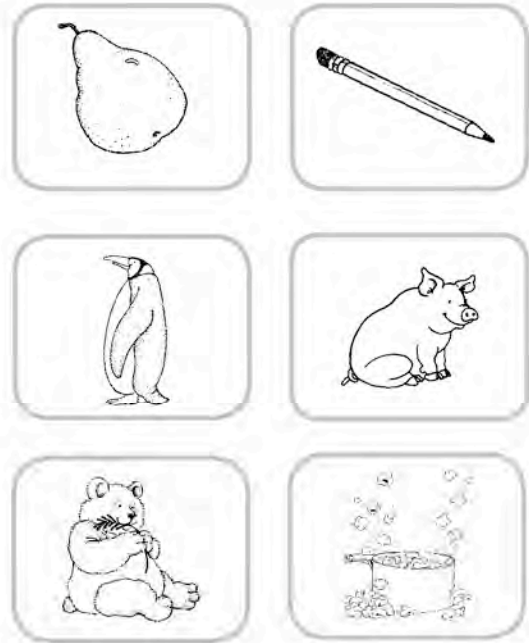

Math

P Is for Pet Patterns

Dogs, cats, fish—they all start with P...because they're all pets, of course! Make two or three copies of the pet cards (page 101) and cut them apart. Working with a small group, choose the cards for two different pets and lay out a simple ABAB pattern (such as *dog, fish, dog, fish*). Have a child identify the pattern and then extend it with more cards. After children make a few different patterns this way, give them a 4- by 12-inch strip of colored construction paper and a copy of the pet cards. Invite them to cut out and color the animals they wish to use to create a pattern and then glue the pattern to their paper strip.

Craft

P Is for Pear

This pear-in-a-square is a cinch to make! To prepare, cut a class supply of 9-inch squares of both white and black construction paper. Cut a pear shape from the center of each black square. Then bring in a real pear for children to examine. Point out that *pear* begins with the letter P. Next, give children the white construction-paper squares and yellow and green chalk. Have them color their paper with both colors of chalk. Then ask them to rub their fingers over the chalk to blend the two shades. Finally, have children glue a black paper square over their chalk art to create a pear silhouette.

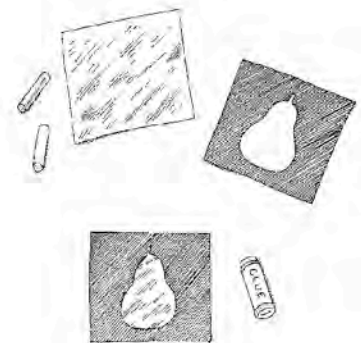

Game

P Is for Pizza

Children will eat up beginning sound practice when they play Pizza Lotto! To prepare, duplicate the pizza game boards (pages 102–103) onto tagboard. Color and cut out the game boards, then laminate them for durability. Invite children in a small group to take a game board and five red plastic bingo markers to represent pepperoni. (Or cut out and laminate red tagboard circles to use for pepperoni.) To play, call out the name of one of the pictures on a game board. (All of the picture names begin with a *P*.) If children have that picture on their game board, they cover it with a pepperoni marker. The first child to cover all the pictures on his or her game board calls out, “*P Is for Pizza!*” and wins the game.

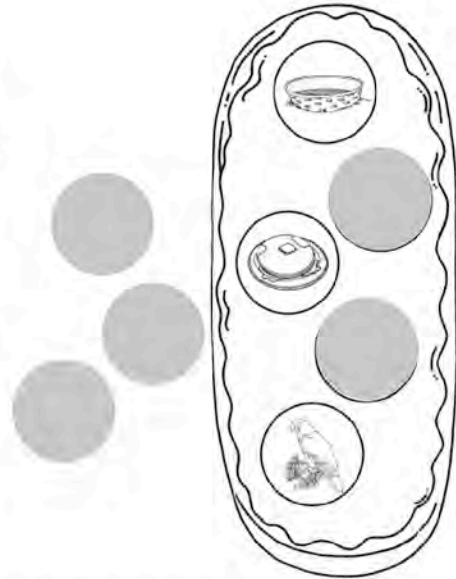

Movement

P Is for Popcorn

Have a popping-good time listening for the sound of *P* with this activity! First, have children crouch down low and then jump up to pretend they are popcorn cooking in a pot. Tell them that they will “pop” like this whenever they hear you say a word that begins with the sound of *P*. Then say a list of words, most of which begin with the sound of *P*, and a few that begin with other sounds. Popping popcorn has never been so much fun!

Some words that begin with *P*:

peel
pen
pull
puzzle
purple
parrot
pebble
pour

Snack

P Is for Pancakes

There are lots of kid-friendly foods that begin with the letter *P*, and pancakes have to be near the top of the list! Emphasize this letter further by making a batch of pancakes in the shape of a *P*! Simply pour some pancake batter into a squeeze bottle. Then squeeze the batter (prepared ahead of time) onto a hot electric griddle to make pancakes in the shape of a *P*. (Supervise children closely and keep them a safe distance away from any hot appliance!) When the pancakes are ready, carefully flip them so they can brown on the other side. With a bit of sugar-free syrup, these pancakes make a letter-perfect snack!

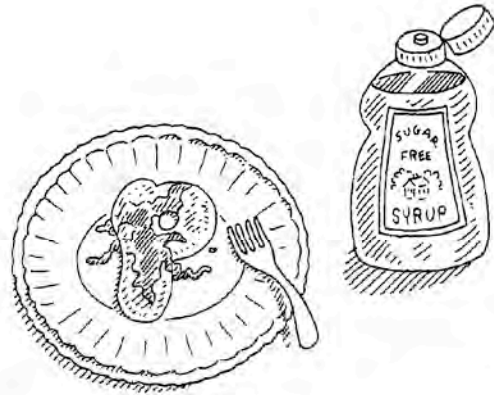

Literature

P Is for Pinkalicious

After reading aloud *Pinkalicious* (HarperCollins, 2006) by Victoria Kann and Elizabeth Kann, put some pink markers in the hands of children. Give them white paper and have them practice writing both the uppercase and lowercase forms of the letter *P*. Then ask children to draw some items that begin with *P*, such as pigs, puppies, pies, penguins, puddles, or people. It's a celebration of all things pink and all things that start with *P*!

Letter Pp Mini-Book

Reinforce children's knowledge of the letter *P* and their letter-writing skills with this mini-book. First, duplicate a class supply of the mini-book patterns (page 104). Ask children to color the cover and pages, write their name on the cover, and trace the letters on page 5. Then have children cut apart the pages, stack them in order behind the cover, and staple the mini-book together in the upper left corner. Read the mini-book aloud as a class, emphasizing the beginning sound of *P* in the appropriate words. Then send the mini-books home for children to share with their family.

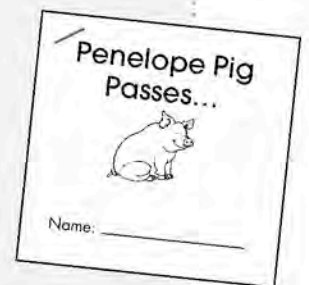

Pet Cards

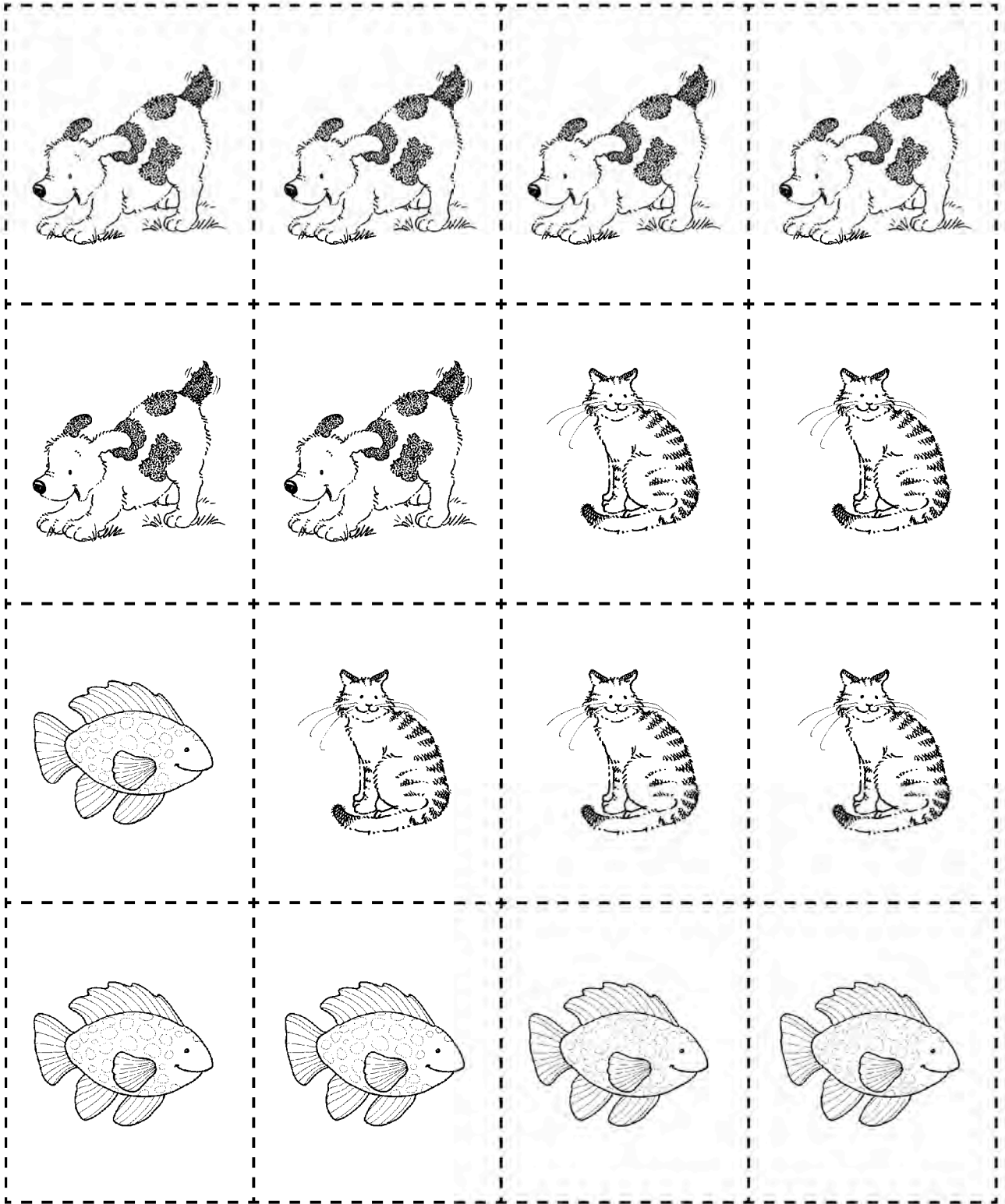

Pp

A B C D E F G H I J K L M

Pizza Game Boards

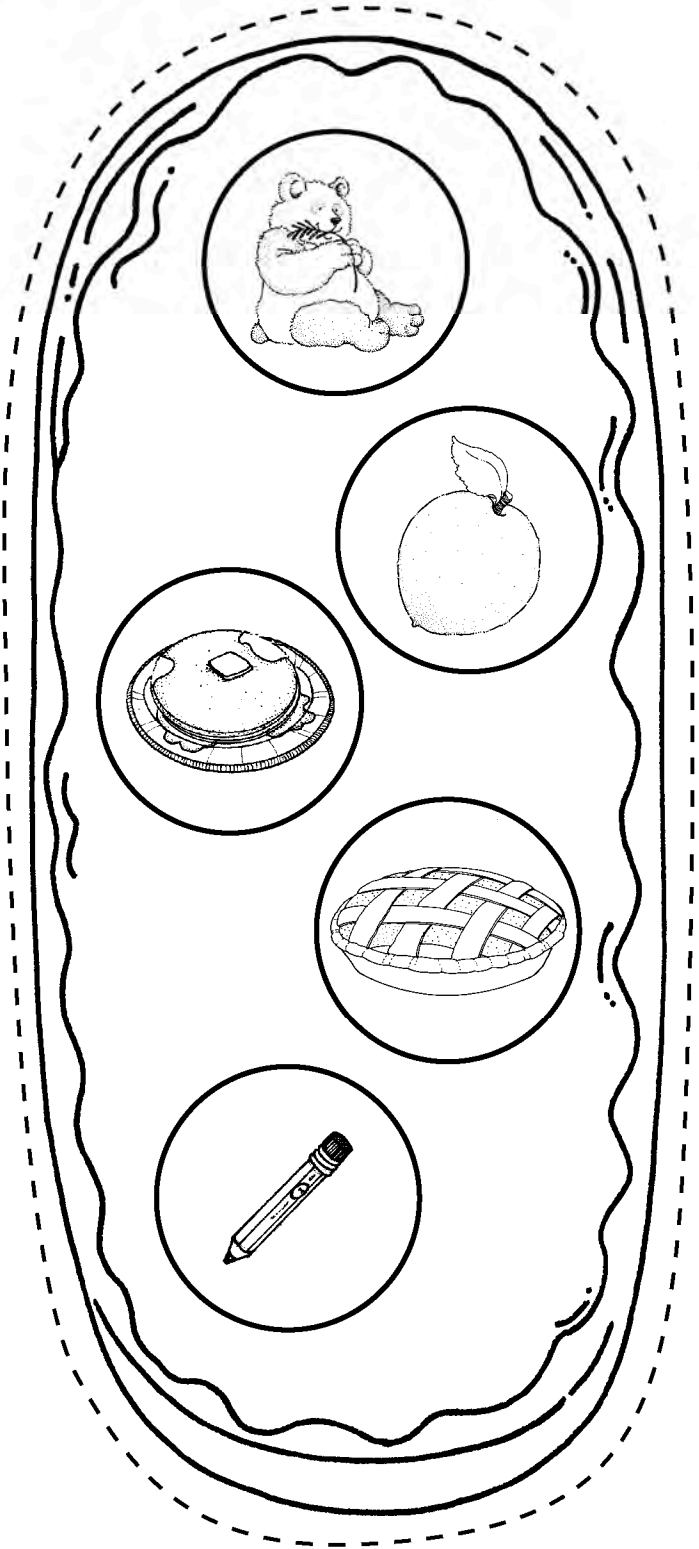
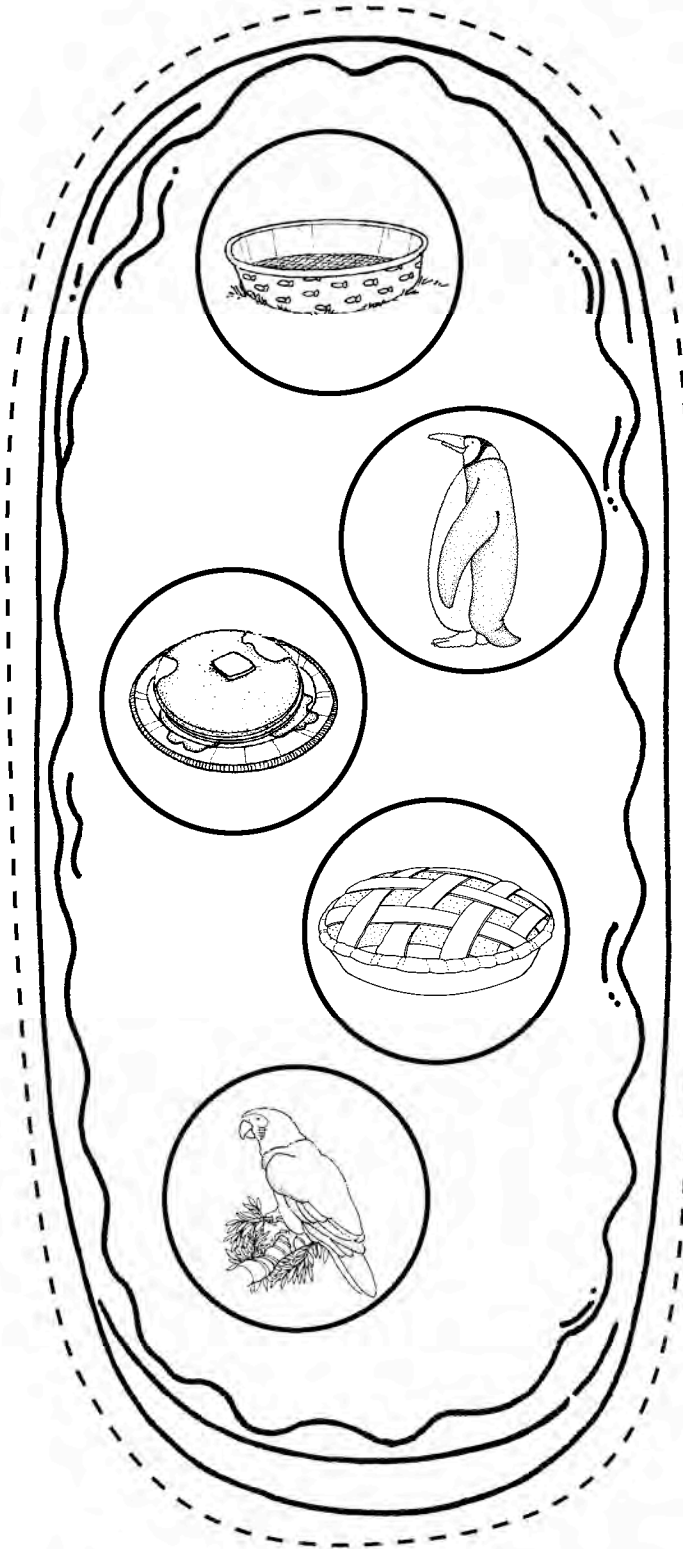

Pizza Game Boards

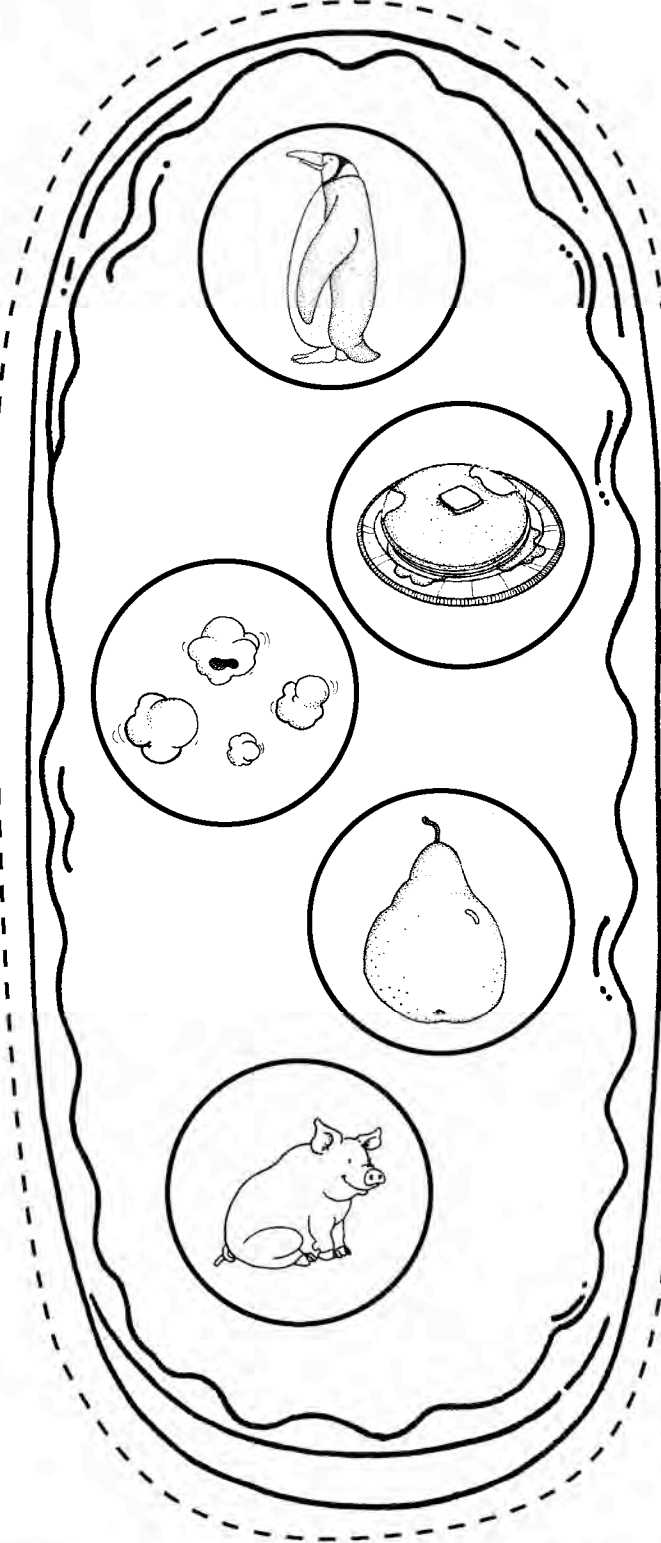
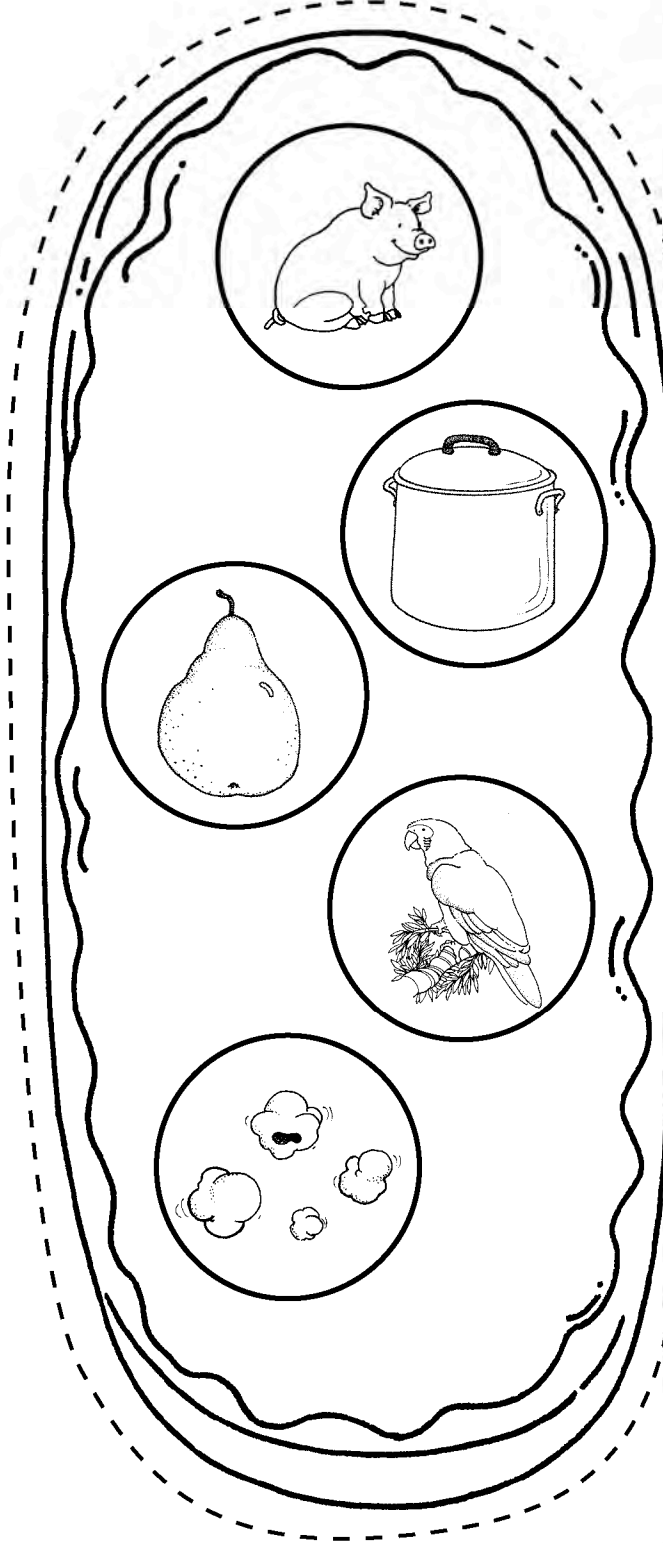

Penelope Pig Passes...

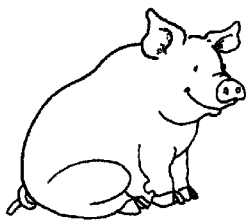

Name: _____



a **p**encil,

1



a **p**anda,

2

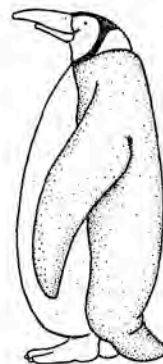

a **p**enguin,

3



popcorn,

4



and the letter **Pp**!

5

Introducing Qq

Before beginning your study of the letter *Qq*, remove the picture cards that begin with this letter (pages 225 and 227). Cut apart and laminate the cards for durability. Then write an uppercase and lowercase *Q* on the chalkboard, or display a large letter card. Show children each picture card. As you name the picture, emphasize its beginning sound. Then point to and name the letter *Q* on the board. Have children repeat the word and the sound of *Q* at the beginning of the word. After reviewing, keep the cards on display and use them throughout your letter study.



Math

Q Is for Queen's Crown

Children practice patterning and writing the letter *Q* when they make this crown fit for a queen! Give children a 22-inch strip of scalloped bulletin board border. Have them use a permanent marker to write a letter *Q* on the left end of the strip. Then have them stick a plastic craft jewel to the right of the letter. Tell children to continue writing a *Q* and then adding a jewel in an ABAB pattern across the length of the strip. When finished, fit children's pattern strip around their head and staple the ends together to make a crown.

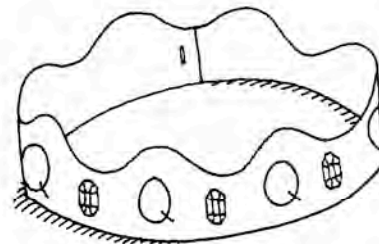

Craft

Q Is for Quilt

These Q-tips® quilt squares are quick and easy to make! First, give children a 6-inch square of white construction paper. Then provide watercolors and a supply of Q-tips® Cotton Swabs for children to use to paint their square however they wish. Once dry, display all of the squares in a grid pattern to create a large quilt on a wall or bulletin board. You might add strips of solid-colored construction paper around the edges to add a finished look to this quaint quilt!

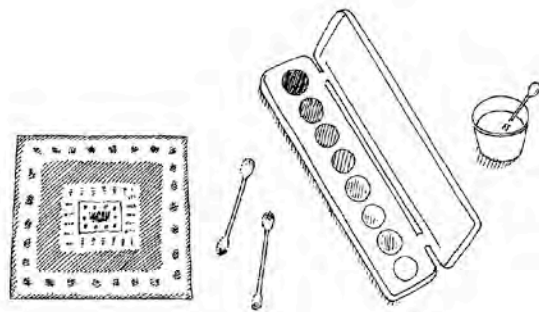

Game

Q Is for Question Mark

Invite children to listen for the beginning sound of Q with this quick and easy game. First give children paper and crayons. Have them practice drawing a question mark, demonstrating how to do this if necessary. Then, before beginning this activity, tell children to turn their papers over to the blank side. To play, say aloud a list of words, some of which begin with the letter Q and some that begin with other letters. Ask children to draw a question mark on their paper each time they hear a Q word. When you finish naming words, have children count the question marks on their papers. Announce the correct number of Q words that you listed and see if children heard them all.

Some words that begin with Q:

- quack
- quiz
- quart
- quote
- quilt
- quite
- quill
- quit

Movement

Q Is for Quarter

Children will quickly learn how to make heads or tails of this game! Show them a quarter and explain which side of the coin is called “heads” and which is called “tails.” Then use the quarter for a movement activity. Invite children to take turns naming an action the class might perform—such as toe touches, jumping jacks, or running in place. Then have them flip the quarter. If it lands on heads, the class performs the named action five times (or for a count of five). If the quarter lands on tails, children remain still and the next child takes a turn.

Snack

Q Is for Quick Quesadillas

Ask children if they have ever eaten a quesadilla. Explain that *quesadilla* starts with a *Q*, but since it's a Spanish word, the beginning sound is pronounced like a *K*. Then help children make these quick quesadilla snacks. To begin, give children a flour tortilla on a paper plate. Have them sprinkle a handful of shredded Mexican cheese blend on one half of their tortilla and then fold it over. Place the folded tortillas on a hot, greased electric griddle. (Supervise children closely and keep them a safe distance away from any hot appliance!) After a few minutes, flip them to brown the other side. When cooled, slice each quesadilla into four wedges and serve. To further emphasize the letter *Q*, help children squirt taco sauce from a squeeze bottle onto their plate to form a *Q*. Mmm...quite tasty!

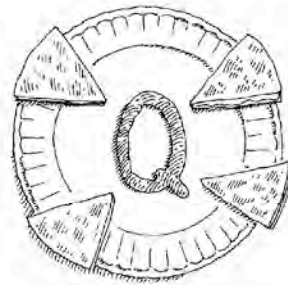

Literature

Q Is for The Very Quiet Cricket

After reading aloud *The Very Quiet Cricket* (Philomel, 1990) by Eric Carle, challenge children to see if they, too, can be very quiet. First, cut a letter *Q* from tagboard. Then seat children in a circle and tell them to be as quiet as possible. Next, pass the letter *Q* to a child who is sitting very quietly. Ask that child to then pass the letter to another child who is being very quiet. Continue the activity in this way to see how many times the letter can be passed—and how long children can manage to stay very quiet!

Letter Qq Mini-Book

Reinforce children's knowledge of the letter *Q* and their letter-writing skills with this mini-book. First, duplicate a class supply of the mini-book patterns (page 108). Ask children to color the cover and pages, write their name on the cover, and trace the letters on page 5. Then have children cut apart the pages, stack them in order behind the cover, and staple the mini-book together in the upper left corner. Read the mini-book aloud as a class, emphasizing the beginning sound of *Q* in the appropriate words. Then send the mini-books home for children to share with their family.



Queen Quella Has...



Name: _____



a **q**uarter,

1



a **q**uail,

2



a **q**uestion mark,

3

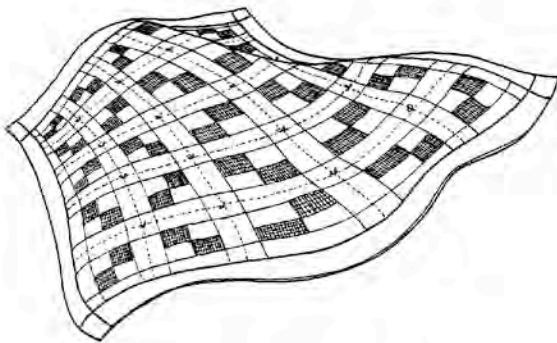

a **q**uilt,

4



and the letter **Qq!**

5

Introducing Rr

Before beginning your study of the letter *Rr*, remove the picture cards that begin with this letter (pages 227 and 229). Cut apart and laminate the cards for durability. Then write an uppercase and lowercase *R* on the chalkboard, or display a large letter card. Show children each picture card. As you name the picture, emphasize its beginning sound. Then point to and name the letter *R* on the board. Have children repeat the word and the sound of *R* at the beginning of the word. After reviewing, keep the cards on display and use them throughout your letter study.

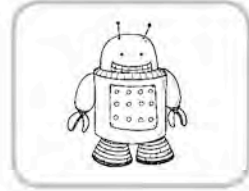
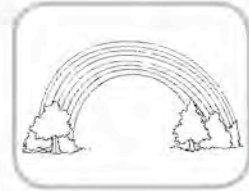

Math

R Is for Rabbit

Rabbits will hop on, under, next to, and behind things in this activity that lets children practice positional words. Have children color and cut out a tagboard copy of the rabbit pattern on page 112. Help them tape a craft-stick handle to the back of their rabbit. Then point out that *rabbit* begins with the letter *R*. To use, instruct children to move their rabbit puppet in ways to demonstrate understanding of different positional concepts. For example, you might tell them to bounce their rabbit *around* a chair, hold it *above* their head, hide it *behind* their back, seat it *beside* a classmate, or hold it *in front of* their tummy. Each time you give a direction, emphasize the word or phrase used to describe the positional concept. You might also invite children to come up with positional directions of their own.

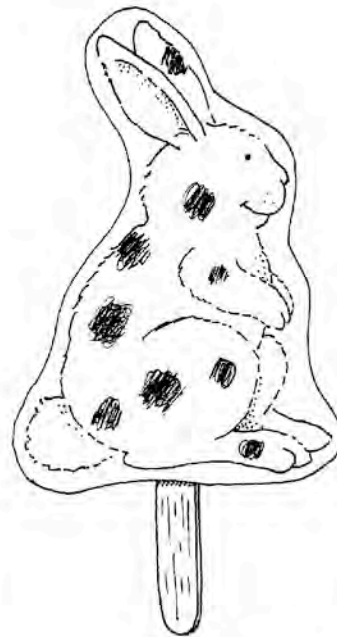

Craft

R Is for Rectangle Robot

Robots and rectangles rule this project! Use a paper cutter to cut rectangles in several sizes and from different colors of construction paper. Then give children a full sheet of construction paper and set them to work creating a rectangle robot straight from their imagination. Invite them to choose and glue different sizes and colors of the rectangle cutouts to make their robot, including details such as facial features. When finished, you might challenge children to make up alliterative sentences using the word *robot* (for example, “My red robot rode a rocket”).

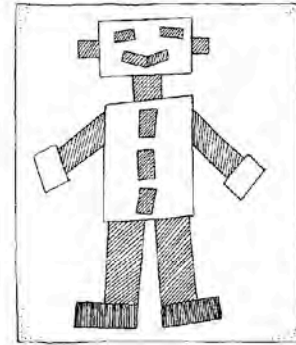

Game

R Is for Rainbow Race

Teams compete to assemble a colorful rainbow in this fun race. Make two enlarged copies of the rainbow pattern (page 113) on white tagboard. Color the bands of each rainbow in this order from top to bottom: red, orange, yellow, green, blue, and purple. Then cut apart the bands of each rainbow. To start the race, have two teams of children line up, with one child behind the other. Ask the first child on each team to name a word that begins with the letter *R*. If the child responds correctly, give him or her one band of the team’s rainbow. Then continue with the next player on each team. Once both teams get all six bands of its rainbow, signal the members to work together as fast as possible to assemble their rainbows. The first team to complete its rainbow wins!

Movement

R Is for Roll

Children will be on a roll with *R* words after they try this activity! In an open space, spread out a soft mat on which children can practice forward rolls. Once they can perform a forward roll (with a bit of assistance from you, if necessary), have children line up at one end of the mat. Then ask children one at a time to name a word that starts with the letter *R*. After they give a correct response, invite them to complete a forward roll across the mat. Keep things rolling as long as you like!

Snack R Is for Raisins

Use raisins to form a letter R as part of this oh-so-easy snack. Ask children to flatten a patty of refrigerated biscuit dough on a square of foil. Then have them use raisins to form an R on top of the biscuit. Help them sprinkle some cinnamon sugar over their biscuit, then transfer all the biscuits to a cookie sheet. Bake as directed on the package. After the raisin treats cool, serve them on napkins. Really easy and really good!



Literature R Is for Rain

Raindrops will fall in your classroom with this follow-up activity to Robert Kalan's *Rain* (Greenwillow Books, 1991). To prepare, cut a class supply of raindrop shapes from blue construction paper, as well as two cloud shapes from white paper. Label one of the clouds and some of the raindrops with an uppercase R. Label the other cloud and remaining raindrops with a lowercase r. After sharing the story, distribute the raindrops to a small group of children. Have them sort the raindrops onto the clouds labeled with the corresponding uppercase or lowercase R.

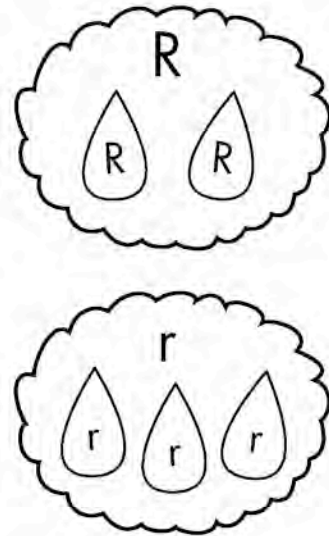

Letter Rr Mini-Book

Reinforce children's knowledge of the letter R and their letter-writing skills with this mini-book. First, duplicate a class supply of the mini-book patterns (page 114). Ask children to color the cover and pages, write their name on the cover, and trace the letters on page 5. Then have children cut apart the pages, stack them in order behind the cover, and staple the mini-book together in the upper left corner. Read the mini-book aloud as a class, emphasizing the beginning sound of R in the appropriate words. Then send the mini-books home for children to share with their family.



Rr

A B C D E F G H I J K L M

Rabbit Patterns

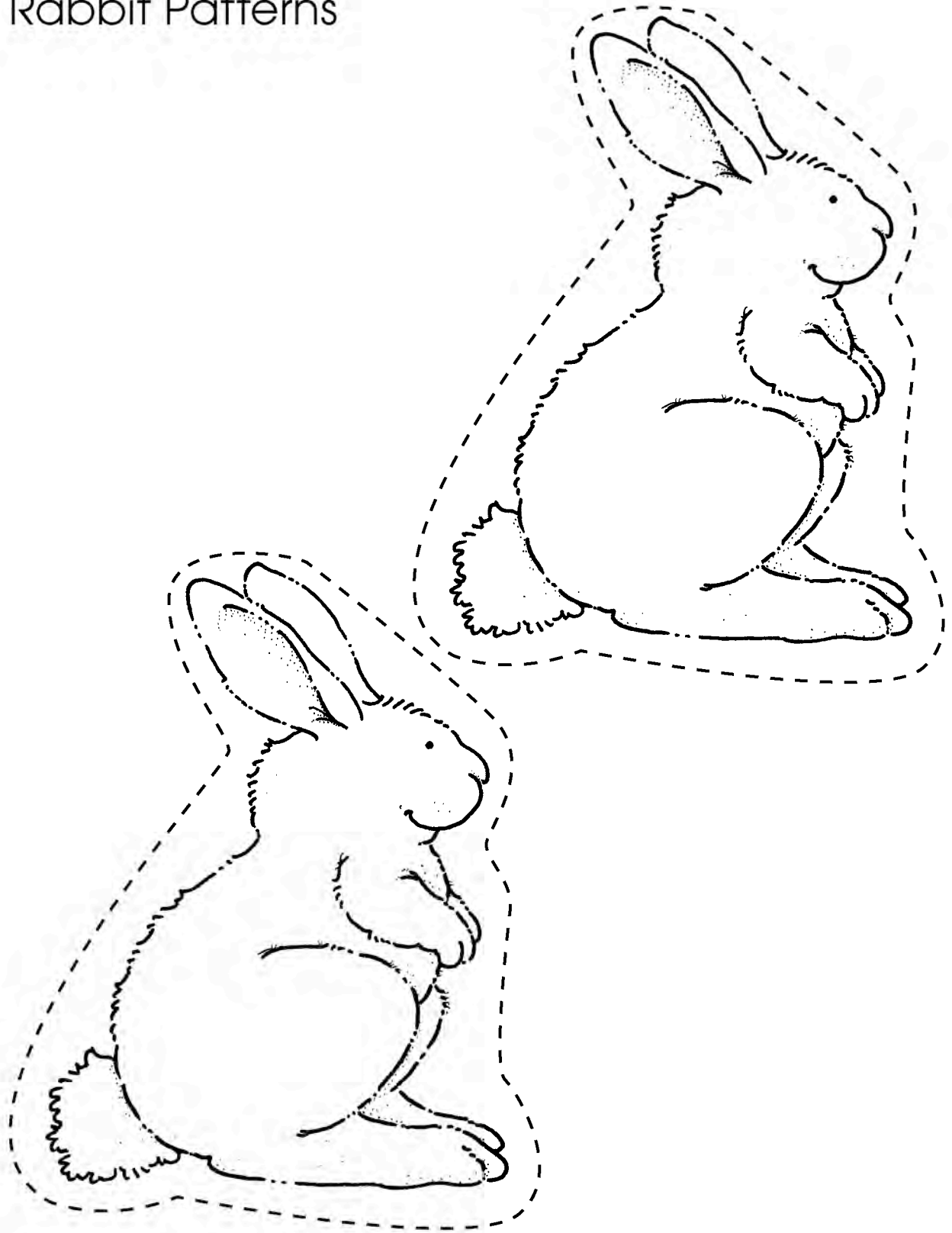

Rainbow Pattern

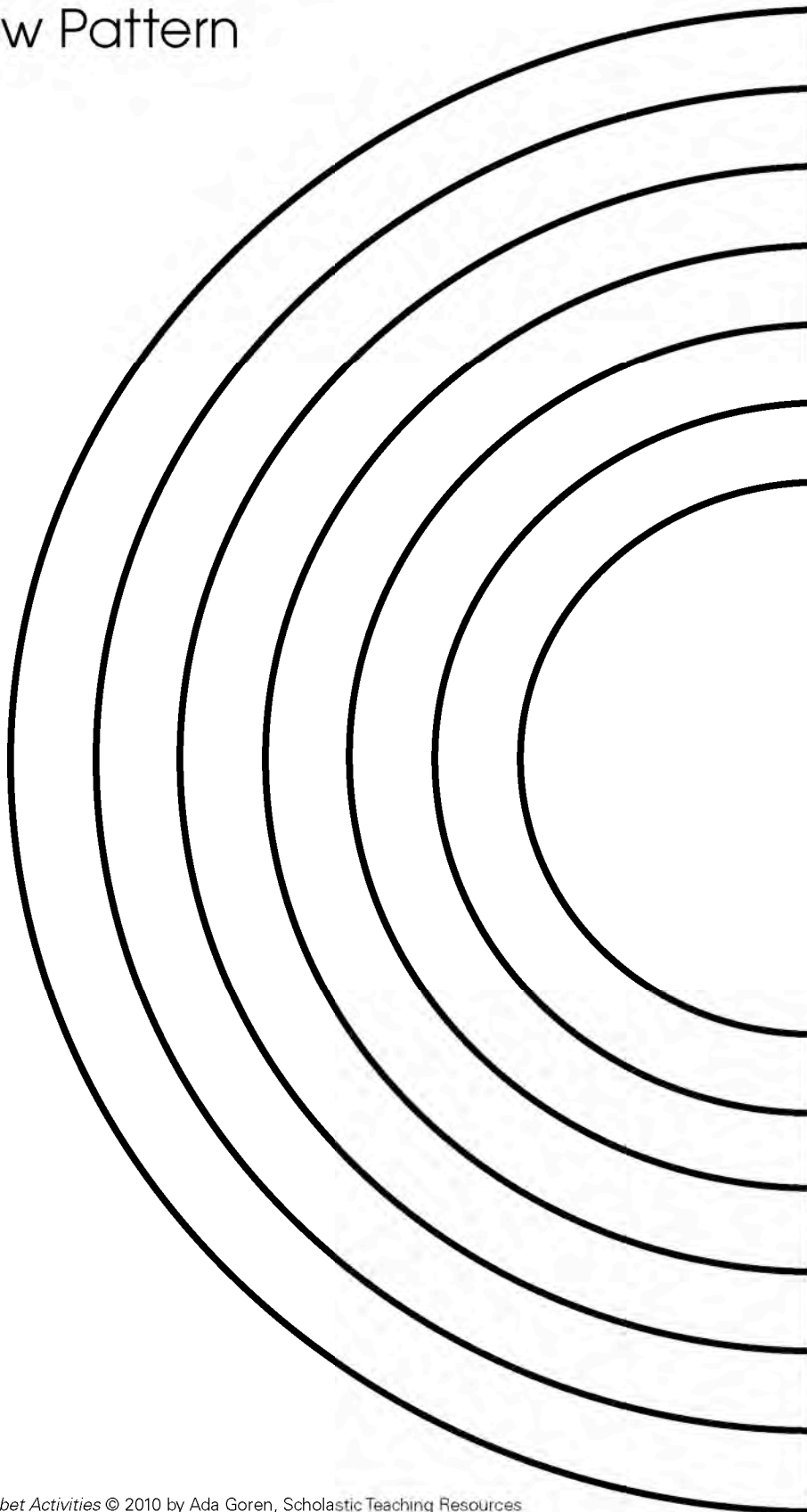

Roger Raccoon Runs by...



Name: _____



a **r**ake,

1

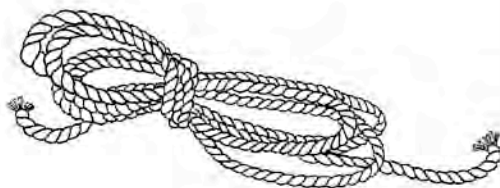

a **r**ope,

2

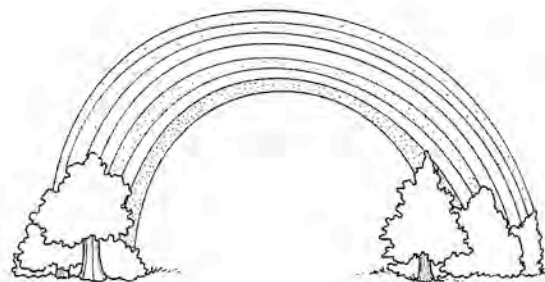

a **r**ainbow,

3



a **r**ing,

4



and the letter **Rr!**

5

Introducing Ss

Before beginning your study of the letter Ss, remove the picture cards that begin with this letter (pages 231 and 233). Cut apart and laminate the cards for durability. Then write an uppercase and lowercase S on the chalkboard, or display a large letter card. Show children each picture card. As you name the picture, emphasize its beginning sound. Then point to and name the letter S on the board. Have children repeat the word and the sound of S at the beginning of the word. After reviewing, keep the cards on display and use them throughout your letter study.

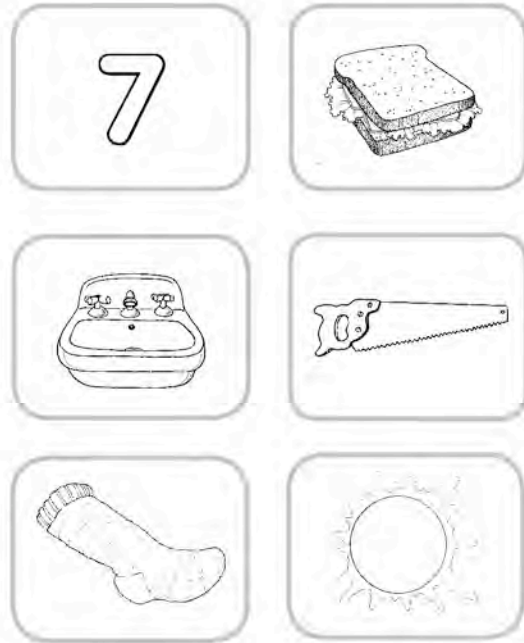

Math

S Is for Sunflower

Watch children's number skills blossom with the help of some sunflowers! Make ten copies of the sunflower mat (page 118) on yellow construction paper. Write a number from 1 to 10 in the box next to the flower on each mat. Then provide a small group of children with real sunflower seeds. First ask them to use some of their seeds to form the letter S on the tabletop. Remind them that *sunflower* and *seeds* both start with an S. Next, invite children to choose a mat, name the number in the box, and then put that number of seeds on the flower center. When finished, ask children to pass their mat to another group member to check their counting.

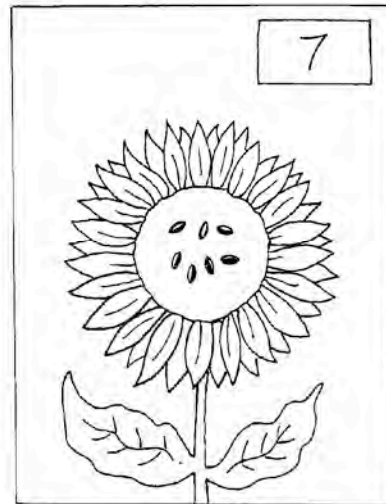

Craft

S Is for Super Sock Puppet

These whimsical sock puppets don't even require socks! Duplicate the sock and cape patterns (page 119) onto different colors of construction paper. Then invite children to choose a sock and a cape in the colors of their choice and cut out the patterns. Have them glue a wiggle eye to the sock where indicated and draw a mouth to give their sock a face. To make their sock character a super-hero, ask children to draw a large *S* on the cape and then glue the cape to the lower part of the sock. Help them tape a jumbo craft stick to the back of the sock to serve as a handle. Finally, encourage children to give their sock puppet a name that begins with *S* (such as "Super Sock"). During group time, invite children to introduce their puppet to the class.

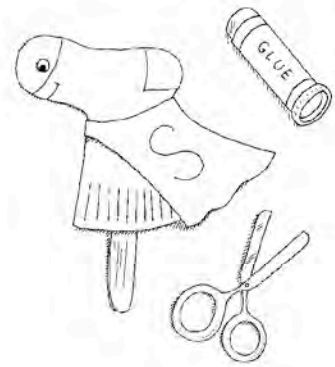

Game

S Is for Soup

This game might start off sensibly, but it will soon turn silly! Seat children in a circle and tell them that you want their help in planning a special soup, since the word *soup* begins with an *S*. Explain that they can name ingredients to go into the soup—but each one must be something that begins with the sound of *S*. Then start the activity by saying, "I'm making soup today, and I'm putting in salt." Ask the child seated next to you to repeat the sentence, replacing *salt* with a different ingredient that begins with *S*. Continue around the circle in this way until every child has had a turn. Children can put anything into the imaginary soup—a sock, sofa, saxophone, and even a snake—as long as it starts with *S*!

Movement

S Is for Sandwich

Turn children into sandwiches for this fun race! Gather a carpet square for every two children in your class. Then choose an open area for the race. Pair up children and have the partners stand back-to-back. Slide a carpet square between the two children, then have them move close together and hold hands so that the carpet square is sandwiched between them. Once each pair has been made into a "sandwich", have all the pairs stand at a starting line. On a signal, the sandwiches race to a designated finish line, trying to keep their "filling"—the carpet square—between them. If any sandwich loses its "filling," the pair must go back and start again.

Snack

S Is for Sun

This fruity treat looks like a gleaming sun and is perfect for emphasizing the letter S! First, give children a paper plate with a pineapple ring in the center. Also give them a handful of golden raisins. Tell children that the pineapple represents a round sun and that *sun* begins with an S. Then have them lay their raisins out in lines around the rim of their pineapple to create sunrays. Such a sweet, sunshiny treat!

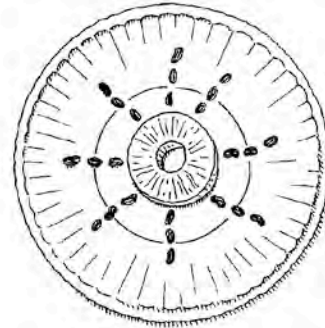

Literature

S Is for Silly Sally

Children are sure to love *Silly Sally* (Harcourt Children's Books, 1999) by Audrey Wood when you share this humorous story. After their giggles subside, do this activity to help children practice recognition of the beginning sound of S. Say aloud a list of words, in which most begin with the letter S, and a few begin with other letters. Explain that if children hear a word beginning with an S, they should do something silly, such as making a crazy face or dancing a funny jig. If the word begins with a letter other than S, children should remain still and act serious.

- Some words that begin with S:**
- sofa
 - sale
 - seek
 - sorry
 - sauce
 - south
 - summer
 - seal

Letter Ss Mini-Book

Reinforce children's knowledge of the letter S and their letter-writing skills with this mini-book. First, duplicate a class supply of the mini-book patterns (page 120). Ask children to color the cover and pages, write their name on the cover, and trace the letters on page 5. Then have children cut apart the pages, stack them in order behind the cover, and staple the mini-book together in the upper left corner. Read the mini-book aloud as a class, emphasizing the beginning sound of S in the appropriate words. Then send the mini-books home for children to share with their family.

Ss

A B C D E F G H I J K L M

Sunflower Mat

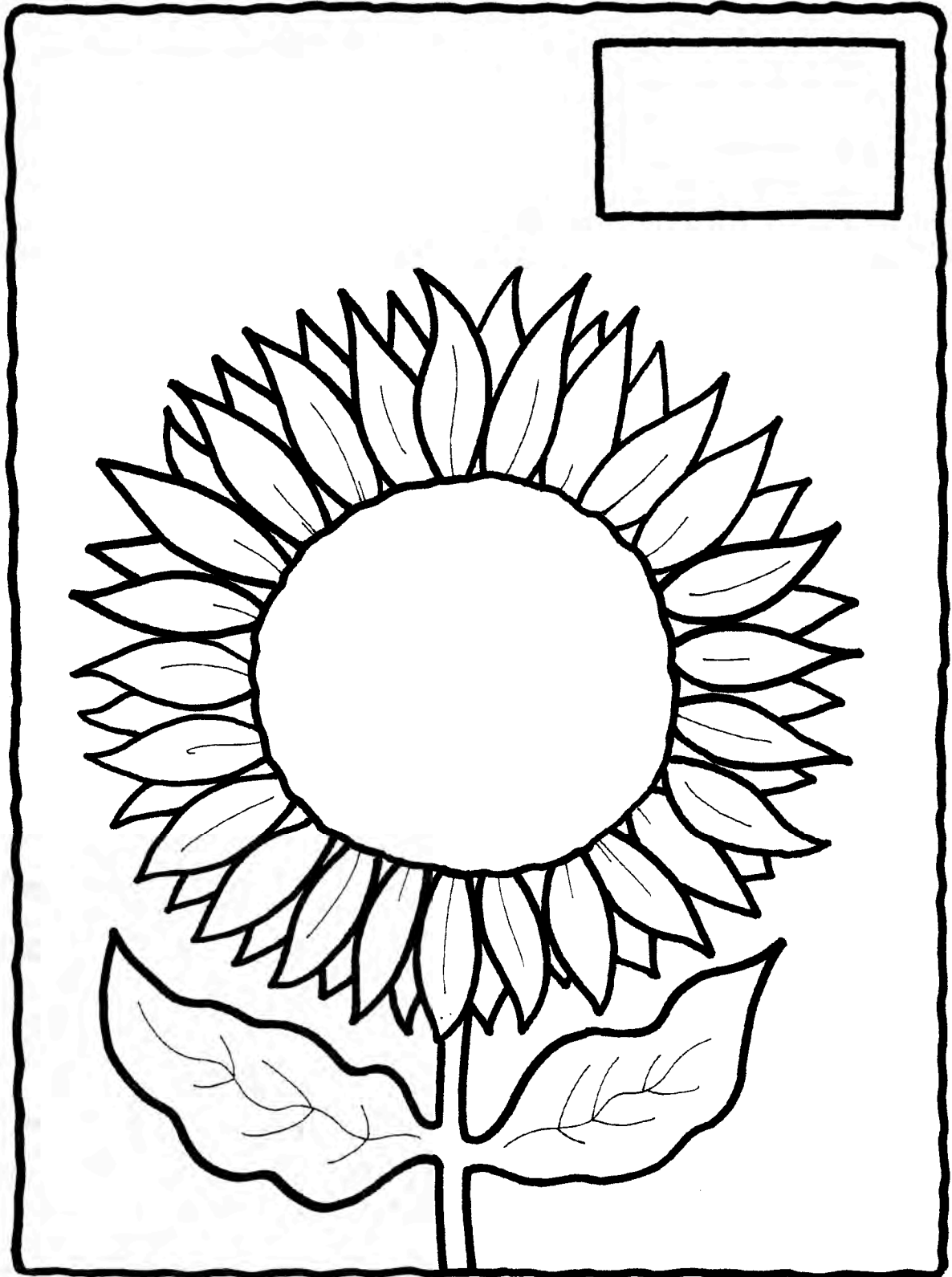

Sock and Cape Patterns

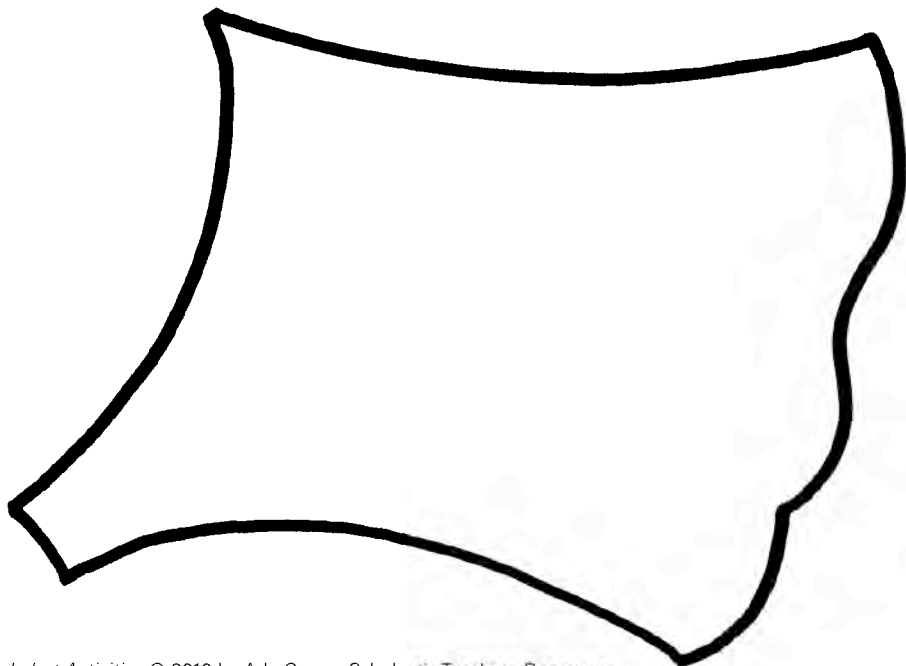
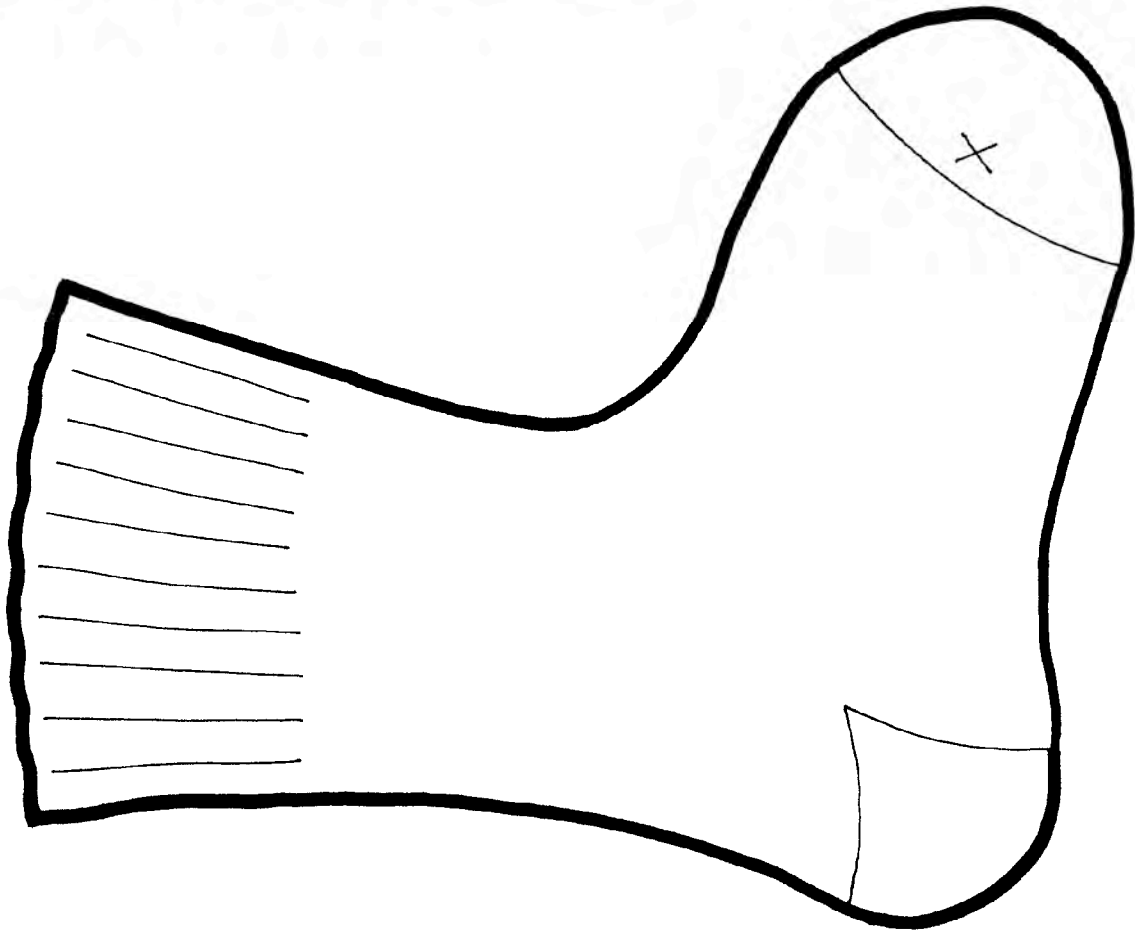

Suki Sunflower Sees...

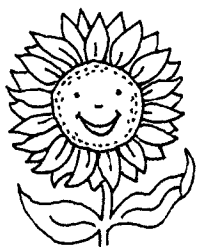

Name: _____



a **s**ock,

1

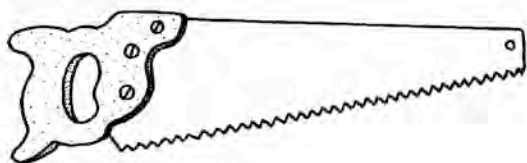

a **s**aw,

2

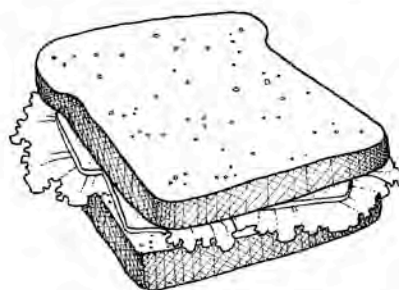

a **s**andwich,

3



scissors,

4



and the letter **Ss**!

5

Introducing Tt

Before beginning your study of the letter *Tt*, remove the picture cards that begin with this letter (pages 233 and 235). Cut apart and laminate the cards for durability. Then write an uppercase and lowercase *T* on the chalkboard, or display a large letter card. Show children each picture card. As you name the picture, emphasize its beginning sound. Then point to and name the letter *T* on the board. Have children repeat the word and the sound of *T* at the beginning of the word. After reviewing, keep the cards on display and use them throughout your letter study.



Math

T Is for Teddies in Tents

Team up teddy bears and tents to provide practice with matching numbers and sets. To prepare, make five copies of the tent mats (page 124) on colorful construction paper. Cut out the tents, write a number from 1 to 10 on each one, and laminate all of the mats for durability. Then provide each child in a small group with a supply of plastic teddy bear counters. To use, ask children to line up some of their bears to form a letter *T*. Point out that both *teddy* and *tent* begin with the sound of *T*. Then have children choose a tent mat, name the number on it, and place a corresponding set of teddy bear counters on the tent. Ask children to switch their mat with a classmate to check each other's work. Then have them clear off their mat, choose a different mat, and repeat the activity.

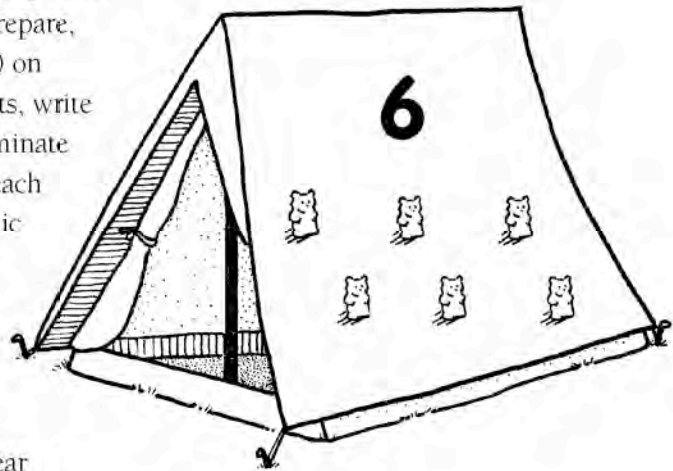

Craft

T Is for Turtle

Children will think this cute turtle is tops! To prepare, duplicate a class supply of the turtle patterns (on page 125) onto green construction paper. Then cut a large supply of tissue paper squares in various shades of green and brown. For each child, tape an oval sheet of clear Con-Tact® vinyl covering sticky-side-up on a table (remove the backing). Ask children to cut out their turtle patterns and stick them to the vinyl, as shown, to create a turtle. Then have them stick on squares of green and brown tissue paper to decorate the turtle shell. When finished, help children carefully press a second vinyl oval of the same size on top of the turtle shell. Finally, invite them to add facial features and other details to complete their turtle.

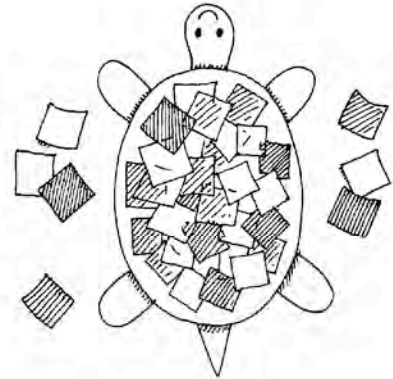

Game

T Is for Turkey's Tail Feathers

To prepare this small group game that lets children practice the beginning sound of *T*, duplicate the turkey game boards (pages 126 and 127) onto tagboard. Color and cut apart the game boards, then laminate them for durability. To play the game, invite each child in the group to take a game board and a handful of round plastic game markers. (Or cut out and laminate brown tagboard circles to serve as game markers.) Then call out the name of one of the pictures on a game board. (All of the picture names begin with a *T*.) If children have that picture on their turkey, they cover it with a marker. The first child to cover all the pictures on his or her game board calls out, "Turkey's Tail Feathers!" and wins the game.

Movement

T Is for Tape Tightrope

Use masking tape to create a long line on the floor in an open area. Then, for this movement activity, have children take turns naming a word that begins with the sound of *T*. When they give a correct response, invite them to walk heel-to-toe along the line, as if they were walking a tightrope at the circus. After every child has had a turn to walk the tightrope, repeat the activity, challenging children to try to come up with *T* words before they cross the tightrope—this time on tiptoe!

Snack

T Is for Tortilla Chips and Taco Dip

Watch as children go to town on this tasty treat! Invite children to help mix together ¼ cup mayonnaise, ½ cup sour cream, and 2 teaspoons taco seasoning in a bowl. Then give them a dollop of the dip on a paper plate, along with a handful of tortilla chips. As children eat their tasty snack, point out that *taco* and *tortilla* start with letter *T*. Can they think of other foods that begin with *T*?

Literature

T Is for Little Rabbit's Loose Tooth

Children may or may not have lost any teeth yet, but they'll love sharing *Little Rabbit's Loose Tooth* (Crown Books for Young Readers, 2006) by Lucy Bate. Before reading the book with children, copy a class supply of the tooth cards (page 125) on white construction paper. Label each tooth with an uppercase or lowercase *T*. Then hide the cards around your classroom. After reading the book, give children practice in recognizing the uppercase and lowercase forms of the letter *T*. To begin, ask children to pretend they are a tooth fairy. Then send them on a search to find the "lost" teeth around the room. After they have found as many teeth as possible within a designated amount of time, have children sort the teeth into two groups—uppercase and lowercase versions of *T*.

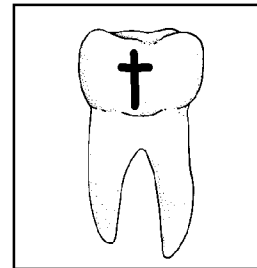
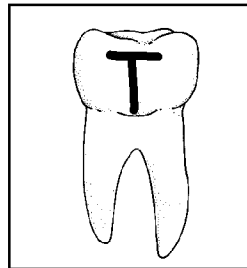

Letter Tt Mini-Book

Reinforce children's knowledge of the letter *T* and their letter-writing skills with this mini-book. First, duplicate a class supply of the mini-book patterns (page 128). Ask children to color the cover and pages, write their name on the cover, and trace the letters on page 5. Then have children cut apart the pages, stack them in order behind the cover, and staple the mini-book together in the upper left corner. Read the mini-book aloud as a class, emphasizing the beginning sound of *T* in the appropriate words. Then send the mini-books home for children to share with their family.

Tt

A B C D E F G H I J K L M

Tent Mats

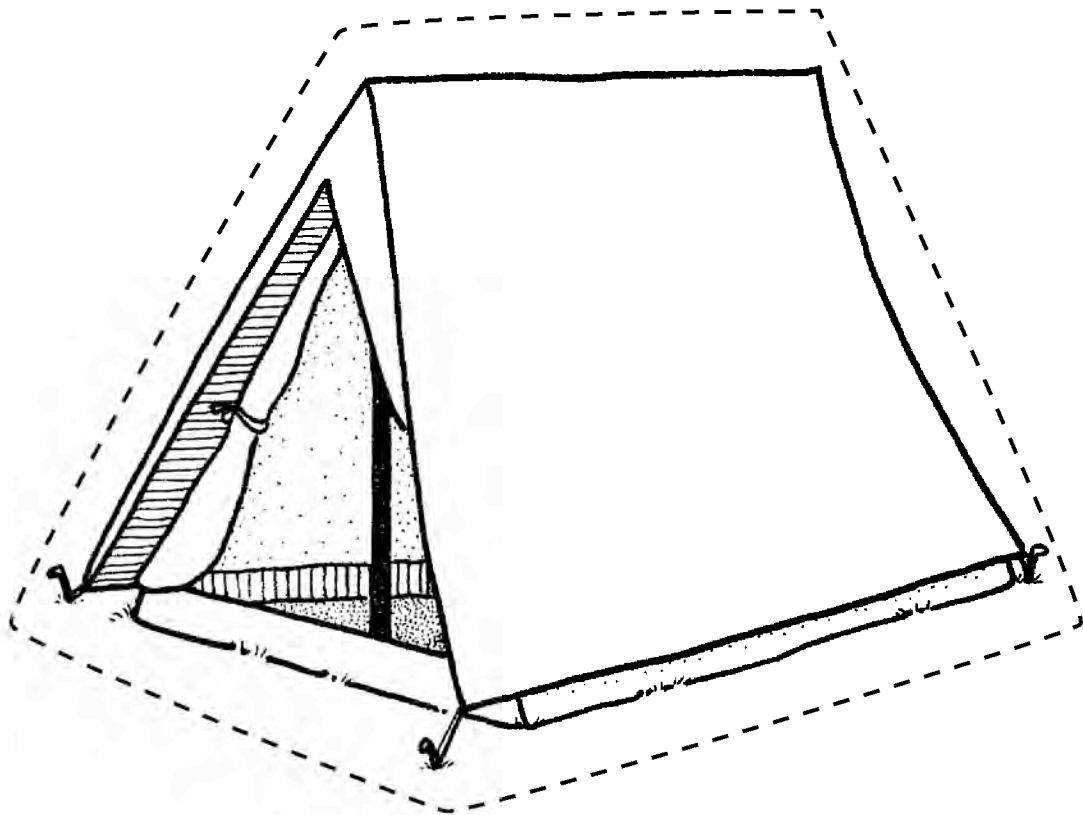
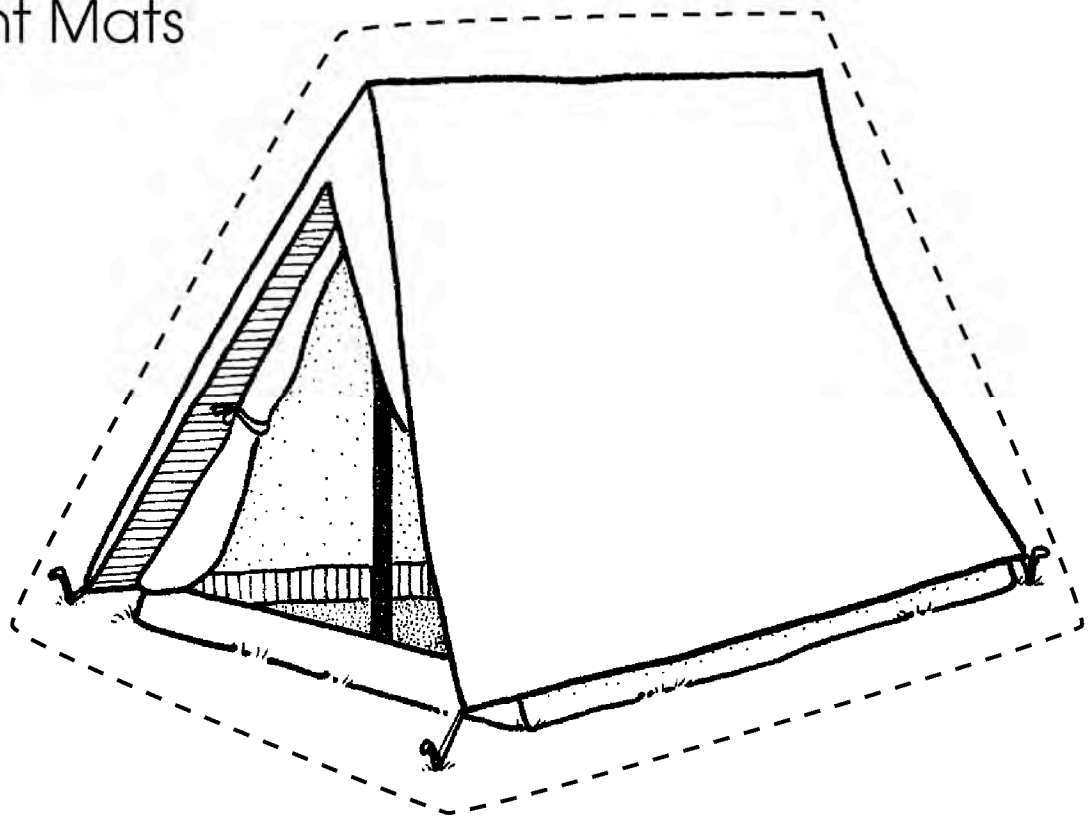

Turtle Patterns

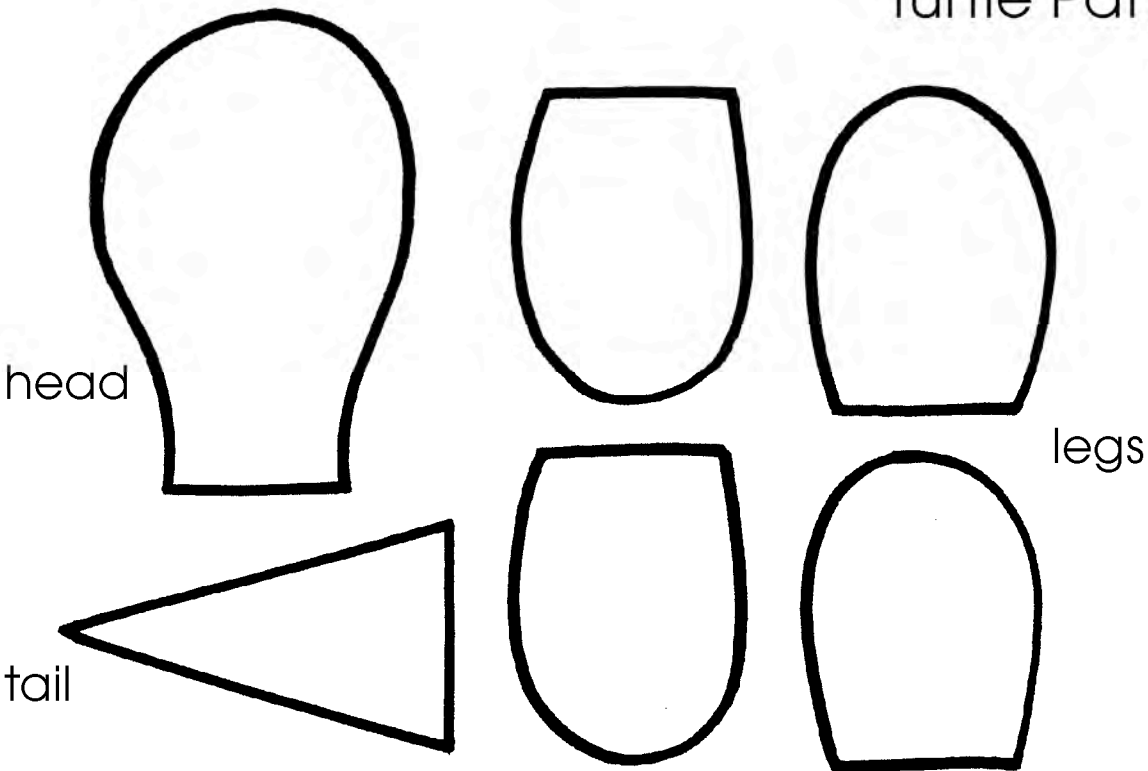

Tooth Cards

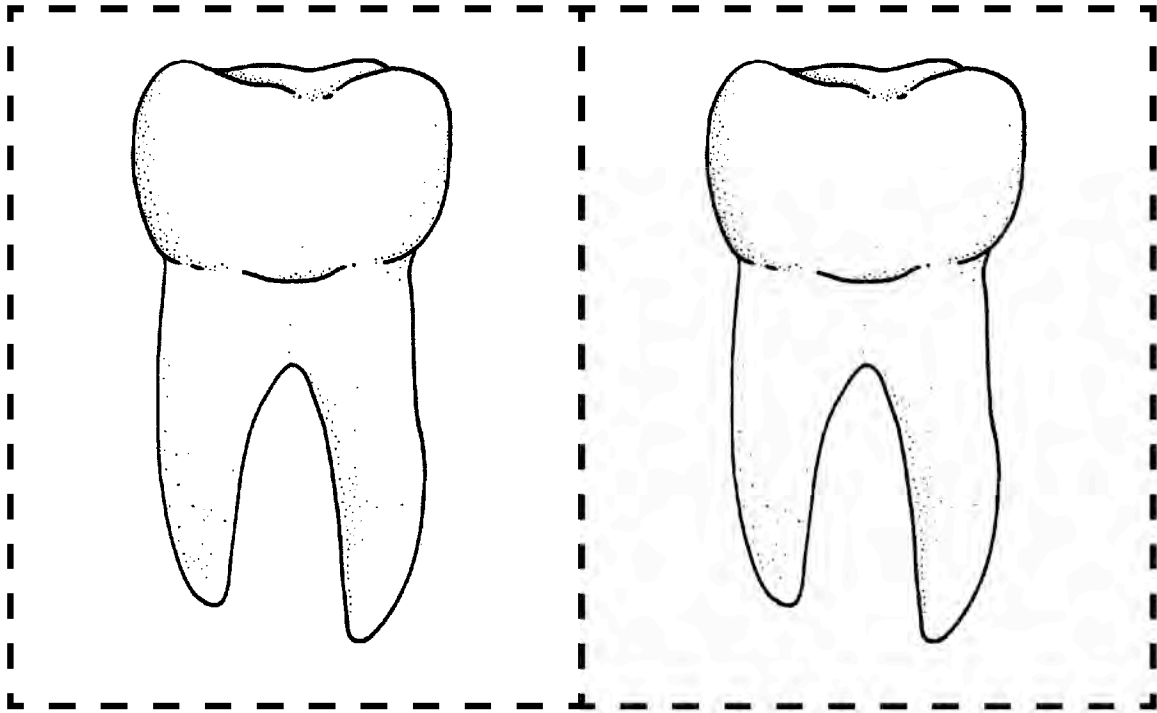

Tt

A B C D E F G H I J K L M

Turkey Game Boards

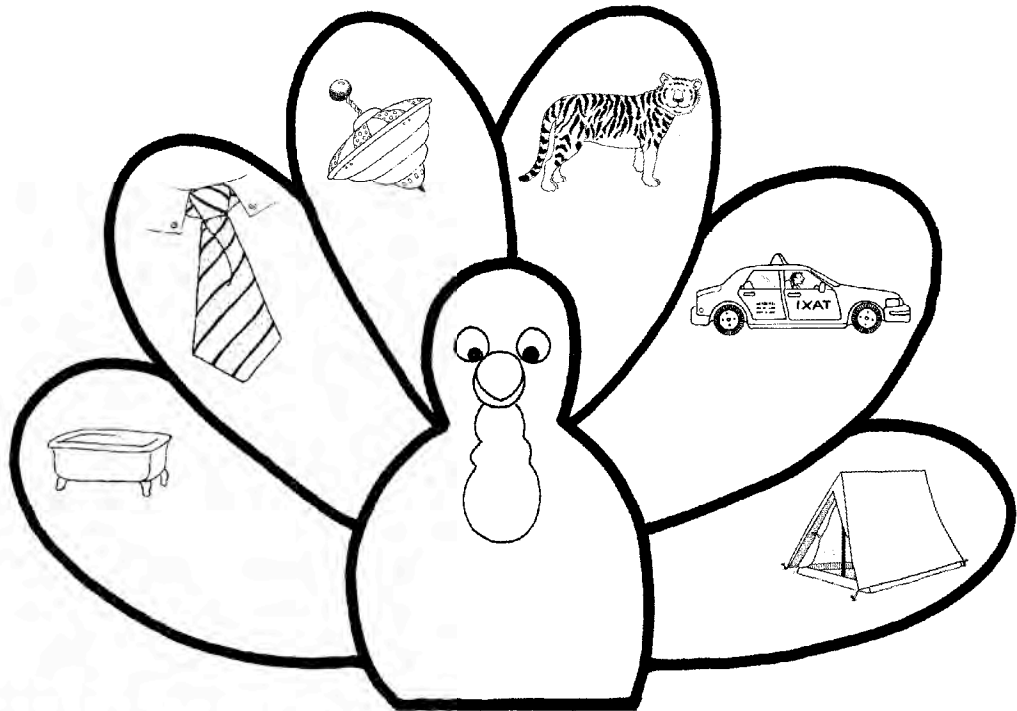
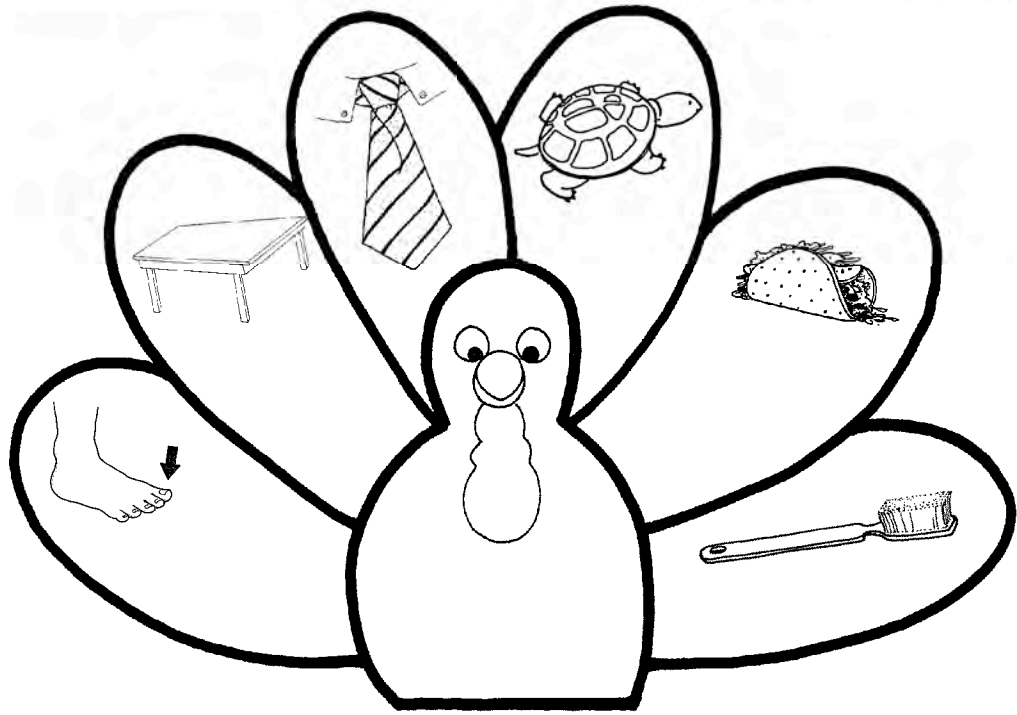

Turkey Game Boards

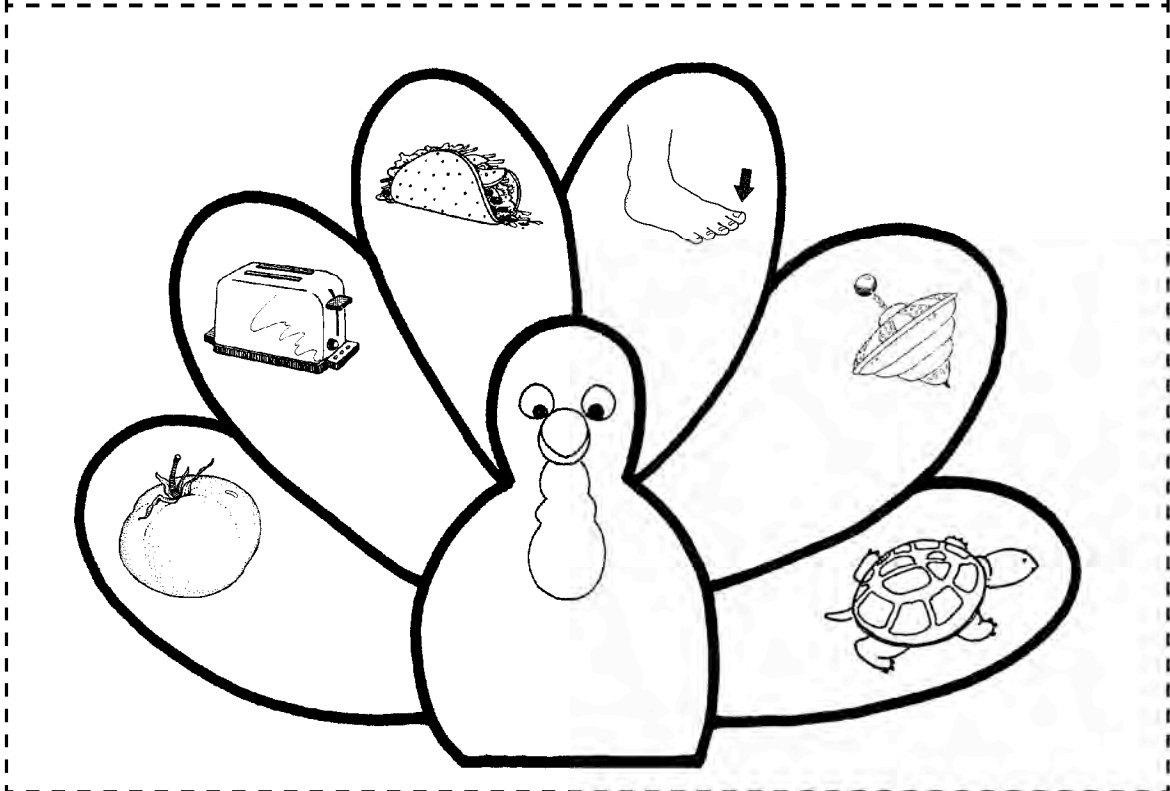
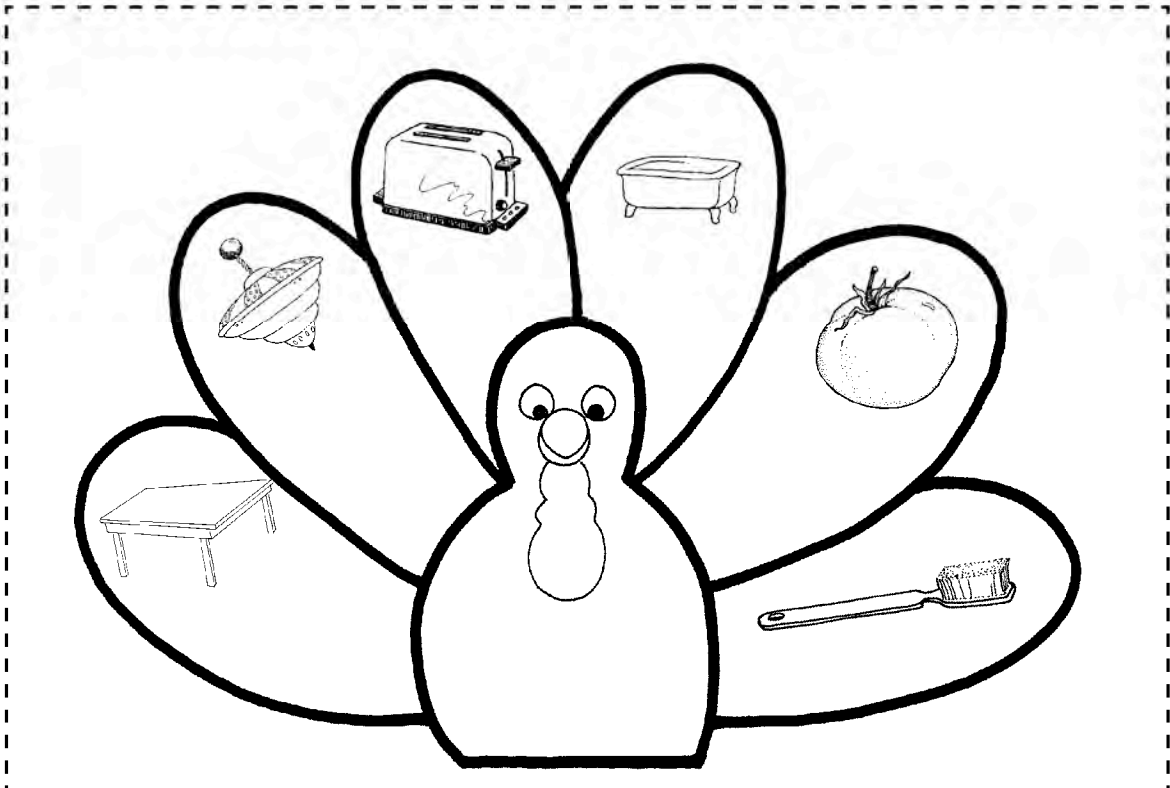

Tab Tiger Has...



Name: _____



a **t**oothbrush,

1

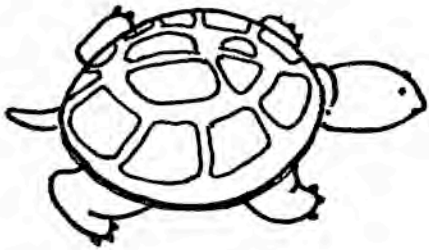

a **t**urtle,

2

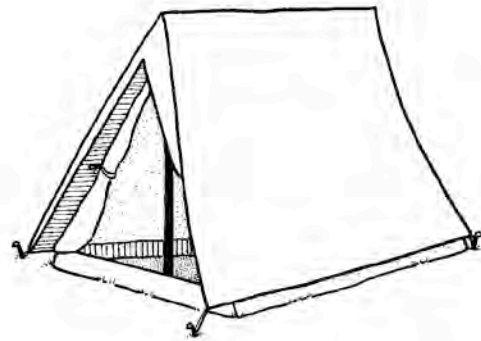

a **t**ent,

3

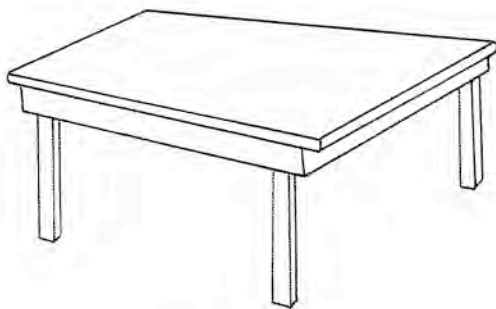

a **t**able,

4



and the letter **Tt!**

5

Introducing Uu

Before beginning your study of the letter *Uu*, remove the picture cards that begin with this letter (pages 237 and 239). Cut apart and laminate the cards for durability. Then write an uppercase and lowercase *U* on the chalkboard, or display a large letter card. Show children each picture card. As you name the picture, emphasize its beginning sound. Then point to and name the letter *U* on the board. Have children repeat the word and the sound of *U* at the beginning of the word. After reviewing, keep the cards on display and use them throughout your letter study.

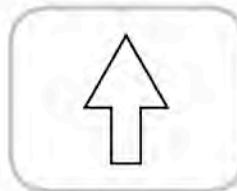

Math

U Is for Umbrella

Bring in an umbrella from home for this math lesson focused on ordinal numbers. Ask five children to line up next to one another in front of the group. Carefully open the umbrella and have the first child stand under it. Point out that both *under* and *umbrella* start with the short sound of *U*. Then point out that the *first* child is under the umbrella. Have that child pass the umbrella to the next child. Tell children that now the *second* child is under the umbrella. Have children continue passing the umbrella down the line, naming the ordinal number that corresponds to each child standing under the umbrella (from *first* through *fifth*). To extend, have five more children take turns crawling under a table (Explain that *under* begins with *U*.) Ask the class to watch and name the ordinal position of each child as he or she goes under the table.



Craft

U Is for Underwater

What do children think they'd see under the sea? Find out when they make these underwater scenes. For each child, cut scallops along one long edge of a 12- by 18-inch sheet of white construction paper to make a wavy water line. Then invite children to draw sand, plants, and sea creatures on their papers to create an underwater scene.

Encourage them to use bright colors and to color firmly. When they finish, give children a slightly larger piece of blue cellophane to glue over their drawing. Tell them to glue only along the edges of their scene. Once the glue dries, help children trim away the excess cellophane. Display the completed projects with the title, "U Is for Underwater!"

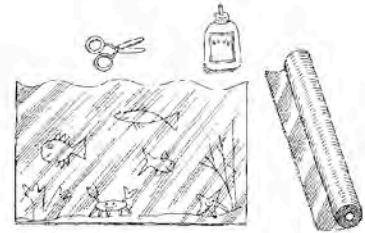

Game

U Is for Uh-Oh!

To provide practice with recognizing the letter *U*, play a pocket-chart game of "Uh-Oh!" Label several plain index cards with an uppercase or lowercase *U*. Label two additional cards with other letters. Then put the cards facedown in random order in one row of a pocket chart. Playing with a small group, invite one child at a time to flip over the cards, from left to right. As children reveal the printed side of each card, have them name the type of letter on it, for example, "uppercase *U*" or "lowercase *u*."

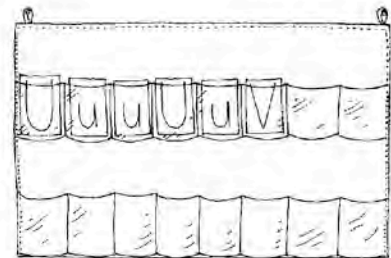

Movement

U Is for Upside-Down

Turn things topsy-turvy today by helping children walk upside down! First use masking tape to create a large letter *U* on the floor in an open area. Explain to children that they will "walk" along the tape *U*—only they'll walk upside down on their hands while you hold their ankles to help steady them. Then invite children to take turns walking the *U*. (As an alternative, let children bear-walk along the letter, hanging their head upside down as they go.) Utterly fun!

Snack

U Is for Undersea

Combine art and edibles to make this tasty undersea snack. First, ask children to draw a blue, wavy water line across the top of a sheet of copy paper. Then have them color the area below the line blue to represent the sea. Next, give children some colorful fish-shaped crackers and several pretzel sticks. Ask them to arrange the pretzel sticks near the bottom of their undersea scene to form seaweed. Finally, have them scatter their fish crackers throughout the scene. As children admire each other's edible pictures, remind them that *undersea* begins with the letter *U*. Then invite them to eat up!

Literature

U Is for Underwear!

With the book *Underwear!* (Albert Whitman & Company, 1993) by Mary Elise Monsell, the title alone will set children to giggling! After hearing this silly story about animals wearing boxer shorts, they'll be ready to make some designer undies of their own with this activity. First, give children a white construction-paper copy of the underwear pattern on page 132. Invite them to color the underwear, adding a pattern or other design as they wish. Then have them cut out their pattern and bring it to group time. For the activity, say aloud a list of words, some of which begin with the short sound of *U*, and some that begin with other letter sounds. Ask children to turn their underwear cutout upside-down each time they hear a word that begins with the short *U* sound. If they hear a word that begins with another sound, they should keep the cutout turned right side up.

Some words that begin with U:

- uncle
- umbrella
- up
- under
- us
- underground
- umpire
- ugly

Letter Uu Mini-Book

Reinforce children's knowledge of the letter *U* and their letter-writing skills with this mini-book. First, duplicate a class supply of the mini-book patterns (page 133). Ask children to color the cover and pages, write their name on the cover, and trace the letters on page 5. Then have children cut apart the pages, stack them in order behind the cover, and staple the mini-book together in the upper left corner. Read the mini-book aloud as a class, emphasizing the beginning sound of *U* in the appropriate words. Then send the mini-books home for children to share with their family.

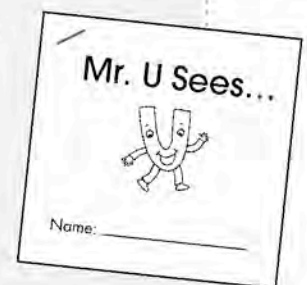

Uu

A B C D E F G H I J K L M

Underwear Pattern

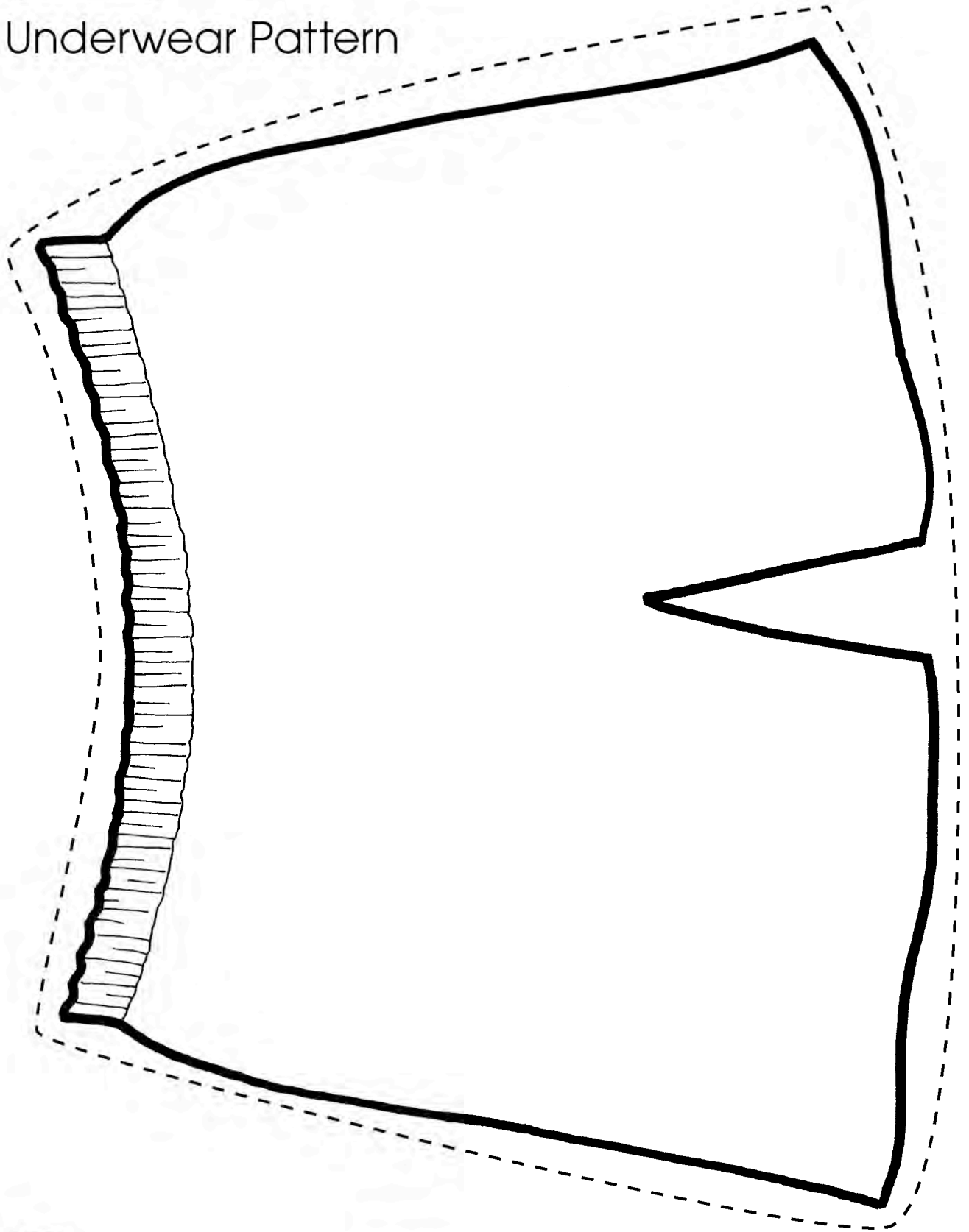

Mr. U Sees...

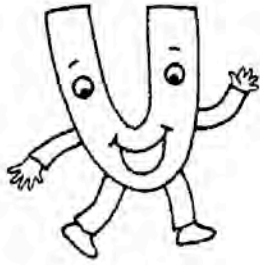

Name: _____



an **u**mbrella,

1



an **u**mpire,

2

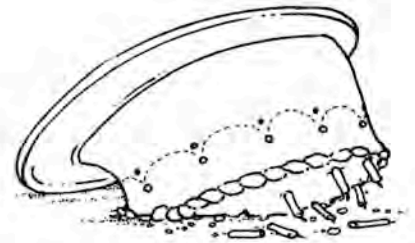

an **u**pside-down cake,

3



underwear,

4



and the letter **Uu!**

5

Introducing Vv

Before beginning your study of the letter Vv, remove the picture cards that begin with this letter (pages 239 and 241). Cut apart and laminate the cards for durability. Then write an uppercase and lowercase V on the chalkboard, or display a large letter card. Show children each picture card. As you name the picture, emphasize its beginning sound. Then point to and name the letter V on the board. Have children repeat the word and the sound of V at the beginning of the word. After reviewing, keep the cards on display and use them throughout your letter study.



Math

V Is for Van

Ask a small group of children to drive on over for a lesson in ordinal numbers. Duplicate the van patterns (page 137) on five different colors of paper. Make enough for each child in the group to have one van in each color. Cut out the vans and give one of each color to each child. Before beginning the activity, ask children to arrange their five vans in the shape of a letter V. Then tell them to follow the directions you give to line up their vans in a specific order. For example, you might say, "Put your red van *first*. Put your green van *second*." Once children have lined up their vans, have them take turns counting their vans using ordinal numbers (*first*, *second*, and so on). For further practice, repeat the activity and invite children to give the directions for lining up the vans.



Craft

V Is for Volcano

Invite children to the art center to create these very cool volcanoes! First, ask them to use their fingers to spread brown tempera paint on a cookie sheet or large piece of foil. Then help them press a sheet of white construction paper onto the wet paint to transfer it onto the paper. After the paint dries, have children cut out a large volcano shape from the paper. Remind them that *volcano* begins with a *V*. Then, to make a background for their volcano, ask children to tear a strip from a long edge of a sheet of green construction paper. Have them glue the strip along one long edge of a sheet of blue construction paper, as shown, creating grass and sky. Then have children glue their volcano onto the background. For a finishing touch, invite them to glue red crinkle strips to the top of their volcanoes to resemble exploding lava.

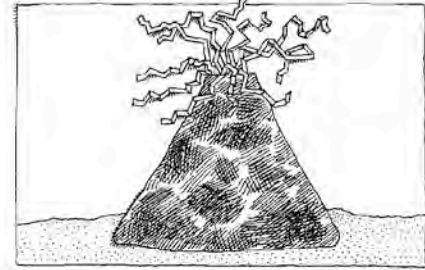

Game

V Is for Violets

Children will name words that begin with the sound of *V* in this pocket chart game. To prepare, duplicate the violet patterns (page 137) on light purple construction paper to make twelve violets. Cut out the patterns and laminate them for durability. Display the violets in rows in a pocket chart. Then hide a small letter *V* cutout behind one of the violets. Point out that the kind of flower in the chart is a *violet* and that word begins with a *V*. To play, children take turns naming a word that begins with the sound of *V*. Then they remove a violet from the chart to see if the *V* is hidden behind it. If a child finds the *V*, he or she wins that round!

Movement

V Is for Vote

Have children exercise their right to vote as they exercise their bodies! First, tell children that *vote* begins with the sound of the letter *V*. Then give them two choices for an exercise or action to perform, such as toe touches or jumping jacks. Explain that the choice that receives the most votes will be the exercise they'll do. Then take a vote, count the results, and have children do the exercise that got the most votes. After performing that exercise, have children vote on two other exercises. Repeat as often as desired to give children a vibrant and vigorous workout!

Snack

V Is for Vegetable Soup

This snack is easy to prepare and fun to eat! Heat up some vegetable soup that has alphabet pasta in it. Let the soup cool before serving it to children in small bowls. Tell children that, in addition to vegetables being healthy for them, *vegetables* also starts with the letter V. Then, as they enjoy their soup, ask children to look carefully at the letters in it to see if they can spot a V.

Literature

V Is for *The Night Before Summer Vacation*

The family in Natasha Wing's story *The Night Before Summer Vacation* (Grosset & Dunlap, 2002) is trying hard to pack up and get ready for a trip. After reading the story, ask children to do some packing of their own. Duplicate the suitcase pattern and picture cards (pages 138 and 139) onto white construction paper. Color the suitcase and pictures, cut them out, and laminate all the cutouts for durability. To start, remind children that *vacation* begins with the letter V. Then explain that the class will pack for a pretend vacation, but children will only pack things that begin with a V! Next show children one picture card at a time. Ask a volunteer to name the picture and tell if it starts with a V. If so, have the child "pack" the card into the suitcase. If not, set the card aside. Continue in this way, emphasizing the beginning sound of V at each opportunity, until all the V items have been packed.

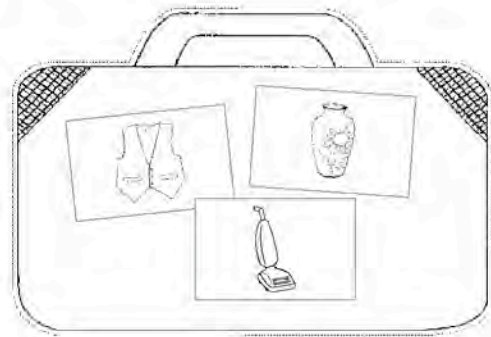
**Letter Vv Mini-Book**

Reinforce children's knowledge of the letter V and their letter-writing skills with this mini-book. First, duplicate a class supply of the mini-book patterns (page 140). Ask children to color the cover and pages, write their name on the cover, and trace the letters on page 5. Then have children cut apart the pages, stack them in order behind the cover, and staple the mini-book together in the upper left corner. Read the mini-book aloud as a class, emphasizing the beginning sound of V in the appropriate words. Then send the mini-books home for children to share with their family.

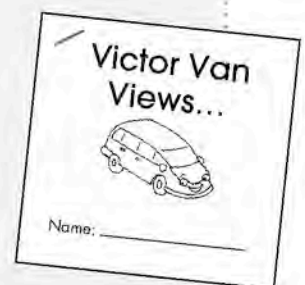

Van Patterns

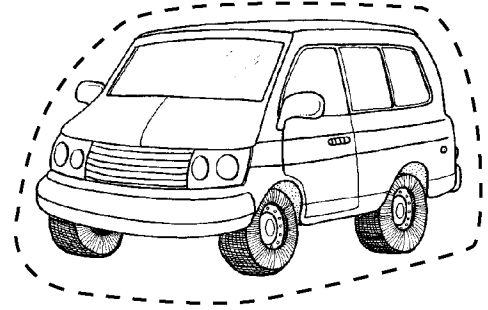
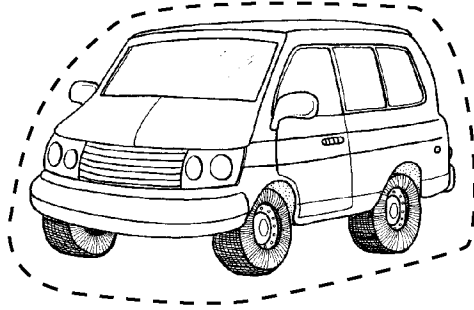
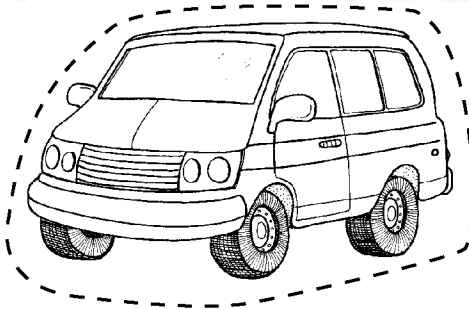
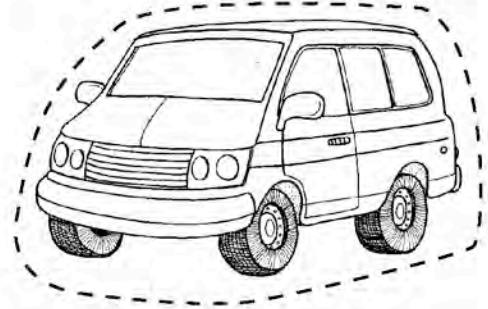
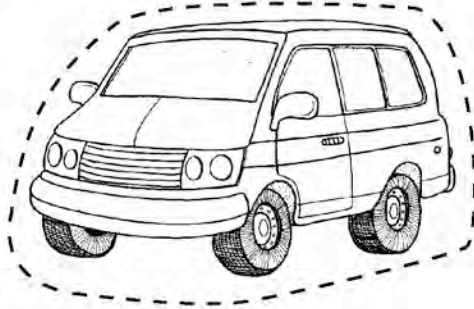

Violet Patterns

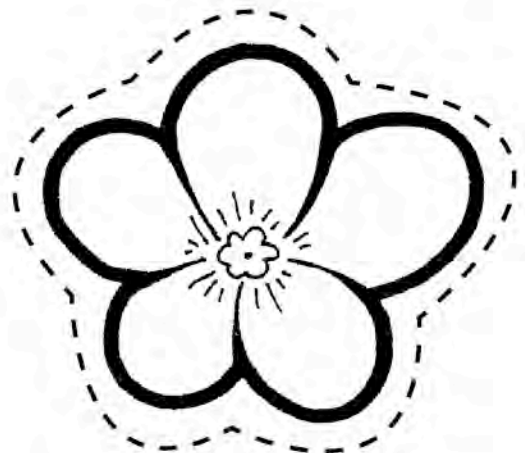
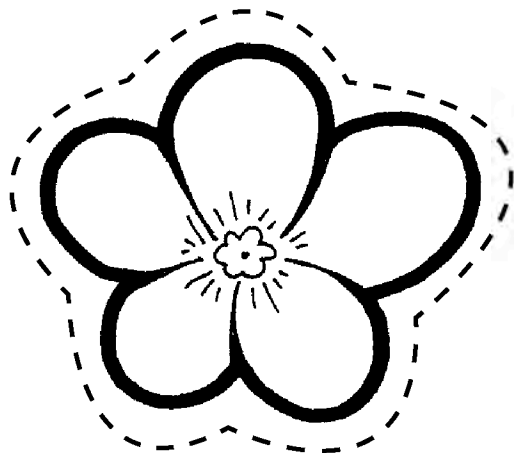

Vv

A B C D E F G H I J K L M

Suitcase Pattern

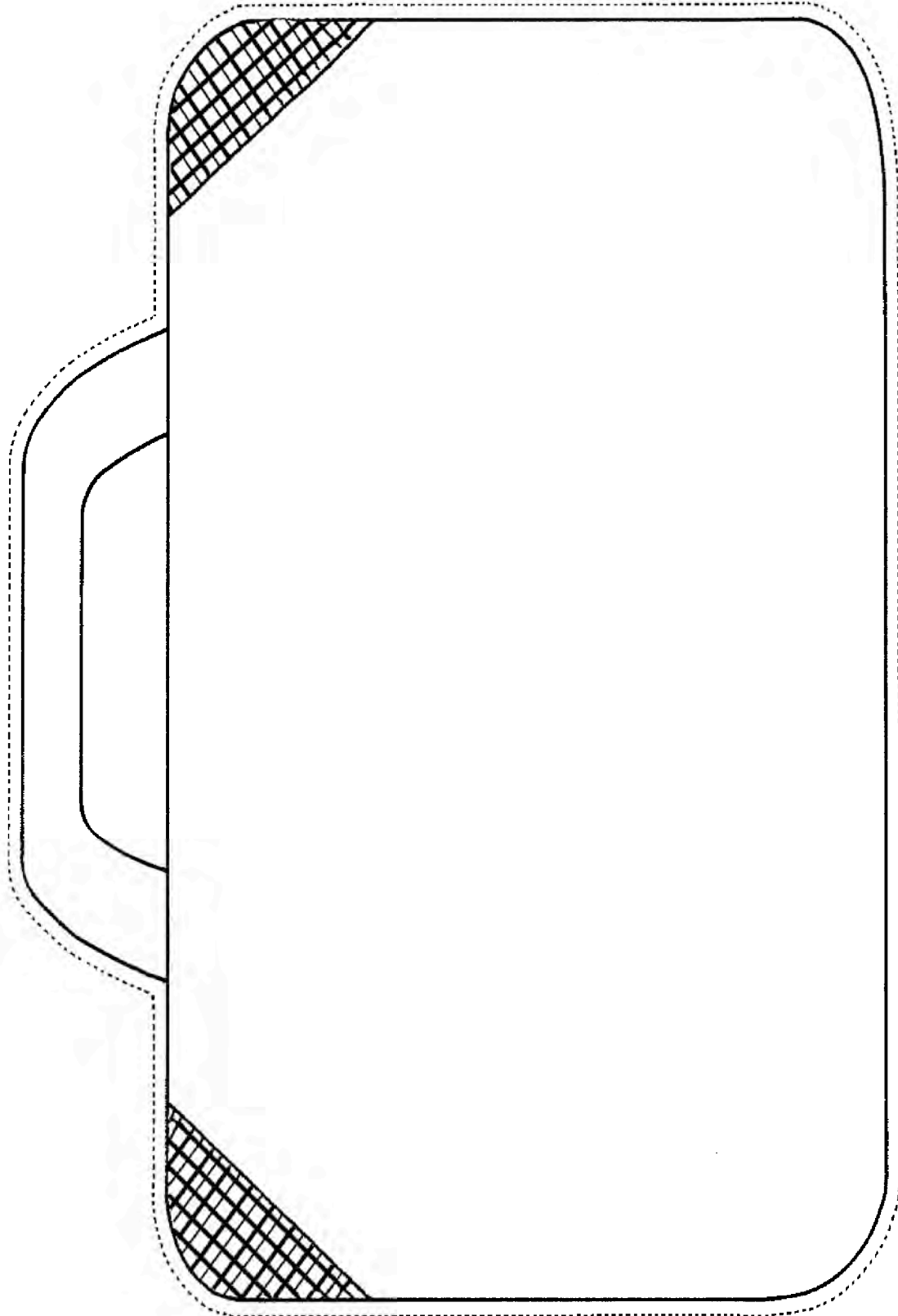

Letter V Picture Cards

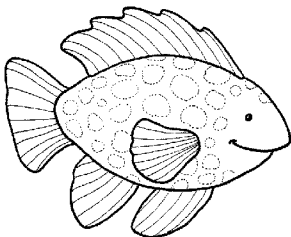
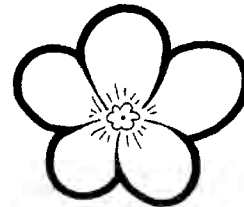
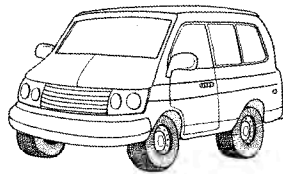
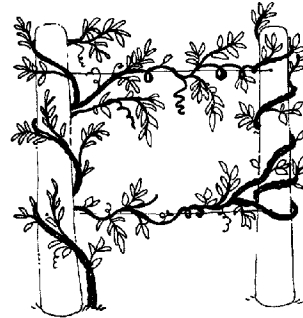
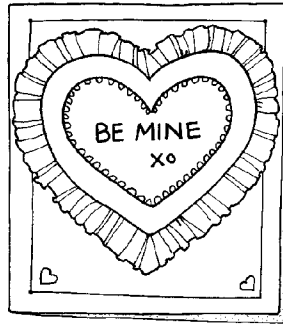
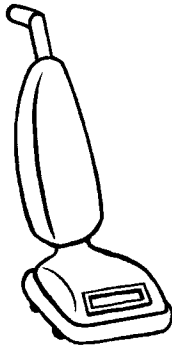

Victor Van Views...

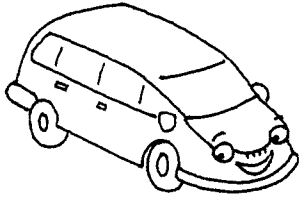

Name: _____



a **v**olcano,

1



a **v**iolin,

2

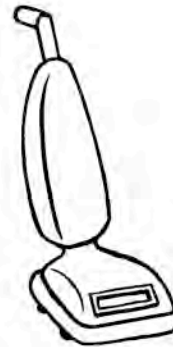

a **v**acuum,

3



a **v**est,

4



and the letter **Vv**!

5

Introducing Ww

Before beginning your study of the letter Ww, remove the picture cards that begin with this letter (pages 243 and 245). Cut apart and laminate the cards for durability. Then write an uppercase and lowercase W on the chalkboard, or display a large letter card. Show children each picture card. As you name the picture, emphasize its beginning sound. Then point to and name the letter W on the board. Have children repeat the word and the sound of W at the beginning of the word. After reviewing, keep the cards on display and use them throughout your letter study.

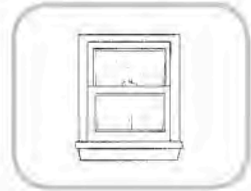
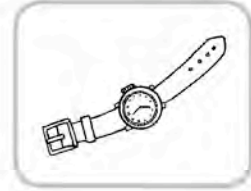

Math

W Is for Watch

Children practice number-writing skills with these giant watches. For each child, duplicate the watch face pattern (page 144) onto white construction paper. Then, working with one small group at a time, give children a watch face and point out the circles around the rim. Tell them that they will be making a watch, reminding them that *watch* begins with the letter W. Then explain that a number from 1 through 12 goes in each of the circles. Show children where to write 1 and then have them fill in the remaining numbers in sequence, working clockwise around the watch face. Once children have finished, invite them to draw hour and minute hands on the face, pointing them to any number they wish. Then have children cut out their watch face and glue it to the center of a 4½- by 18-inch strip of colored construction paper (decorated as they wish) to serve as the watchband. Wow—those are some big watches!

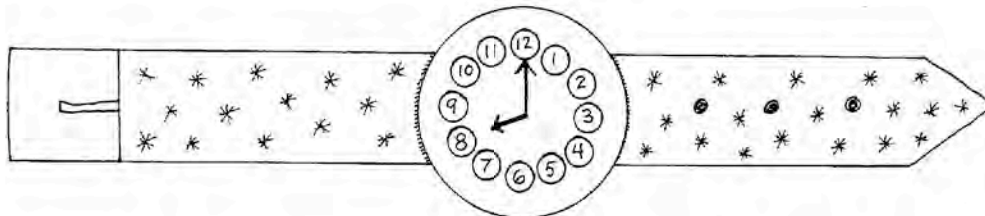

Craft

W Is for Whale

These whales are cute, and the spouts are special! Have children sponge-paint a 9-inch white paper plate with gray tempera paint. When the paint is dry, help children cut their plate in half and then cut a tail shape, as shown, out of one of the plate halves. Have them glue the tail to the other half to make a whale body. Then invite children to use a black marker to draw a face on their whale. Finally, have them glue on a blue construction-paper W to serve as a water spout. What wonderful whales!

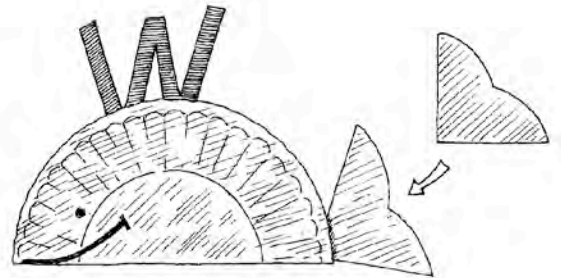

Game

W Is for What's in the Wagon?

Bring in a real wagon for this guessing game. (Or cover a large flat box with red paper, add black cardboard wheels and a handle to resemble a wagon.) Then gather some items that begin with W or duplicate the picture cards (page 145) to use instead. Put the items in the wagon and cover them with a towel. During group time, give children clues about one of the items in the wagon. For example, you might say, "This starts with a W and you wear it on your arm." (*watch*) Provide additional clues, if necessary, until children correctly guess the item. Then remove it from the wagon and show it to children. Continue until children have guessed all of the items in the wagon.

Movement

W Is for Web

Warm up children's arm muscles and work on their aim with this activity. Use masking tape to create a large web on the floor in an open area. Then tape a large die-cut letter W to the web. Provide children with beanbags (or small plastic chips, like checkers). Invite them to take turns standing behind a designated line and tossing their beanbag onto the web. Give one point to children each time their beanbag lands on the web, and five points if it lands on the W. Happy tossing!

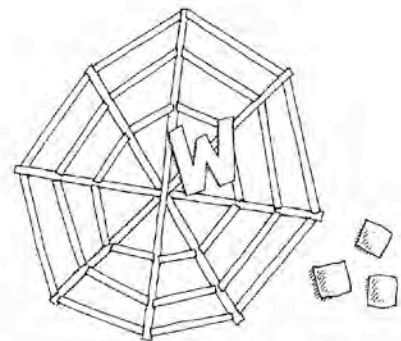

Snack

W Is for Watermelon

Real watermelon may not be in season, but children can make this look-alike snack anytime! To prepare, make watermelon-flavored gelatin and cut it into cubes. Then tint some whipped topping with green food coloring. To make the snack, children put a dollop of green whipped topping into the bottom of a clear plastic cup. They add a few cubes of watermelon gelatin and sprinkle on a few chocolate chip “seeds.” Yum!

Literature

W Is for *The Wheels on the Bus*

Read aloud Raffi’s *The Wheels on the Bus* (Crown Books for Young Readers, 1990) and then re-read it—or actually, sing it! Then try this easy follow-up activity. Have children brainstorm a list of words that begin with the sound of W. List their words on chart paper, then invite children to sing a variation of the traditional song using W words. Each time they repeat the song, have them use two W words from the list in the verse.

(sung to the tune of “The Wheels on the Bus”)

The *W* on the bus says, “[web] and [watch],
[Web] and [watch], [web] and [watch].”

The *W* on the bus says, “[web] and [watch],”
All through the town!

Letter Ww Mini-Book

Reinforce children’s knowledge of the letter W and their letter-writing skills with this mini-book. First, duplicate a class supply of the mini-book patterns (page 146). Ask children to color the cover and pages, write their name on the cover, and trace the letters on page 5. Then have children cut apart the pages, stack them in order behind the cover, and staple the mini-book together in the upper left corner. Read the mini-book aloud as a class, emphasizing the beginning sound of W in the appropriate words. Then send the mini-books home for children to share with their family.

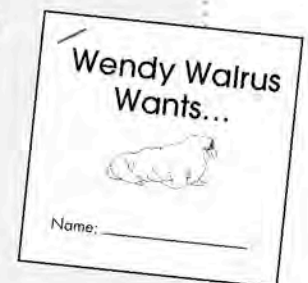

Ww

A B C D E F G H I J K L M

Watch Pattern

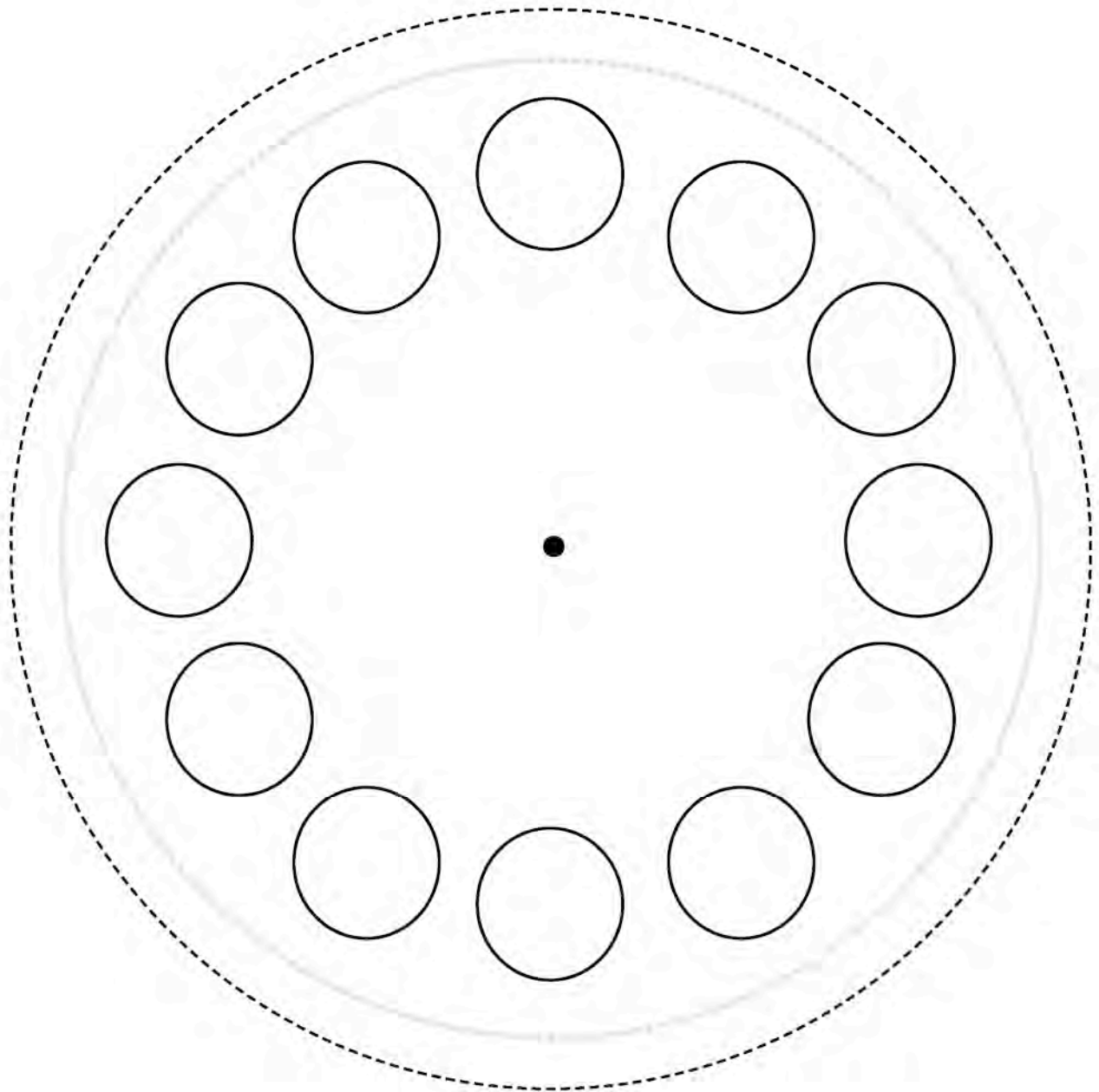

Letter W Picture Cards

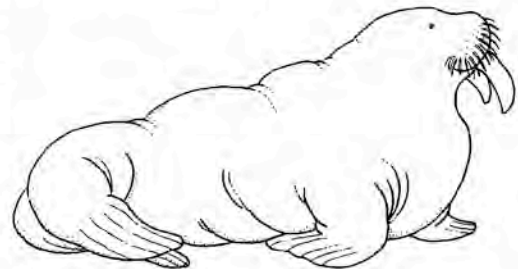
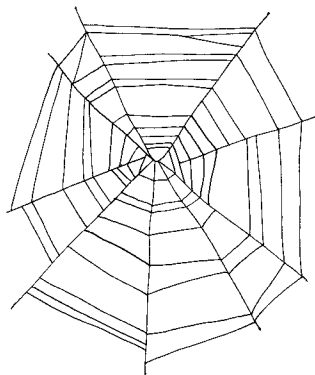
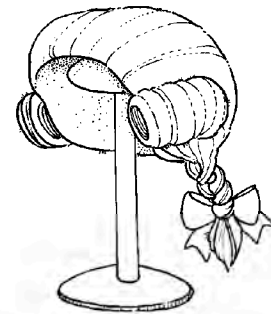
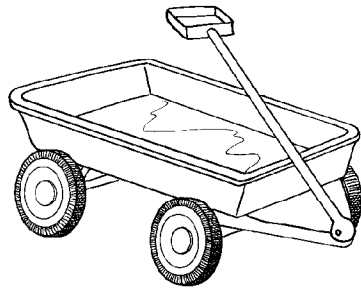
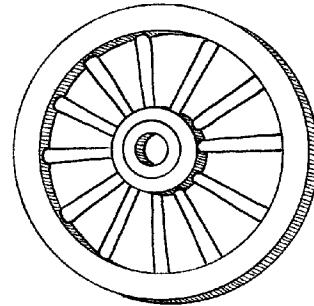
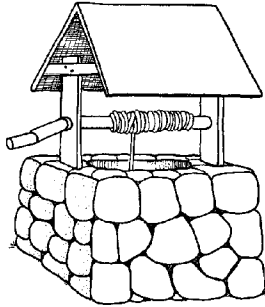
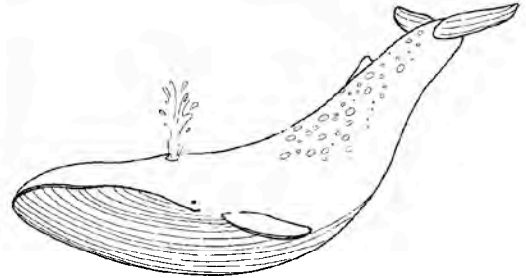
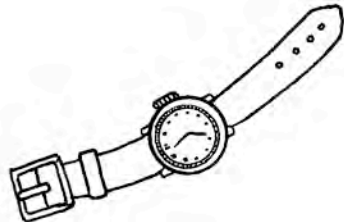

Wendy Walrus Wants...

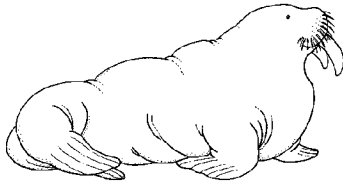

Name: _____

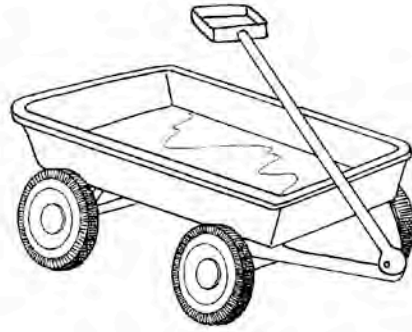

a **w**agon,

1

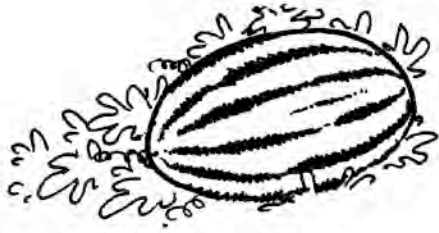

a **w**atermelon,

2

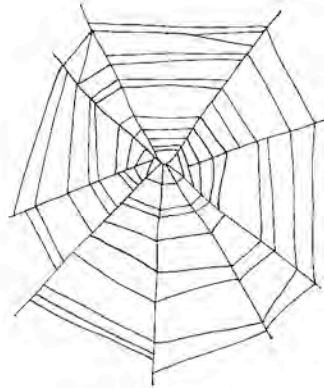

a **w**eb,

3

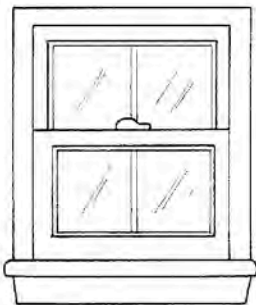

a **w**indow,

4



and the letter **Ww!**

5

Introducing Xx

Before beginning your study of the letter Xx, remove the picture cards for this letter (pages 245 and 247). Cut apart and laminate the cards for durability. Then write an uppercase and lowercase X on the chalkboard, or display a large letter card. Show children each picture card. As you name the picture, emphasize the sound of X in the word. Then point to and name the letter X on the board. Have children repeat the word and the sound of X in the word. After reviewing, keep the cards on display and use them throughout your letter study.

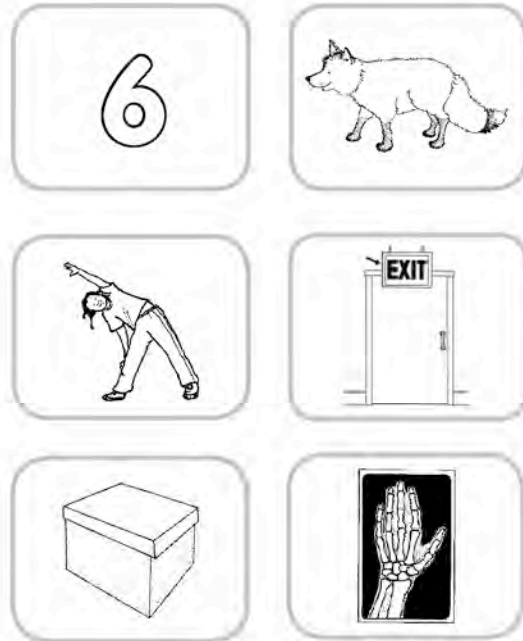

Math

X Is for Wax

Children will love this wacky way to write numbers! Bring in a few old white taper candles. Tell children that candles are made from wax, and that wax ends with the sound X. Then invite children to use the bottom of a candle to write the numbers 1 to 10 (or whatever numbers you want them to practice) on a sheet of white construction paper. Afterward, have them paint over the entire paper with blue or purple watercolor paint. The wax will resist the paint, making the numbers appear like magic!

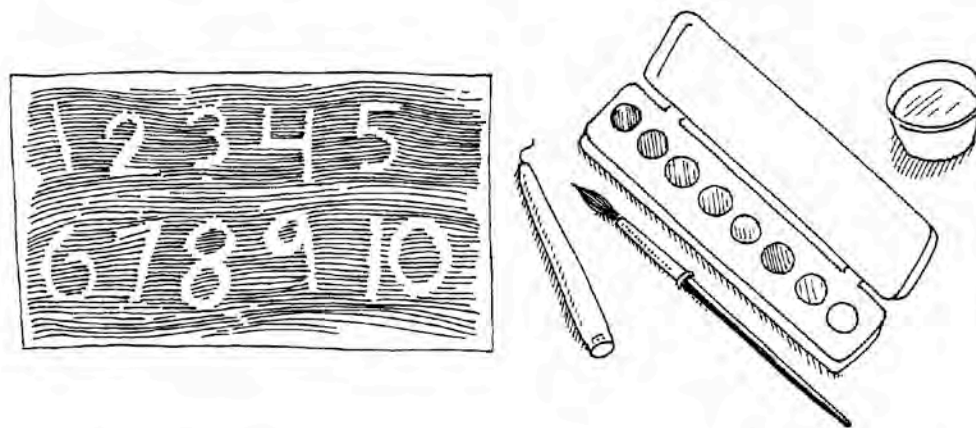

Craft

X Is for X-ray

To make a look-alike X-ray, have children make a white paint handprint on a sheet of black construction paper. Once the paint is dry, instruct them to glue cotton swabs along the fingers and thumb of their handprint to represent the bones in their fingers. (Cut the swabs to a shorter length, if necessary.) To make the bones in their hand, have children glue four cotton swab “bones” to the palm of their handprint, as shown. As children create, point out that *X-ray* begins with the letter *X*.

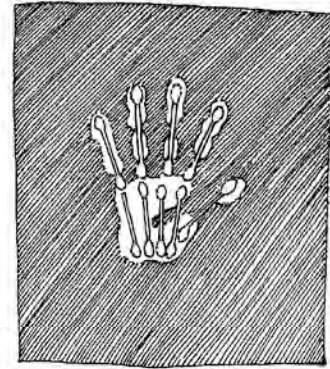

Game

X Is for Xs

Play a game of Tic-Tac-Toe with Xs, but no Os. Instead of Os, have one player use game markers that show pictures of items that begin or end with the sound of *X*. To prepare, duplicate and cut out the Tic-Tac-Toe game board and game markers on page 150. If desired, color the markers, then laminate all of the game pieces for durability. As pairs of children play, encourage them to name the letter *X* and the pictures each time they place one on the game board. Ask them to pay particular attention to the sound of *X* in the words. (You might prepare several games so that more than one pair can play at the same time.)

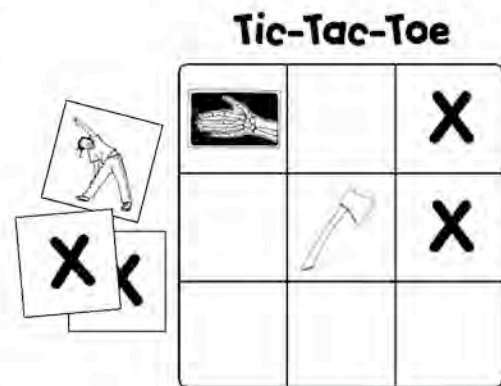

Movement

X Is for X Marks the Spot

X marks the spot for movement and fun! Use masking tape to make a large *X* in the center of an open floor area. Gather a small group of children and direct them to perform various actions on, over, or around the *X*. For example, you might have children jump over the *X*, gallop around the *X*, or take turns hopping on the *X*.

Snack

X Is for "X-cellent" Extra Cheese Pizza

Children are sure to be excited when they make this "X-cellent" pizza snack! For each child, cut a letter X from a piece of flatbread (or a tortilla). Help children spread pizza sauce over their flatbread X and then sprinkle on shredded mozzarella cheese. You might invite them to add extra cheese, reinforcing the sound of X in *extra* when you make the offer. Then bake the X-shaped pizzas at 400°F for 5 to 7 minutes, until the cheese is melted. Allow the snacks to cool before serving.



Literature

X Is for Fancy Nancy: Poison Ivy Expert

In the story *Fancy Nancy: Poison Ivy Expert* (HarperCollins, 2008) by Jane O'Connor, Nancy considers herself an expert on recognizing poison ivy. After sharing the book with children, ask them to see if they are experts at hearing the beginning and ending sound of X. Say aloud a list of words in which some contain the X sound, and some do not. Ask children to cross their arms in the air over their head to form a letter X whenever they hear a word with the sound of X. If the word does not contain an X, tell children to keep their arms by their side.

Some words that have X in them:

- xray
- fox
- extra
- explore
- ax
- exercise
- ox
- explain

Letter Xx Mini-Book

Reinforce children's knowledge of the letter X and their letter-writing skills with this mini-book. First, duplicate a class supply of the mini-book patterns (page 151). Ask children to color the cover and pages, write their name on the cover, and trace the letters on page 5. Then have children cut apart the pages, stack them in order behind the cover, and staple the mini-book together in the upper left corner. Read the mini-book aloud as a class, emphasizing the sound of X in the appropriate words. Then send the mini-books home for children to share with their family.

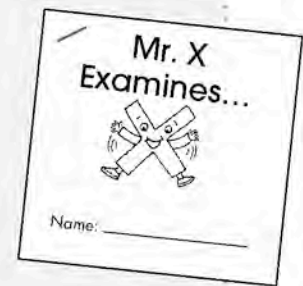





Xx

A B C D E F G H I J K L M

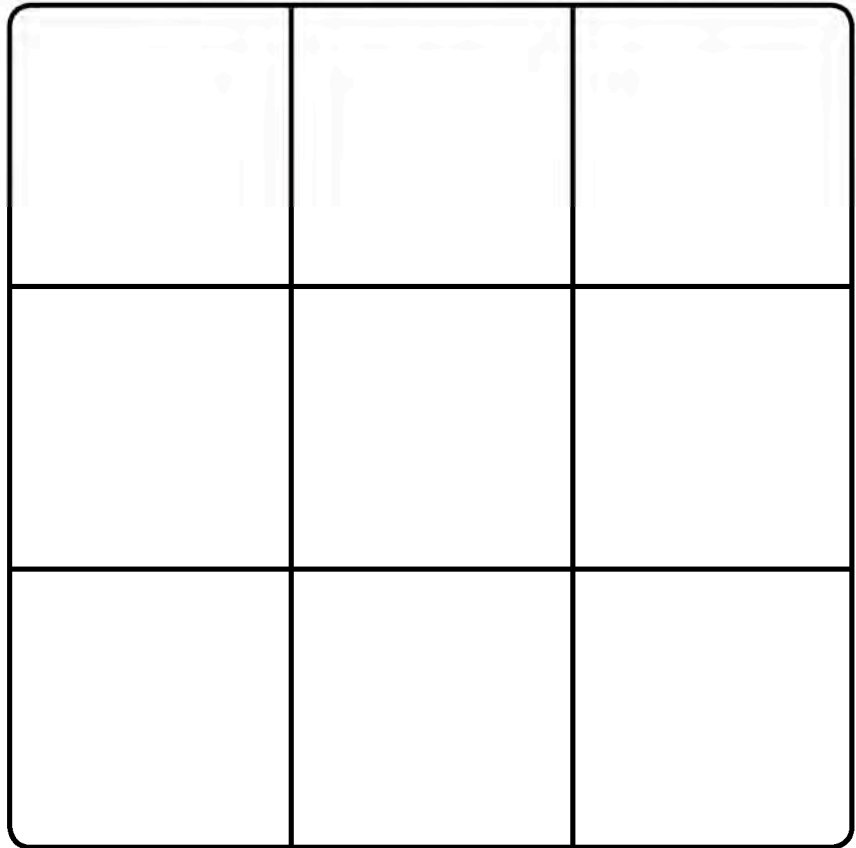
Tic-Tac-Toe
Game Board
and Game
Markers

Tic-Tac-Toe

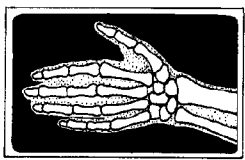
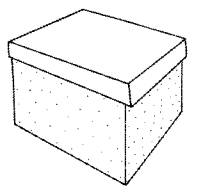

				
X	X	X	X	X

Mr. X Examines...



Name: _____

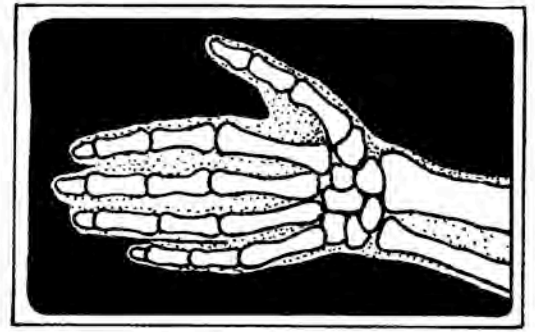

an **x**ray,

1



an **e**xit,

2

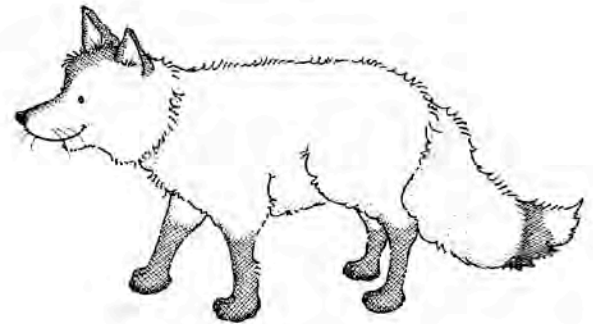

a **f**ox,

3

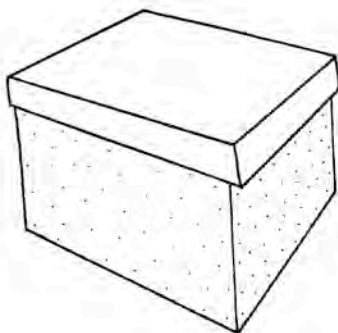

a **b**ox,

4



and the letter **Xx**!

5

Introducing Yy

Before beginning your study of the letter Yy, remove the picture cards that begin with this letter (pages 249 and 251). Cut apart and laminate the cards for durability. Then write an uppercase and lowercase Y on the chalkboard, or display a large letter card. Show children each picture card. As you name the picture, emphasize its beginning sound. Then point to and name the letter Y on the board. Have children repeat the word and the sound of Y at the beginning of the word. After reviewing, keep the cards on display and use them throughout your letter study.



Math

Y Is for Yogurt

Children practice their graphing skills after they taste-test a yummy food that starts with Y—yogurt! In advance, duplicate a class supply of the opinion cards on page 155. Title a two-column chart with “Do You Like This Yogurt?” and label each column either “Yes” or “No.” Then invite children to taste a certain flavor of yogurt, such as strawberry. If they like that flavor, have them use tape to attach a “yum” card in the “Yes” column. If they don’t like it, have them put a “yuck” card in the “No” column. After completing the chart, discuss the results. Then, if you wish, have children taste-test another yogurt flavor and graph their opinion about it.

Do You Like This Yogurt? Strawberry	
Yes	No
yum! 😊	yuck! ☹️
yum! 😊	yuck! ☹️
yum! 😊	
yum! 😊	

Craft

Y Is for Yarn You

A paper plate, some yarn, and glue—that's all it takes to make a "You!" Set out several different colors of yarn, using colors that correlate to children's eye and hair colors. Include red and a few flesh colors of yarn, as well. Then invite children to make a paper-plate version of themselves by cutting and gluing yarn pieces onto a paper plate to represent their facial features (such as eyes, nose, and mouth). Have them also cut yarn in a color and length that resembles their hair to glue onto their plate. Display the completed projects with the title, "Y Is for You...in Yarn!" Label children's paper-plate self-portrait with their name for others to admire.

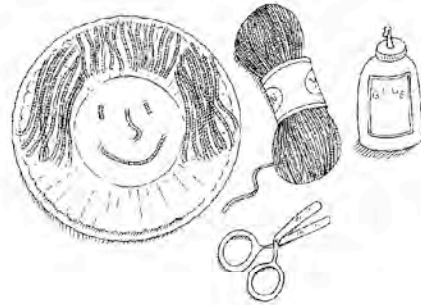

Game

Y Is for Yippee and Yawn

Play this easy game to give children practice with recognizing the letter Y. Make a set of letter cards, labeling most of the cards with an uppercase or lowercase Y, and a few cards with other letters. Tell children that when you hold up a card showing a Y, they should shout, "Yippee!" If the card has a letter other than Y, they should remain quiet and pretend to yawn. Then show the cards one at a time and watch children get excited about the letter Y!

Movement

Y Is for Yoga

Yoga is perfect to do when studying the letter Y! For a few starter positions, duplicate the yoga cards on page 156. (If desired, make enlarged copies of the cards.) Color, cut out, and laminate the cards for durability. Then have children spread out in a large area where they can move without bumping into each other. Tell them that they will do some yoga poses, pointing out that *yoga* begins with the letter Y. Display one yoga card at a time and invite children to imitate the pose. If needed, demonstrate the pose yourself to help children see how to position their body. For more yoga positions, you might refer to *The Kids' Yoga Deck: 50 Games and Poses* (Chronicle Books, 2006) by Annie Buckley.

Snack

Y Is for Yellow

Invite children to create a yummy Y with some common yellow snacks. Simply mix together several kinds of dry, yellow cereal, such as Corn Pops®, Honeycombs®, and Corn Chex® cereal. Then duplicate a class supply of the letter Y mat on page 155. Distribute a mat and a paper cup full of the cereal mix to children. Ask them to use the cereal to fill in the letter Y on their mat, creating a pattern with the different kinds of cereal. Afterward, invite children to snack on their yummy patterns!

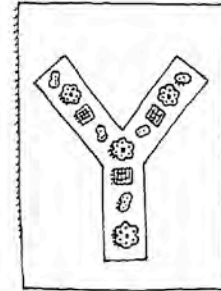

Literature

Y Is for Yes Day!

Every kid wishes for a day like the one in Amy Krouse Rosenthal's *Yes Day!* (HarperCollins, 2009). After reading this story about a day when grownups say "yes" to everything, ask children to say "yes" to some words that begin with Y. Say a list of words, in which most begin with Y, and a few begin with other letters. Ask children to say "yes," each time they hear a word that begins with the Y sound. If they hear a word that begins with a letter other than Y, they remain silent.

Some words that begin with Y:







yak
yard
yet
young
yo-yo
yesterday
yield
yacht

Letter Yy Mini-Book

Reinforce children's knowledge of the letter Y and their letter-writing skills with this mini-book. First, duplicate a class supply of the mini-book patterns (page 157). Ask children to color the cover and pages, write their name on the cover, and trace the letters on page 5. Then have children cut apart the pages, stack them in order behind the cover, and staple the mini-book together in the upper left corner. Read the mini-book aloud as a class, emphasizing the beginning sound of Y in the appropriate words. Then send the mini-books home for children to share with their family.



Opinion Cards

yum! 	yuck! 
yum! 	yuck! 
yum! 	yuck! 

Letter Y Mat

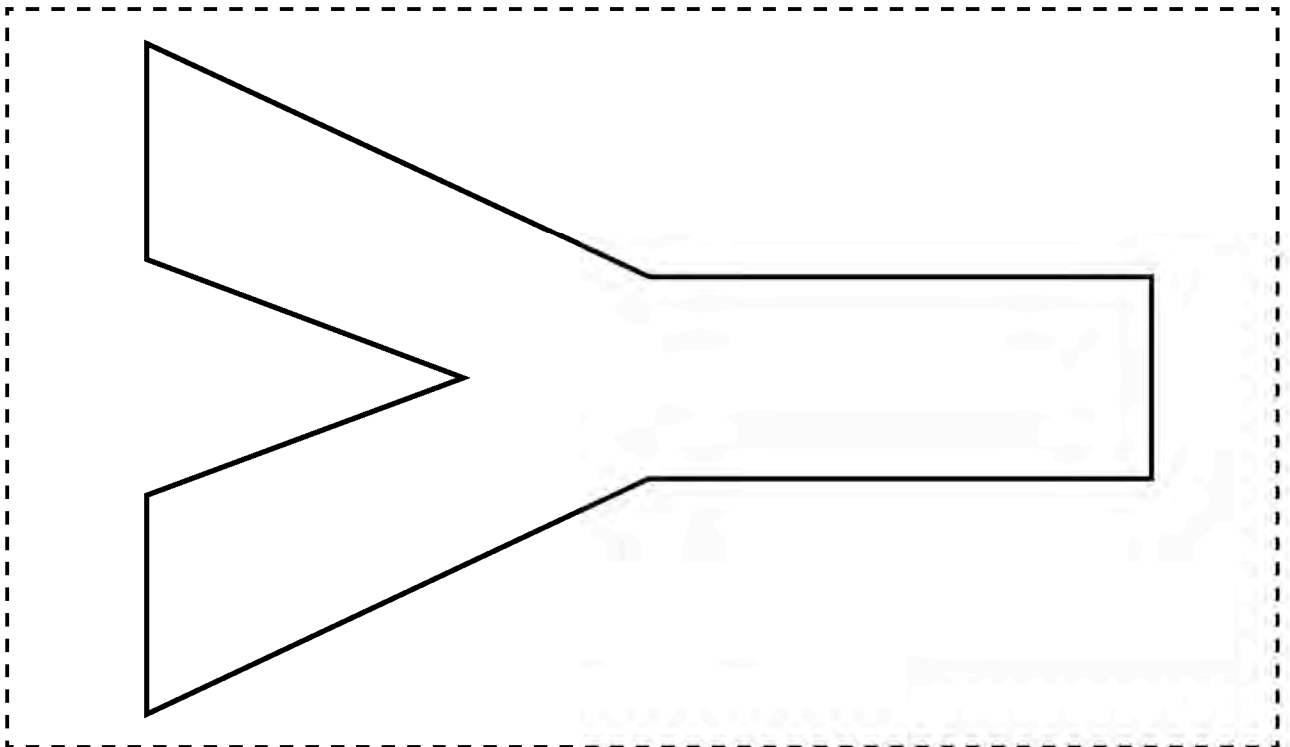

Yy

A B C D E F G H I J K L M

Yoga Cards



Cat pose



Child's pose

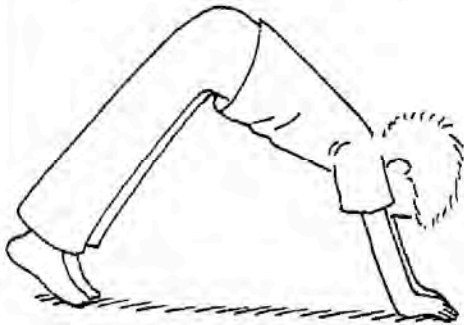

Downward dog
pose



Tree pose

Yasmin Yak Likes...



Name: _____



a **y**o-yo,

1

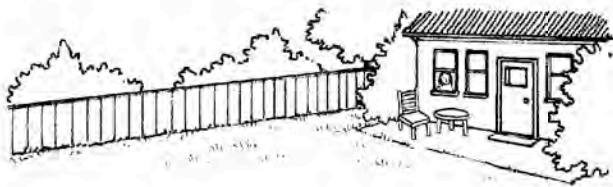

a **y**ard,

2

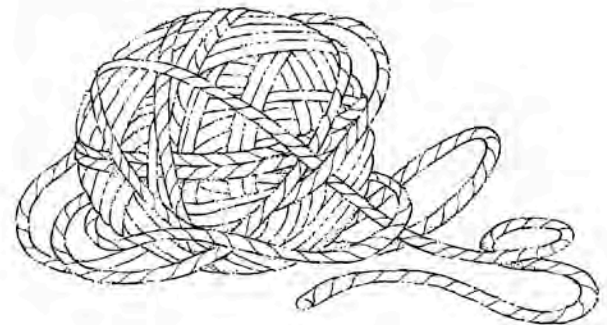

yarn,

3



yogurt,

4



and the letter **Yy**!

5

Introducing Zz

Before beginning your study of the letter Zz, remove the picture cards that begin with this letter (pages 251 and 253). Cut apart and laminate the cards for durability. Then write an uppercase and lowercase Z on the chalkboard, or display a large letter card. Show children each picture card. As you name the picture, emphasize its beginning sound. Then point to and name the letter Z on the board. Have children repeat the word and the sound of Z at the beginning of the word. After reviewing, keep the cards on display and use them throughout your letter study.

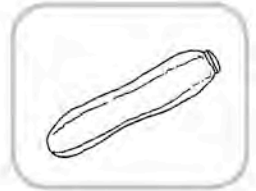
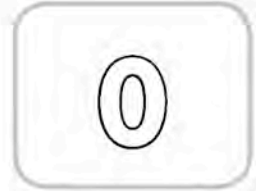

Math

Z Is for Zoo

Zoo animals are perfect for some graphing practice! To begin, gather some plastic zoo animals and put them in a basket. (Or copy, color, and cut out a few sets of the zoo animal cards on page 162.) Label a separate index card with the name of each kind of animal in the collection and then line up the cards to create a tabletop graph. To use, invite children to take turns choosing an animal and placing it with the corresponding label. Once the tabletop graph is completed, examine and discuss the results with children. Help children compare the number of animals in each column, emphasizing the terms *most*, *fewest*, and *same*.



elephant



zebra



lion

Craft

Z Is for Zebra

Children will zoom on over to the art center to make these black-and-white beauties! To prepare, copy and cut out the zebra pattern (page 161) to make templates for children to trace. Then give children a shallow box lined with white construction paper. Have them place a few marbles in black tempera paint and then roll the marbles around in the box to marble-paint the paper. When the paint dries, help children trace a zebra template onto their painting and cut out the pattern. As they work, remind children that *zebra* begins with Z. Then invite them to glue on a wiggle eye and add a tail and mane using black yarn. Finally, have them draw additional details on their zebra with a black marker.

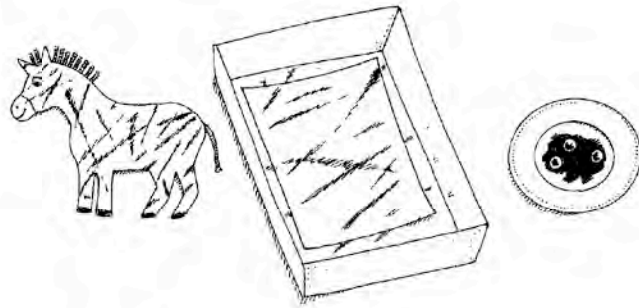

Game

Z Is for Z Zone

Use masking tape to make a large Z on the floor in an open area of your classroom. Explain to children that this area is the “Z Zone.” Tell them that to get into the Z Zone, they must name a word that begins with the sound of Z when their name is called. Once all the children have gained admission to the Z Zone, tell them now they must name another Z word to get out!

Movement

Z Is for Zigzag

Invite children to name the movements that they’ll perform for this easy activity. Simply use masking tape to make a long zigzag line on the floor in an open area. Have children line up at one end of the line. Then name an action, such as “tiptoe,” and invite children to perform that action as they move along the line. For additional rounds, have children take turns naming an action for everyone to perform.

Snack

Z Is for Zesty Zucchini Zs

This snack is absolutely “Z-licious!” Wash a few zucchini, trim the ends off of each one, and cut them into 3- to 4-inch sections. Then cut each section into sticks. Give children three zucchini sticks on a 9-inch paper plate, along with a squirt of zesty Italian dressing to the side. Ask them to arrange their zucchini sticks to form the letter Z. Point out that both *zucchini* and *zesty* begin with Z. Then invite children to dip their sticks into the dressing and eat them up!

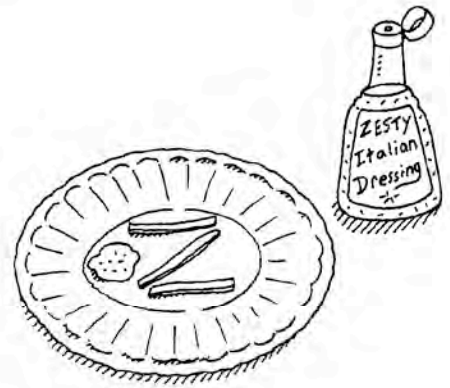

Literature

Z Is for Going to the Zoo

After reading aloud *Going to the Zoo* (HarperCollins, 1996) by Tom Paxton, invite children to do this letter-recognition activity. Make several copies of the zoo animal cards (page 162) on white construction paper. Label the back of most of the cards with an uppercase or lowercase Z, and a few with other letters. Color and cut out the cards and laminate for durability. During group time, draw a large box on a white board to represent a zoo. Distribute the animal cards to children and have them take turns telling whether or not their card has a Z on it. If so, children put their card in the zoo on the board, using removable adhesive to attach it. If their card has a letter other than Z, children set it aside.

Letter Zz Mini-Book

Reinforce children’s knowledge of the letter Z and their letter-writing skills with this mini-book. First, duplicate a class supply of the mini-book patterns (page 163). Ask children to color the cover and pages, write their name on the cover, and trace the letters on page 5. Then have children cut apart the pages, stack them in order behind the cover, and staple the mini-book together in the upper left corner. Read the mini-book aloud as a class, emphasizing the beginning sound of Z in the appropriate words. Then send the mini-books home for children to share with their family.

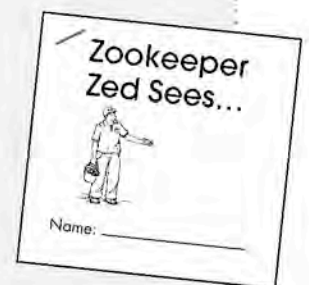

Zebra Pattern

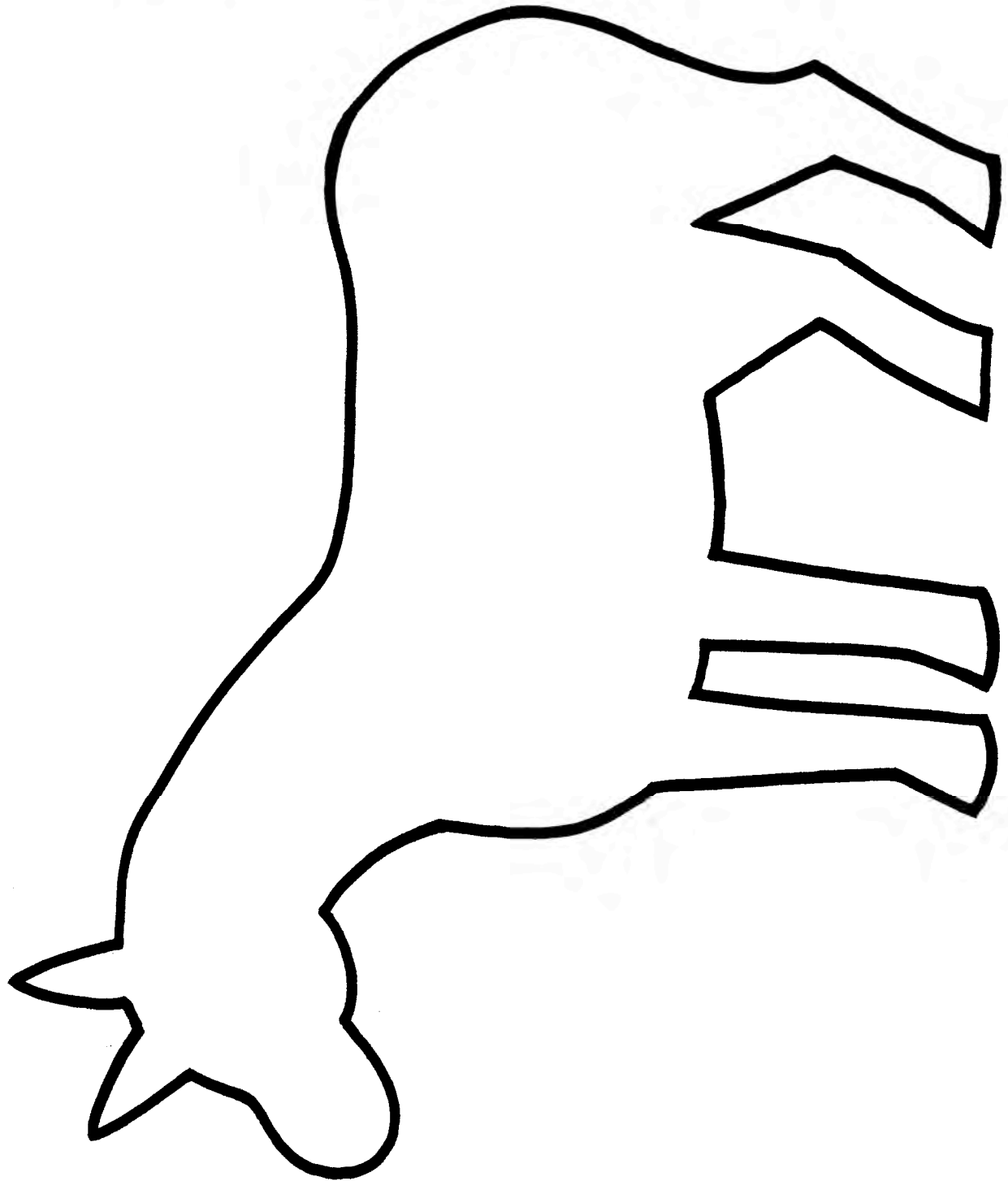

Zz

A B C D E F G H I J K L M

Zoo Animal Cards

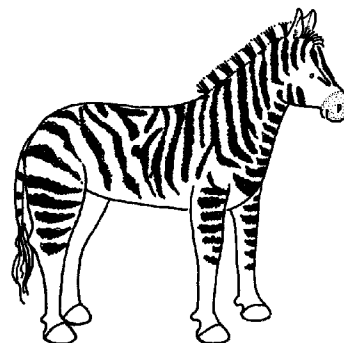
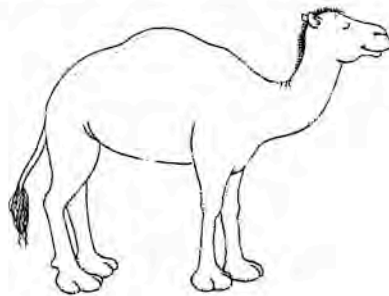
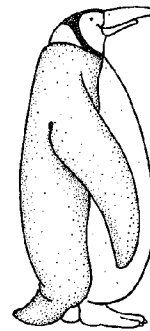
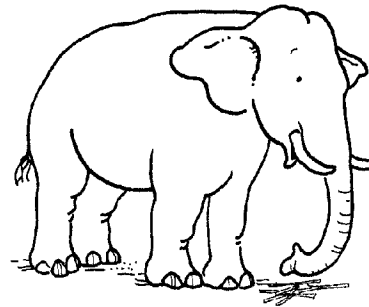
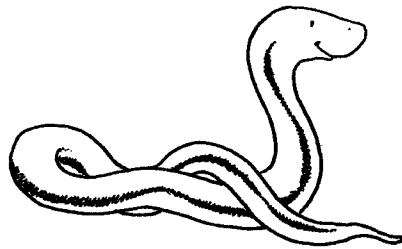
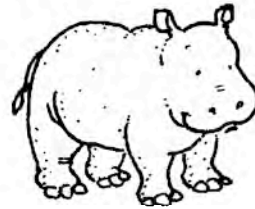

Zookeeper Zed Sees...



Name: _____



a **z**ebra,

1

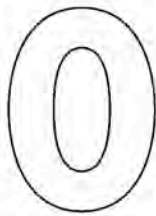

a **z**ero,

2

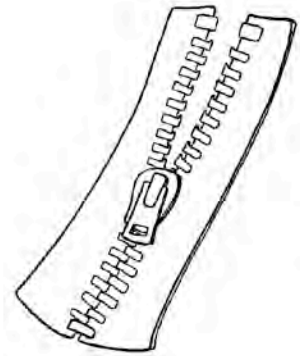

a **z**ipper,

3



a **z**igzag,

4



and the letter **Zz**!

5

Name: _____ Date: _____

A A

a a

Name: _____ Date: _____

B B

b b

Name: _____ Date: _____

C C

c c

The Big Book of Alphabet Activities © 2010 by Ada Goren, Scholastic Teaching Resources (page 165)

Name: _____ Date: _____

D D

d d

The Big Book of Alphabet Activities © 2010 by Ada Goren, Scholastic Teaching Resources (page 165)

Name: _____ Date: _____

E E

e e

Name: _____ Date: _____

F F

f f

Name: _____ Date: _____

G G

g g

Name: _____ Date: _____

H H

h h

Name: _____ Date: _____



Name: _____ Date: _____

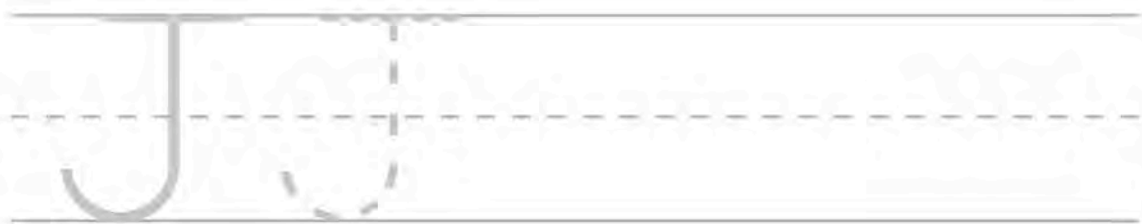

Name: _____ Date: _____



Name: _____ Date: _____



Name: _____ Date: _____

M M (dashed) M (dashed)

m m (dashed) m (dashed)

Name: _____ Date: _____

N N (dashed) N (dashed)

n n (dashed) n (dashed)

Name: _____ Date: _____

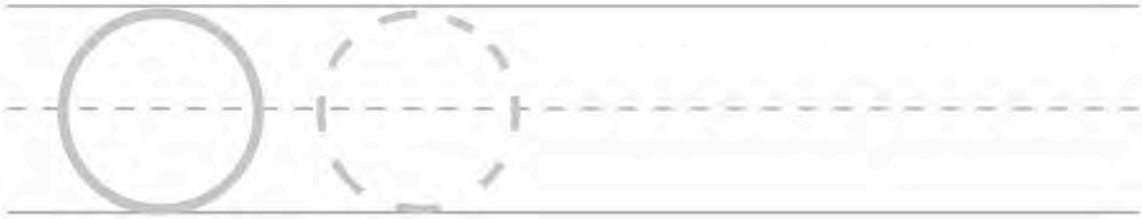

Name: _____ Date: _____



Name: _____ Date: _____

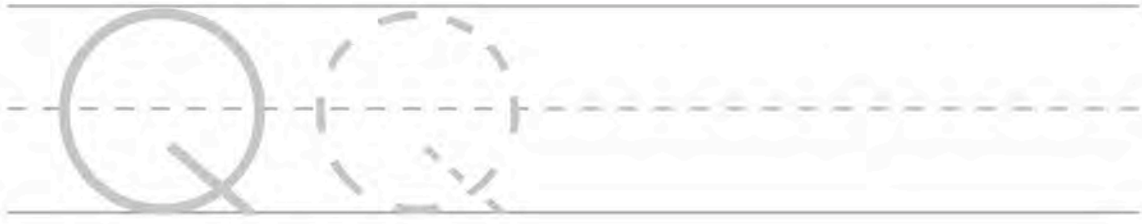

Name: _____ Date: _____

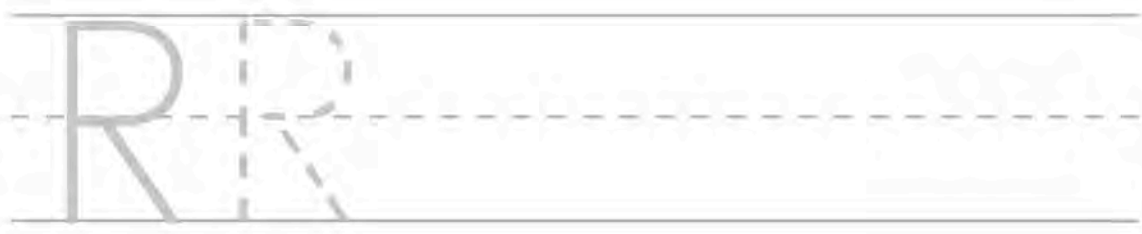

Name: _____ Date: _____

S S

S S

Name: _____ Date: _____

T T

T T

Name: _____ Date: _____

U U

u u

Name: _____ Date: _____

V V

v v

Name: _____

Date: _____



Name: _____

Date: _____



Name: _____ Date: _____



Name: _____ Date: _____



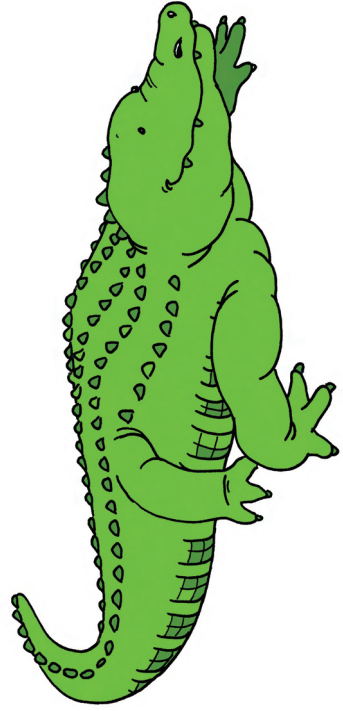
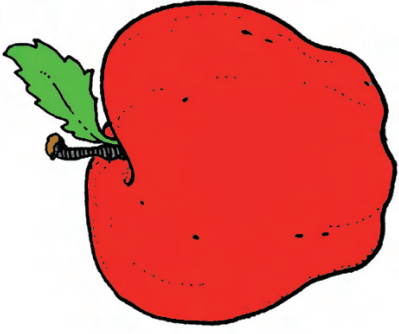

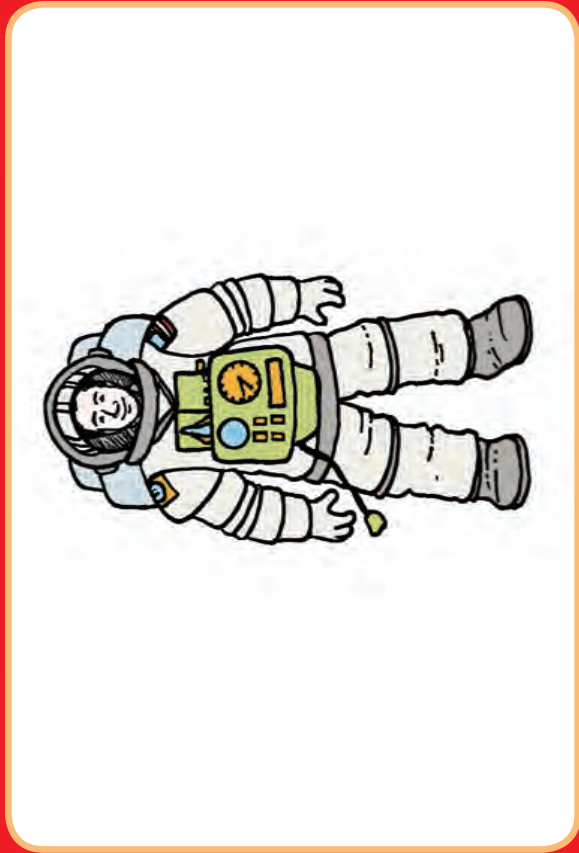
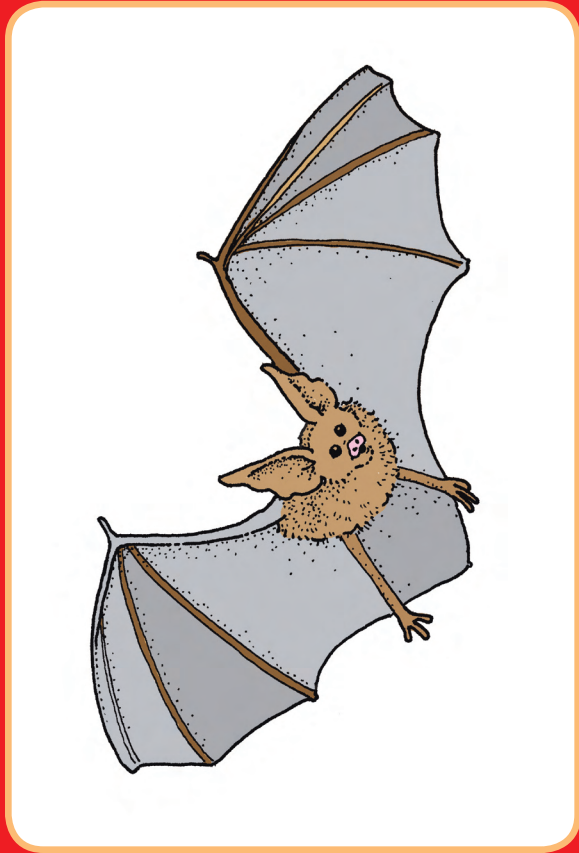

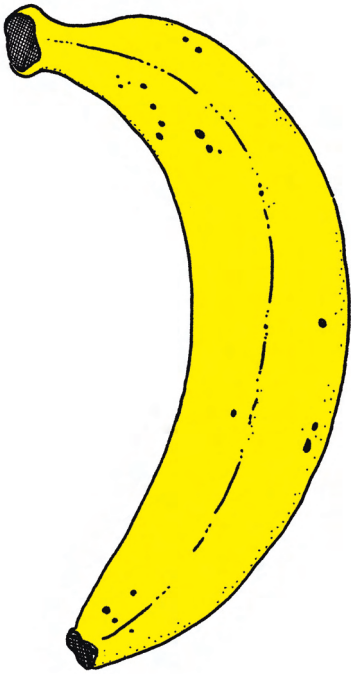

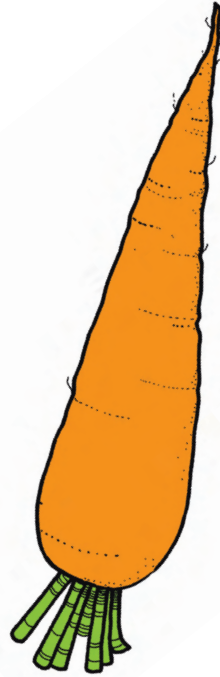
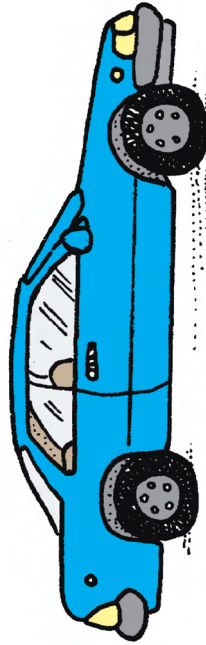

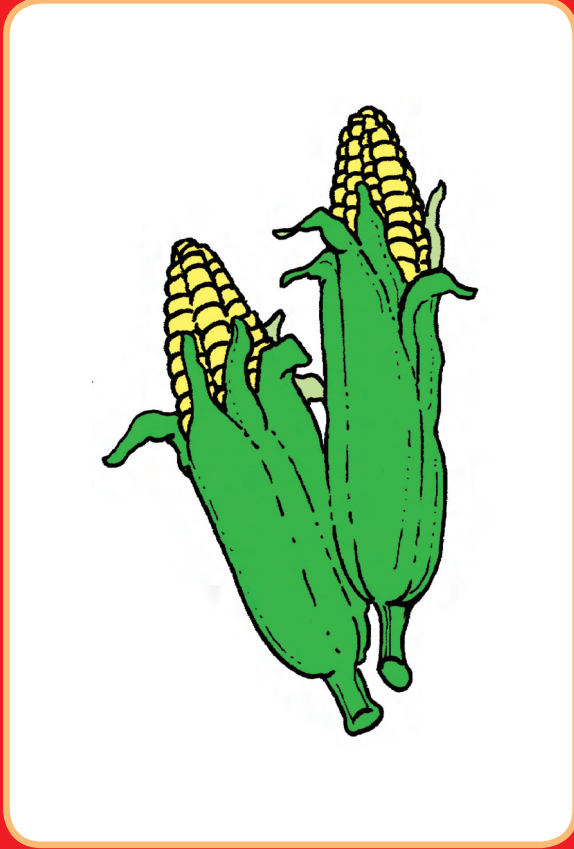
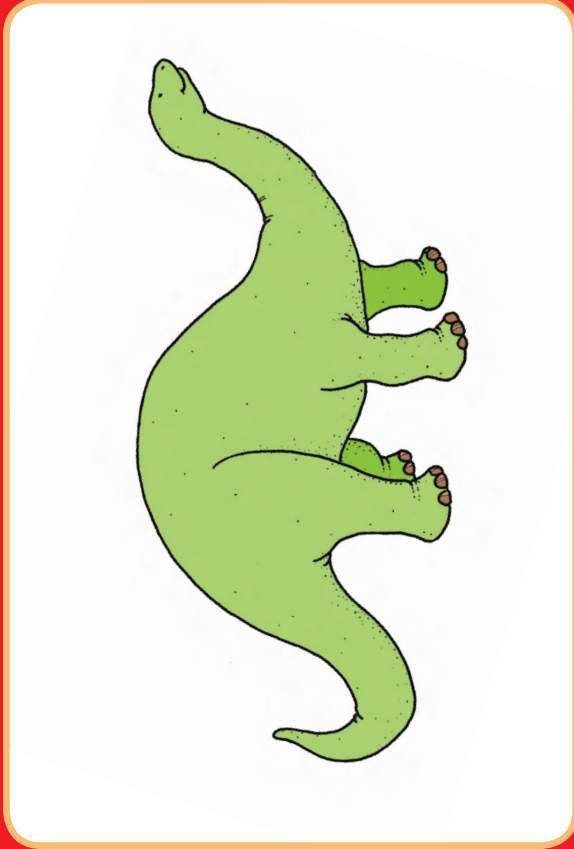
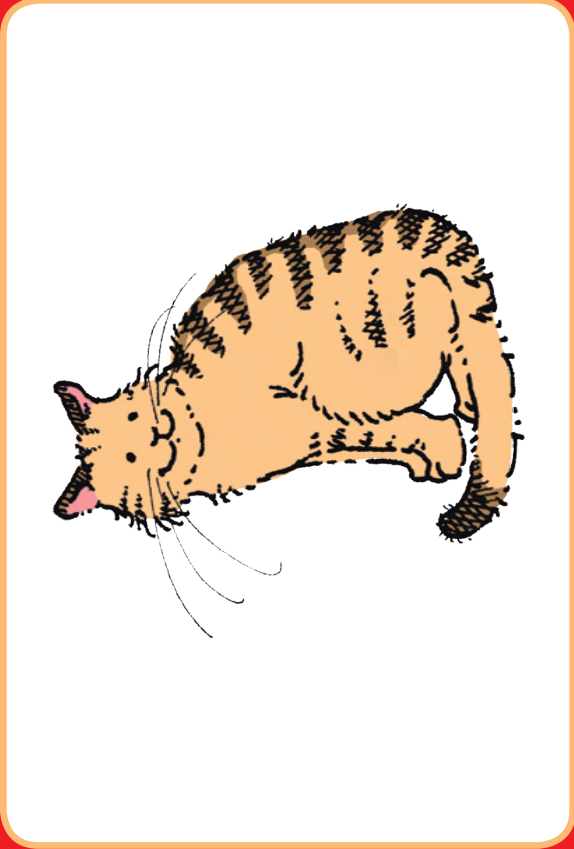
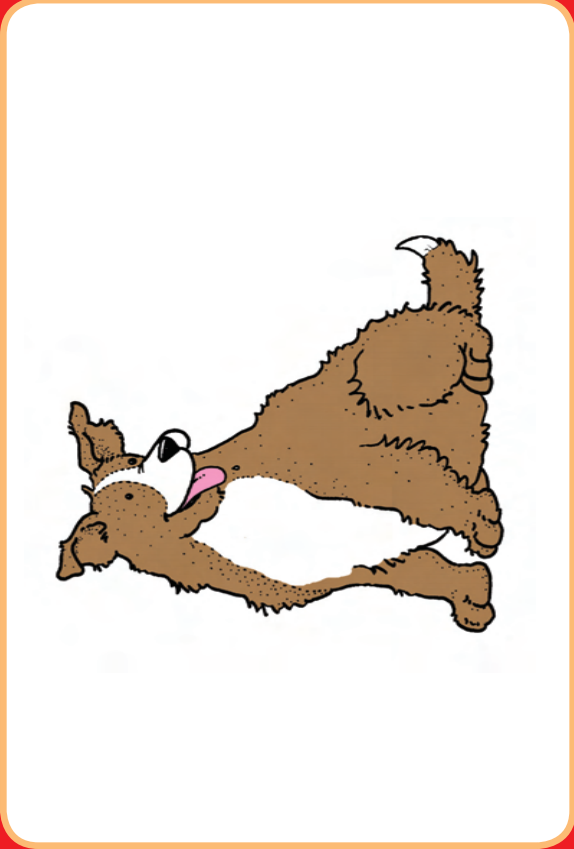

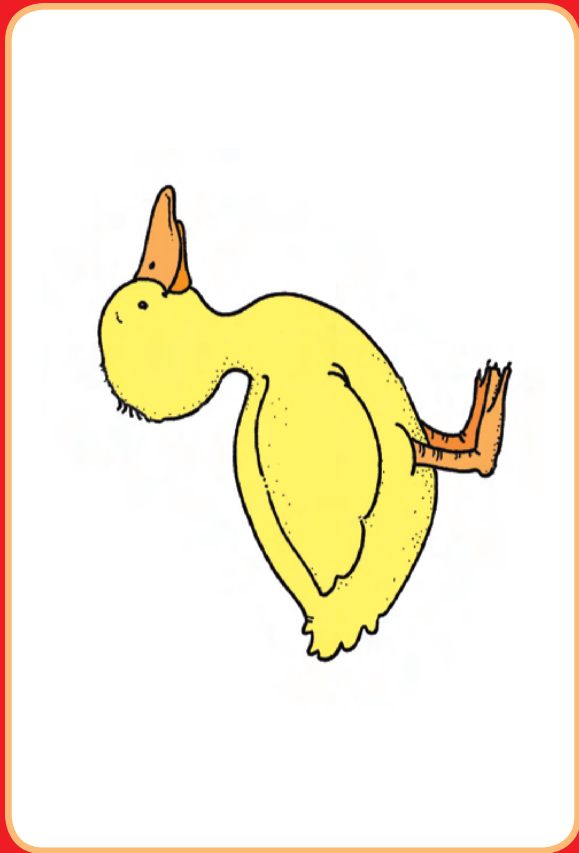
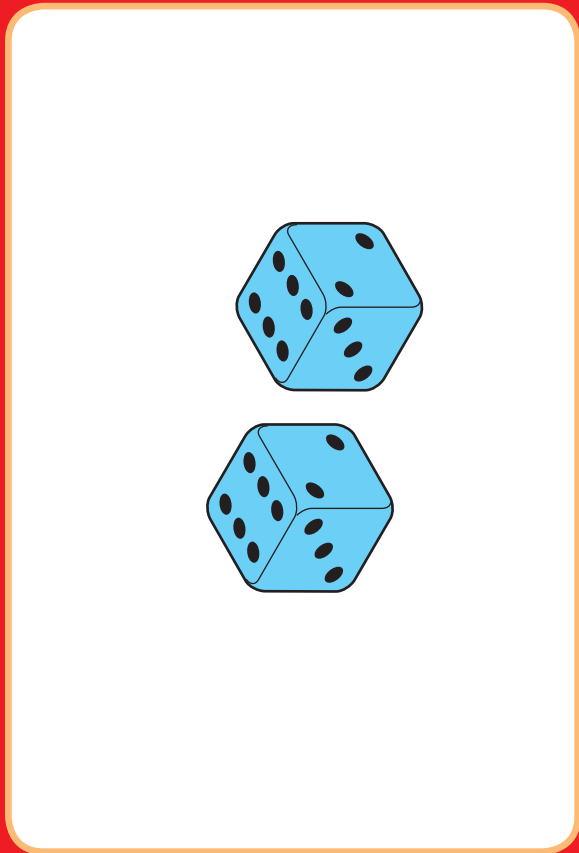
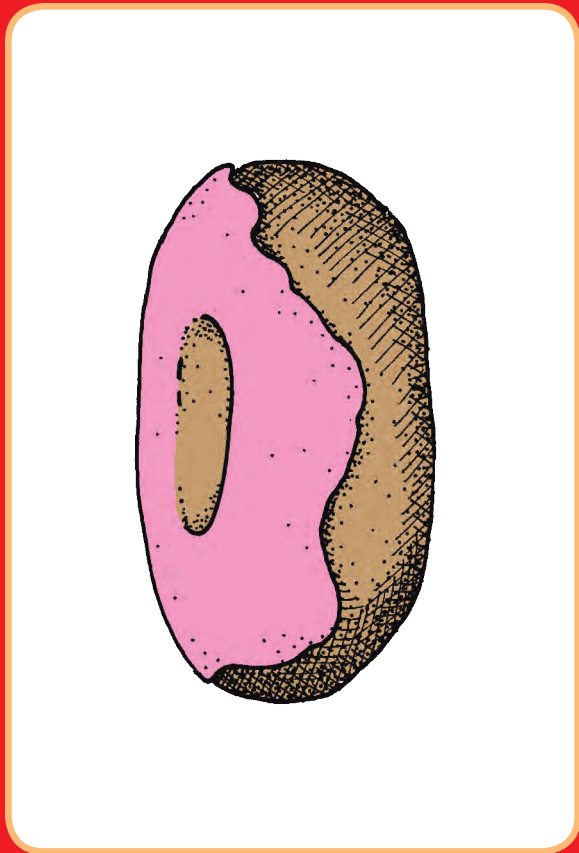
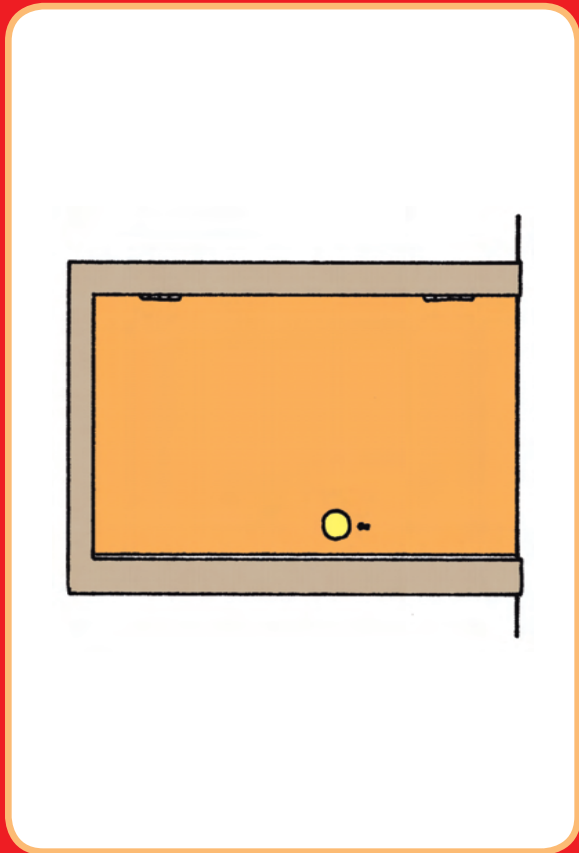

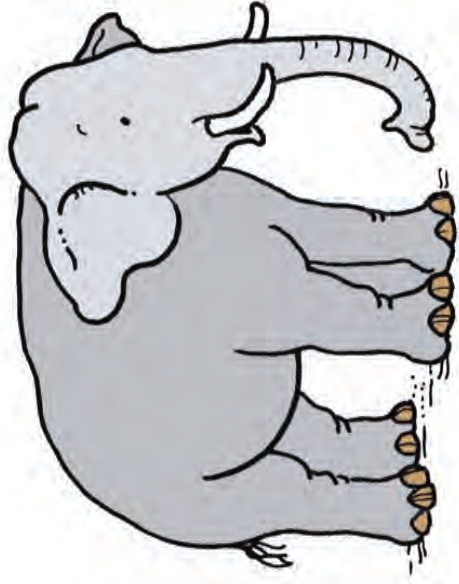
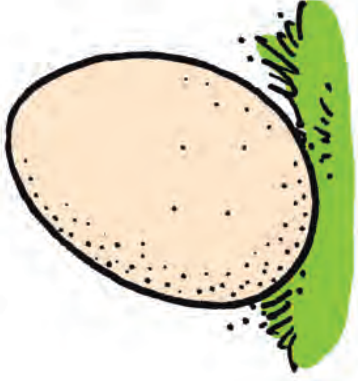

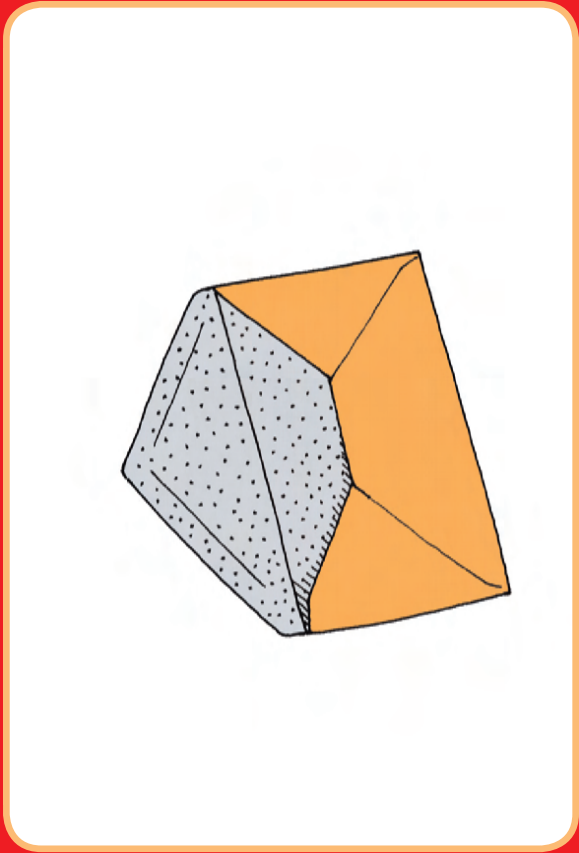
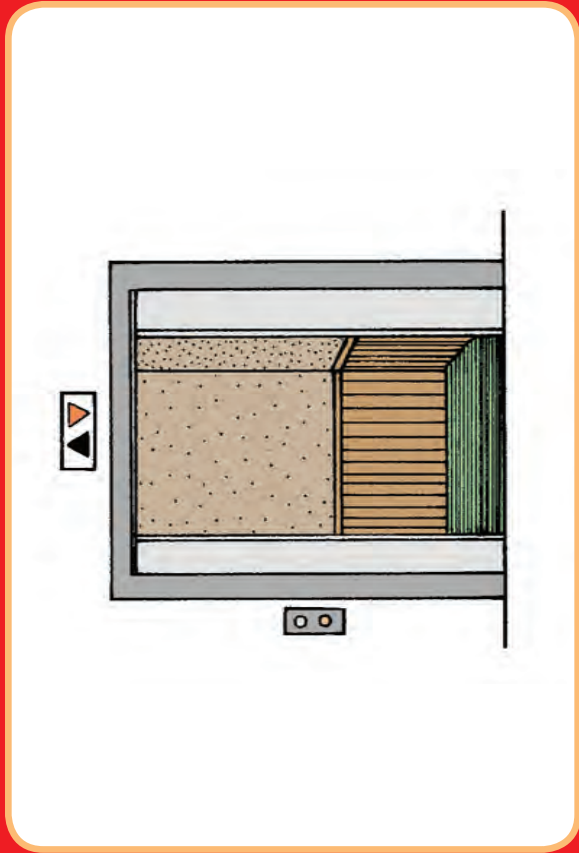
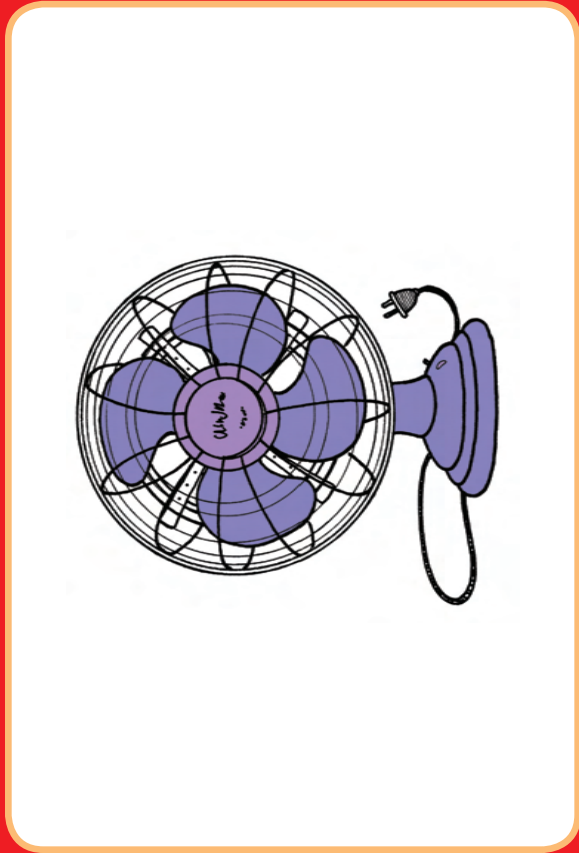

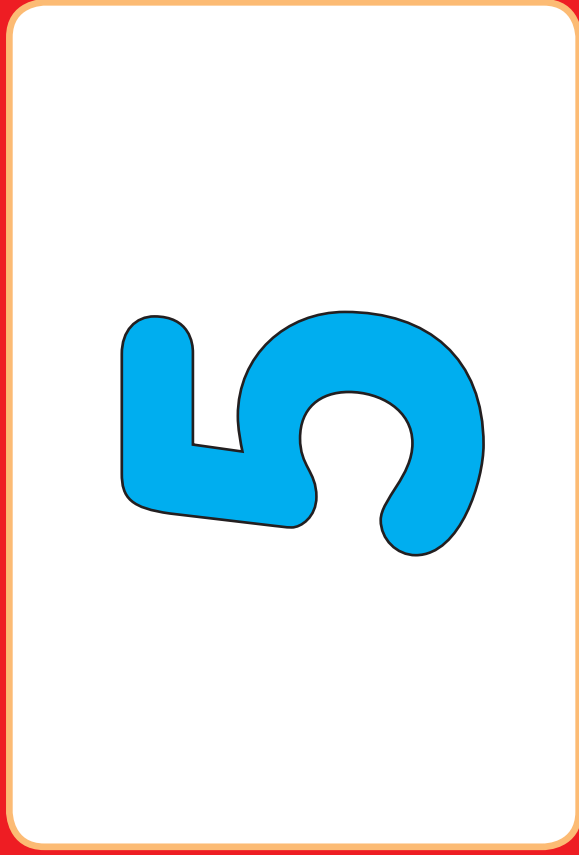
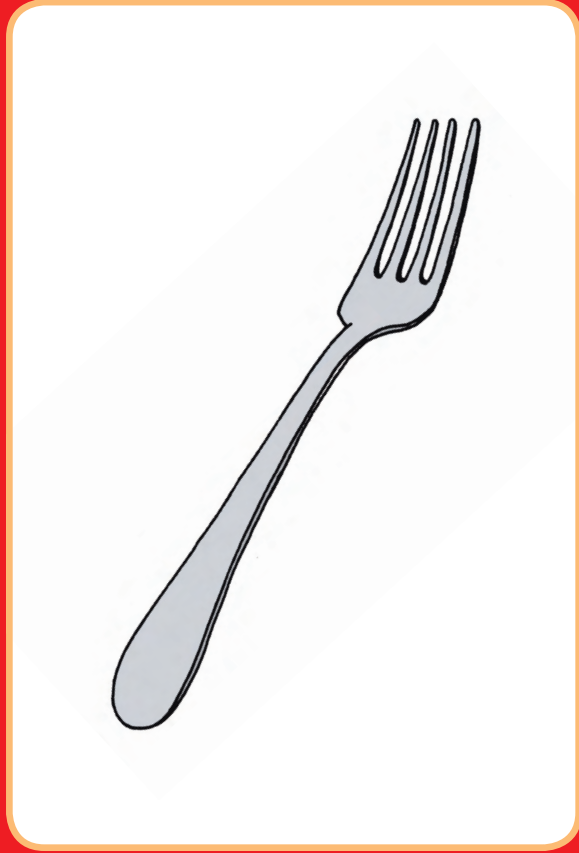
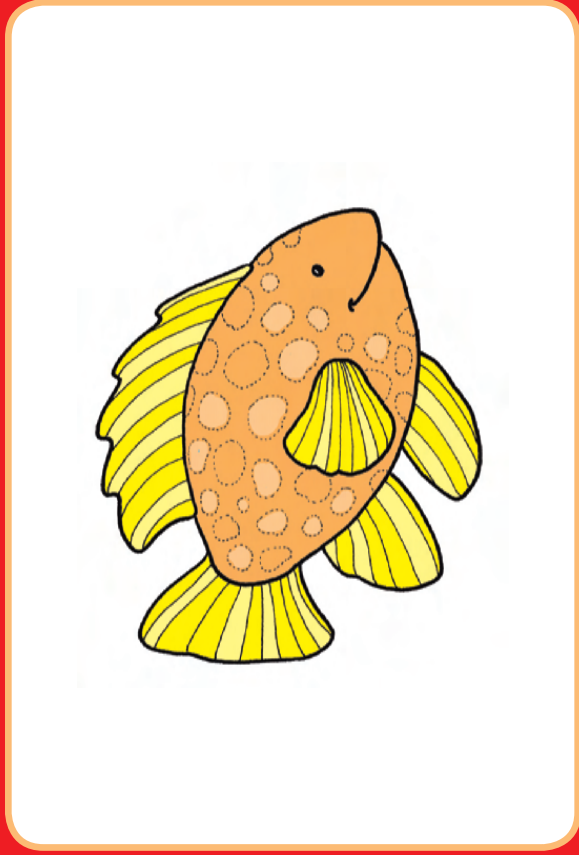

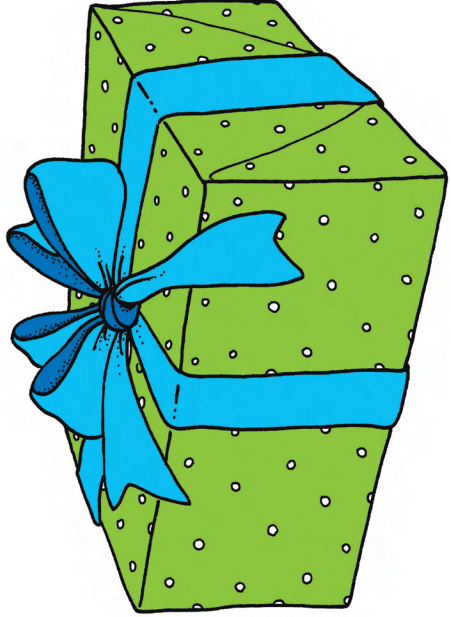
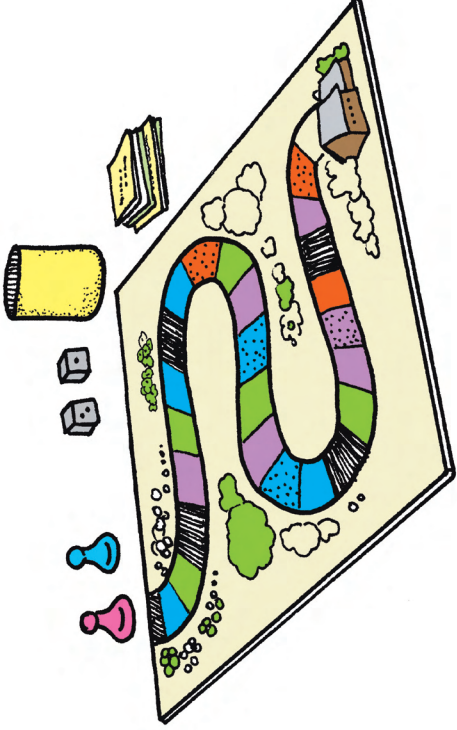

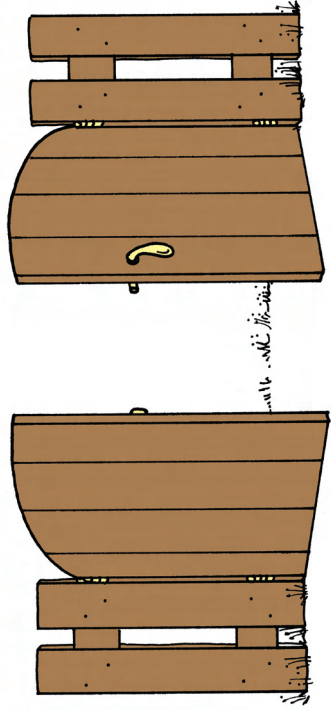
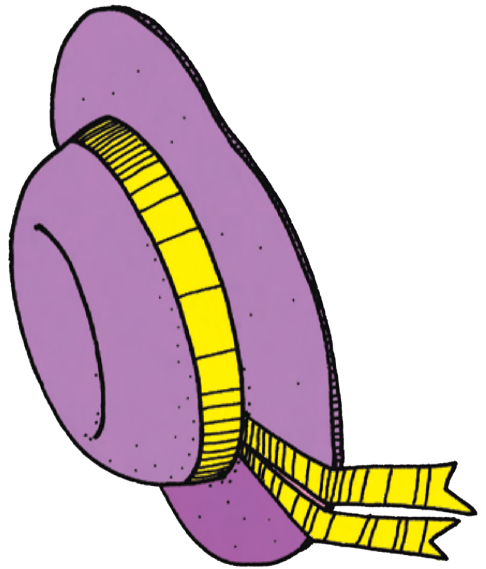
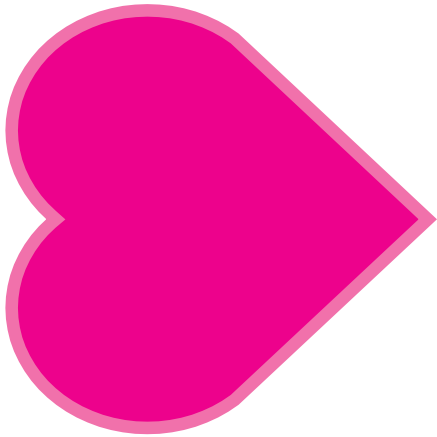

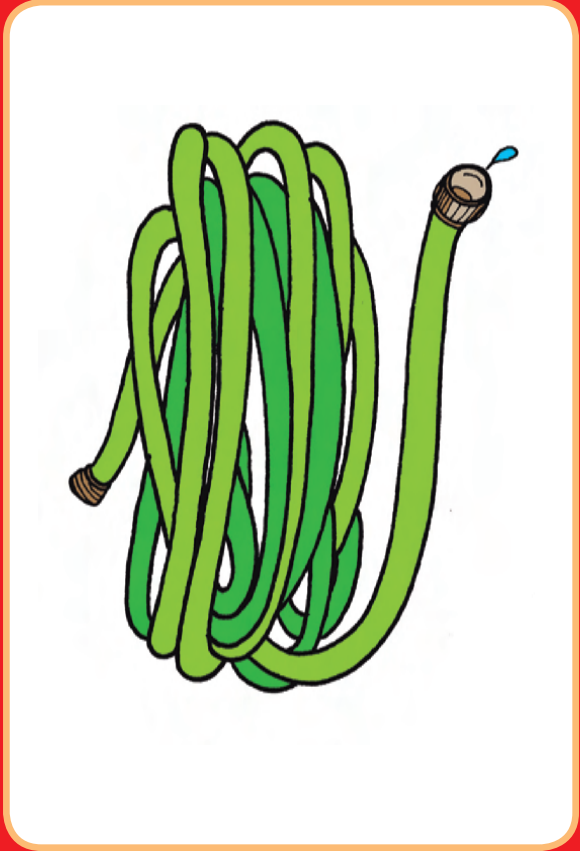
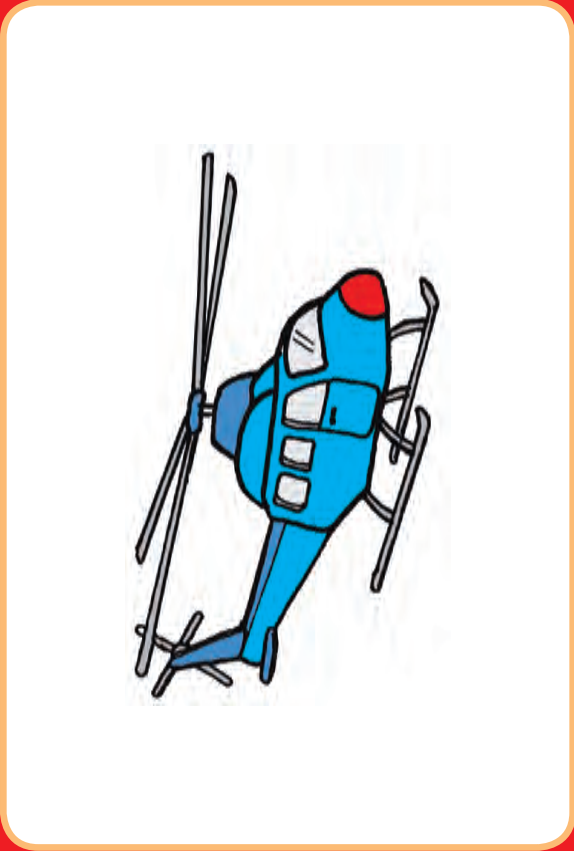
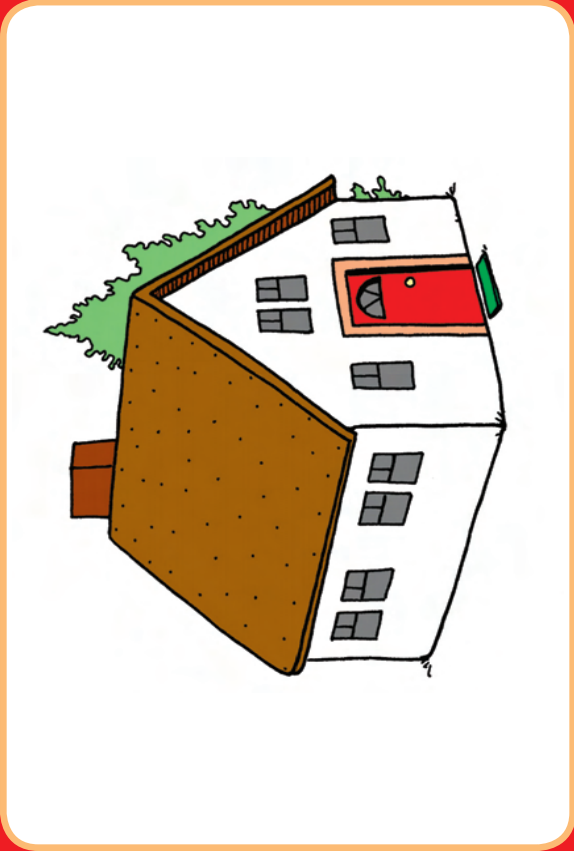

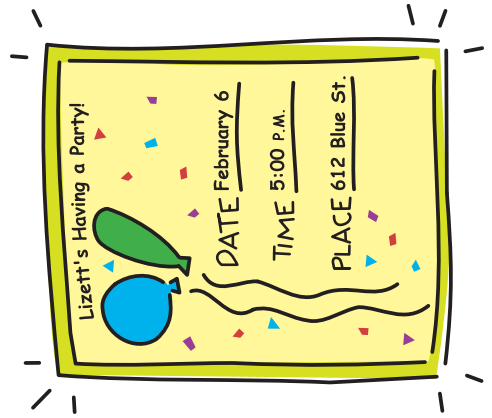
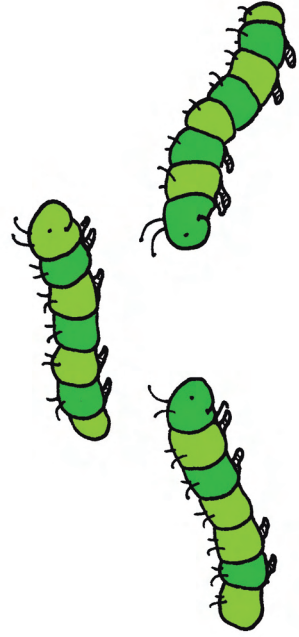
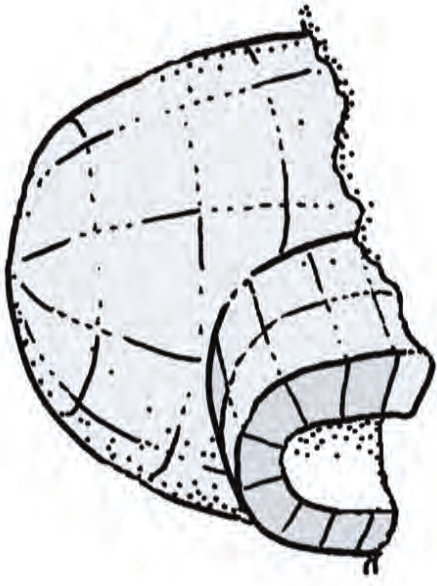
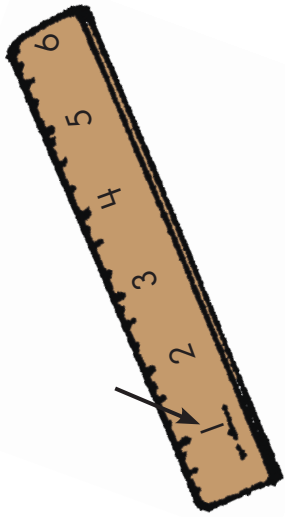

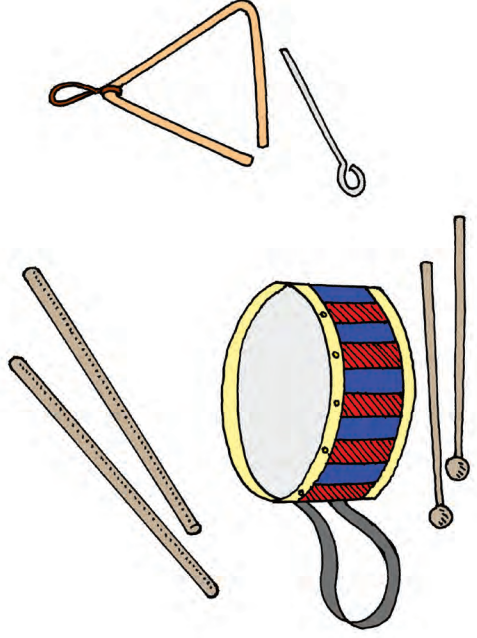
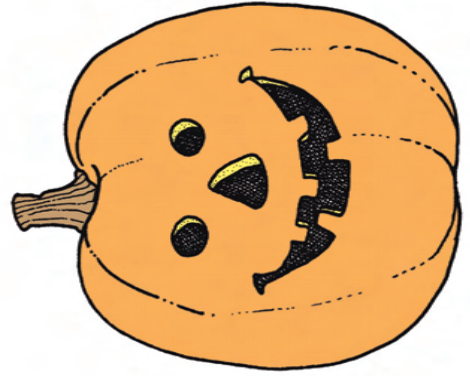
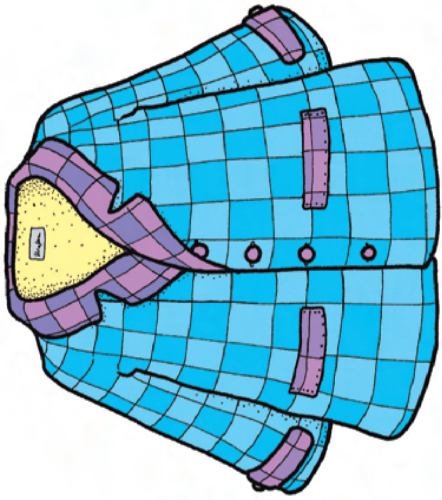

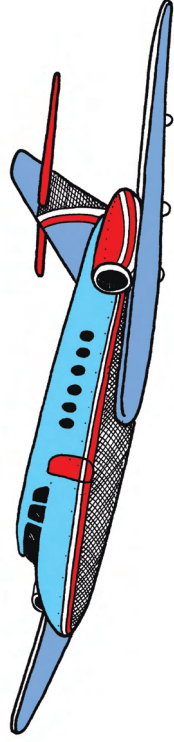
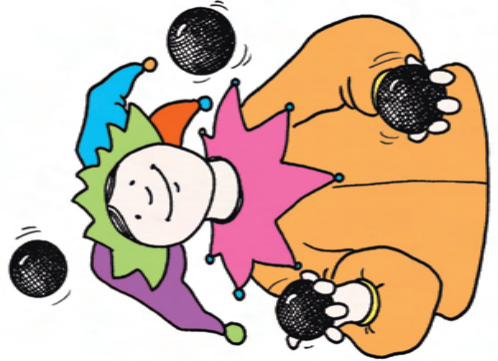
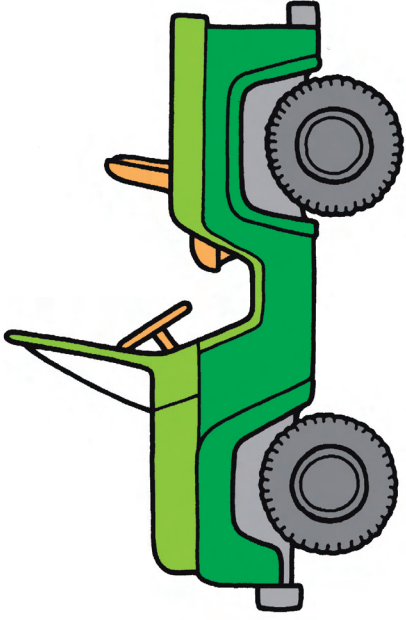
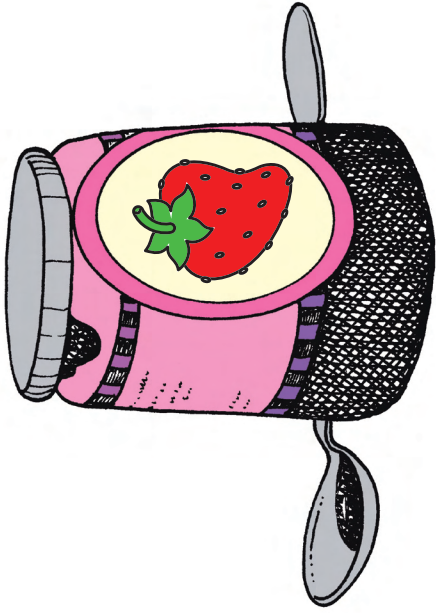

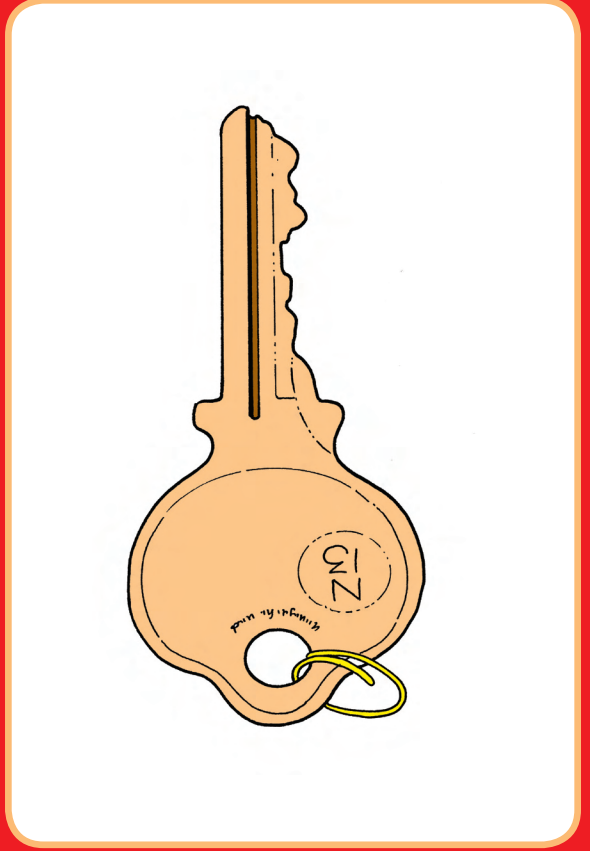
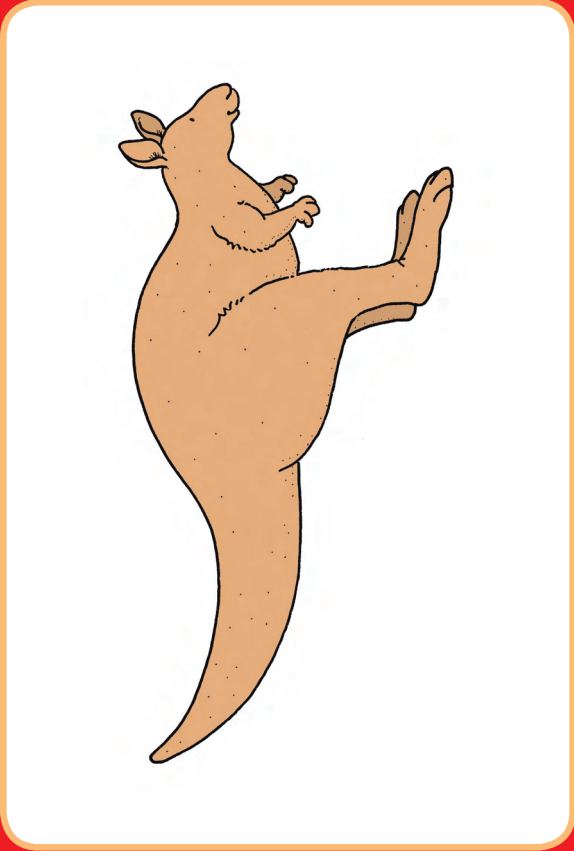

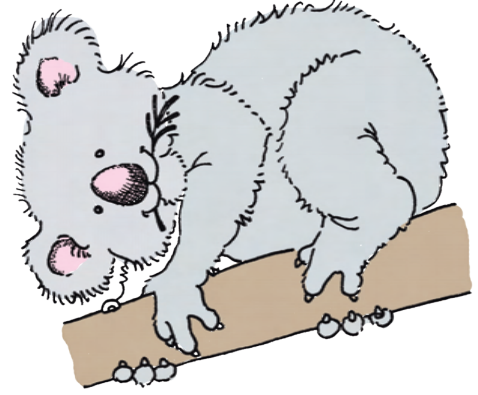
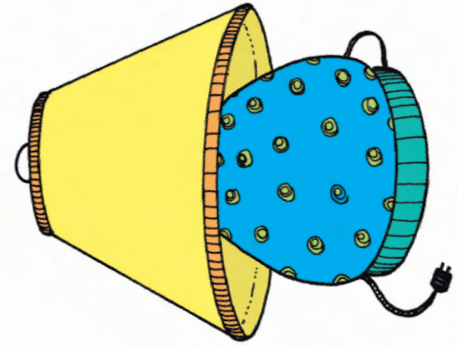
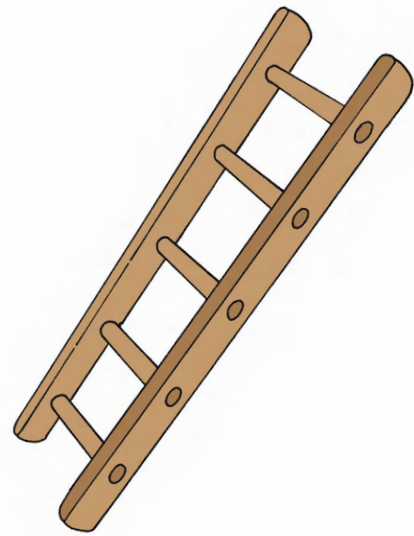

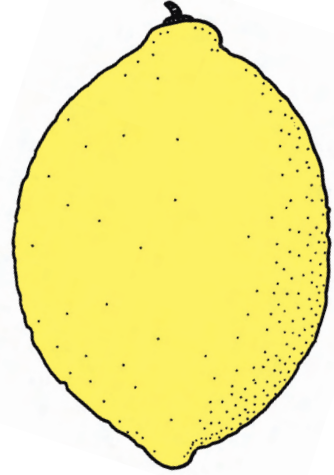
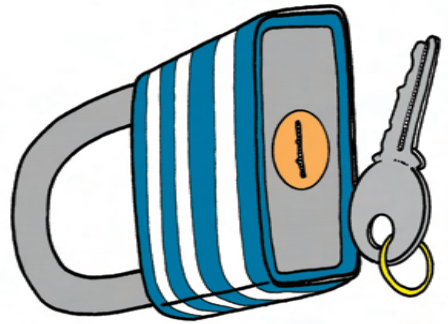
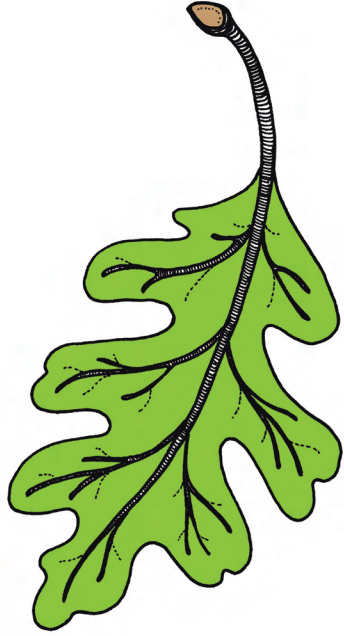
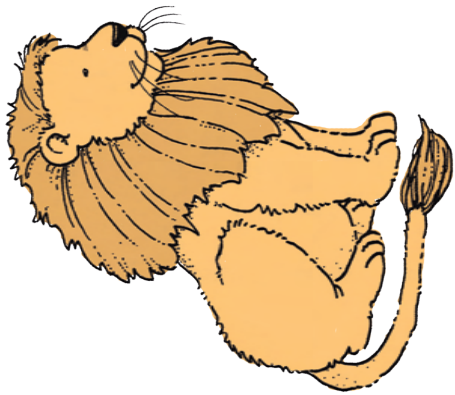

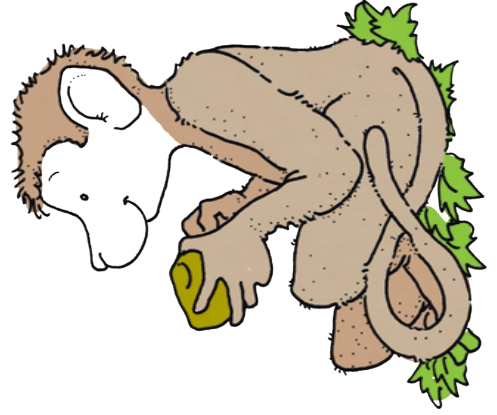
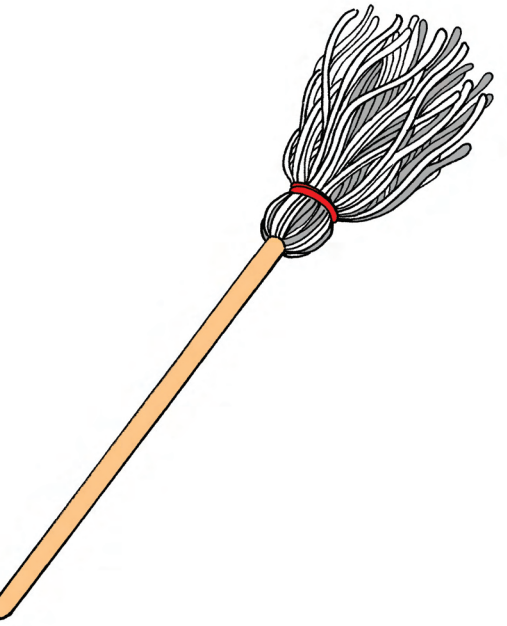
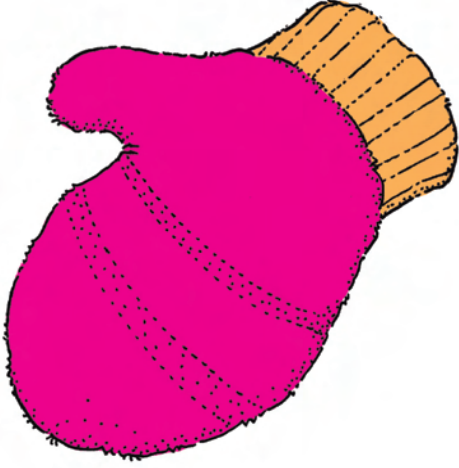
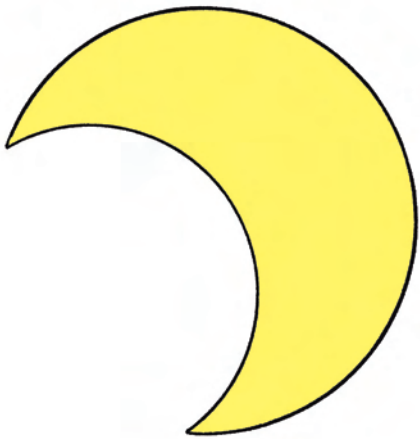

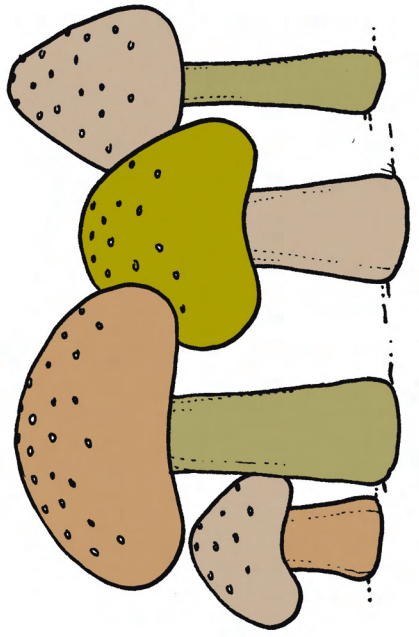
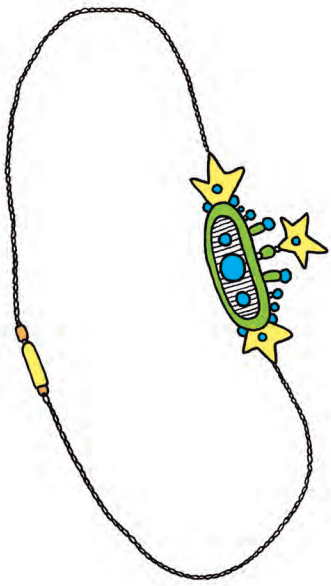

9

1

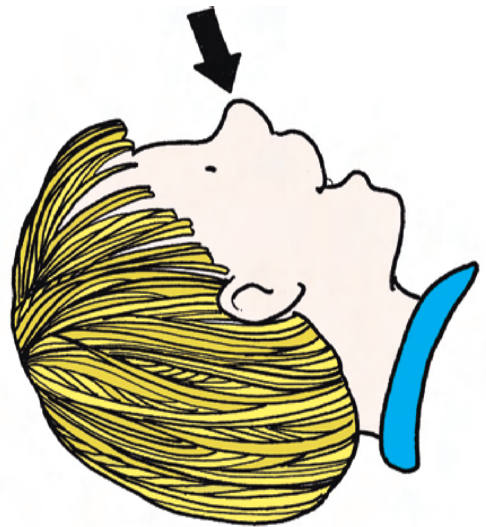
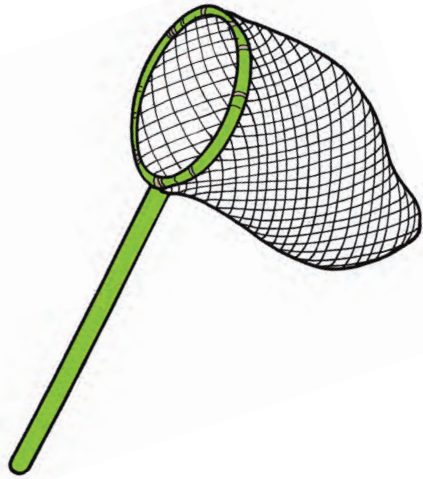

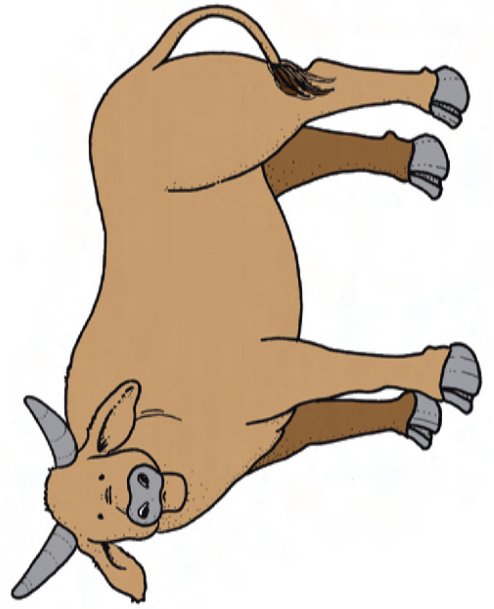
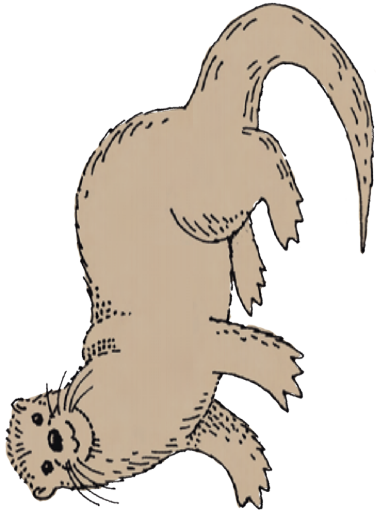
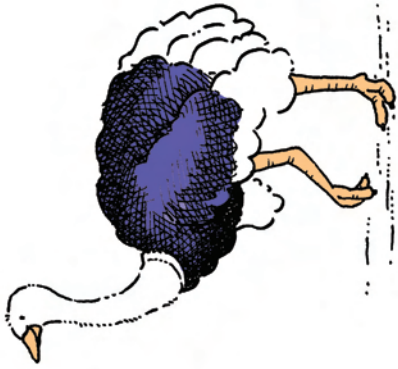

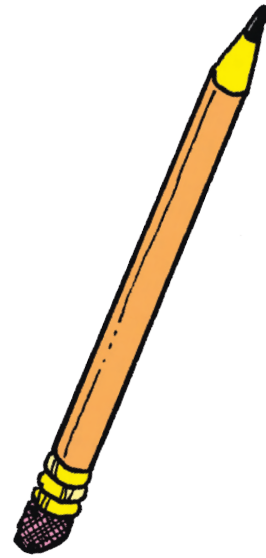
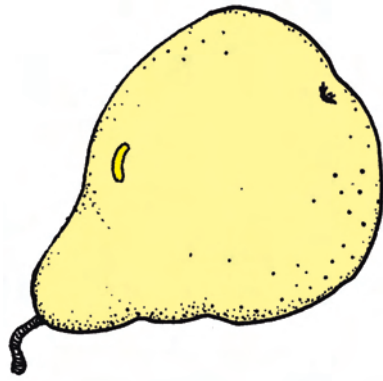
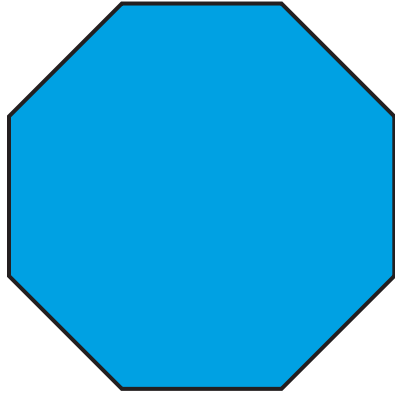

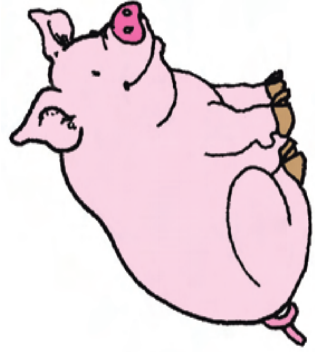
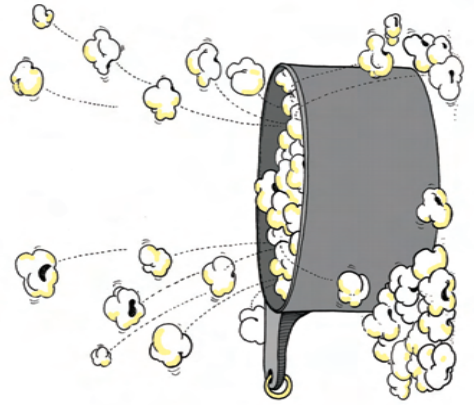
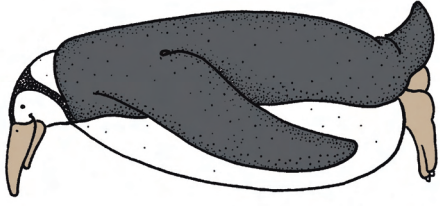

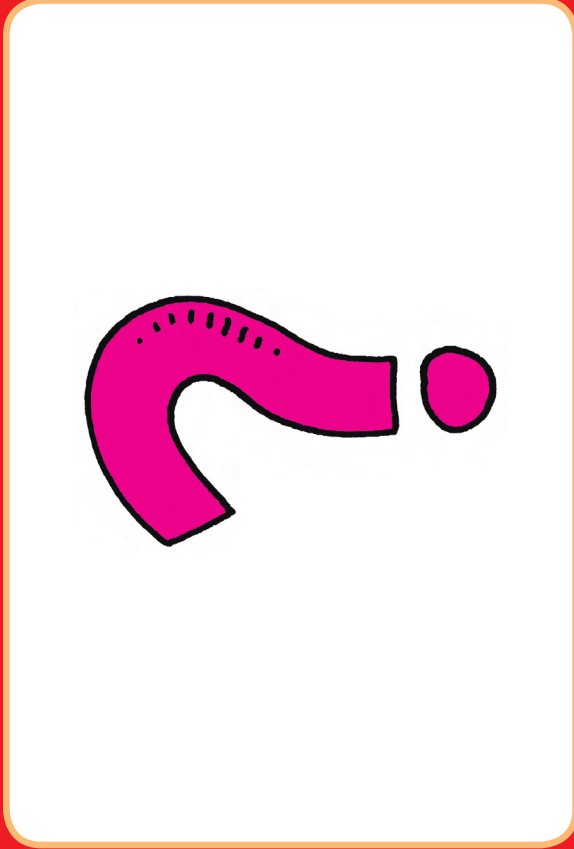
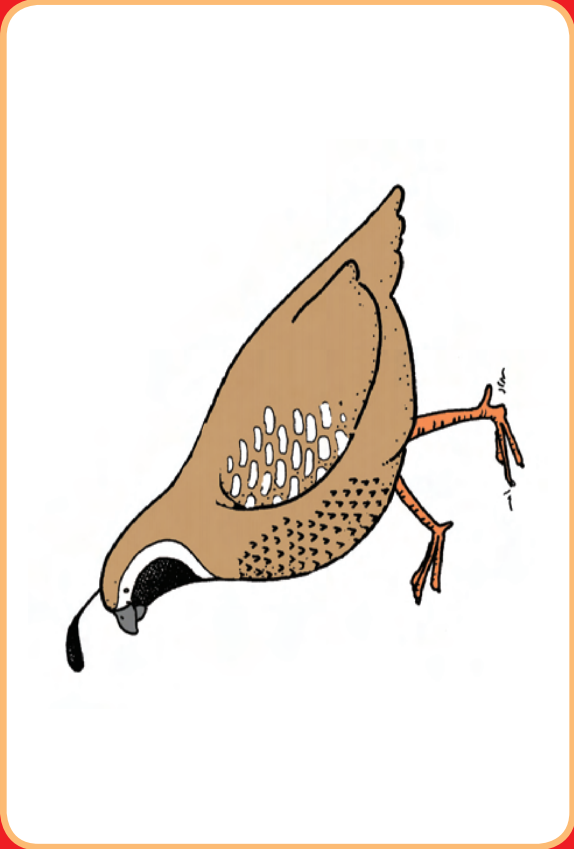

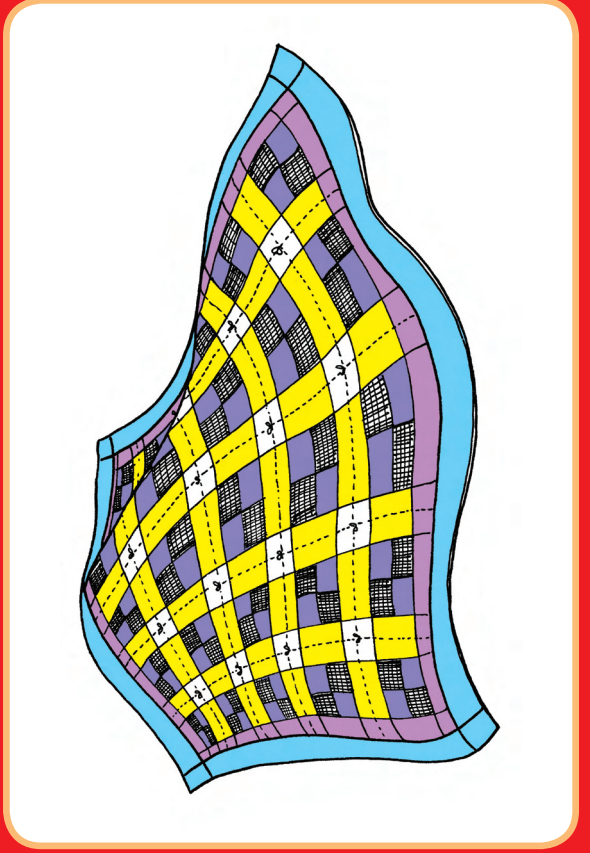
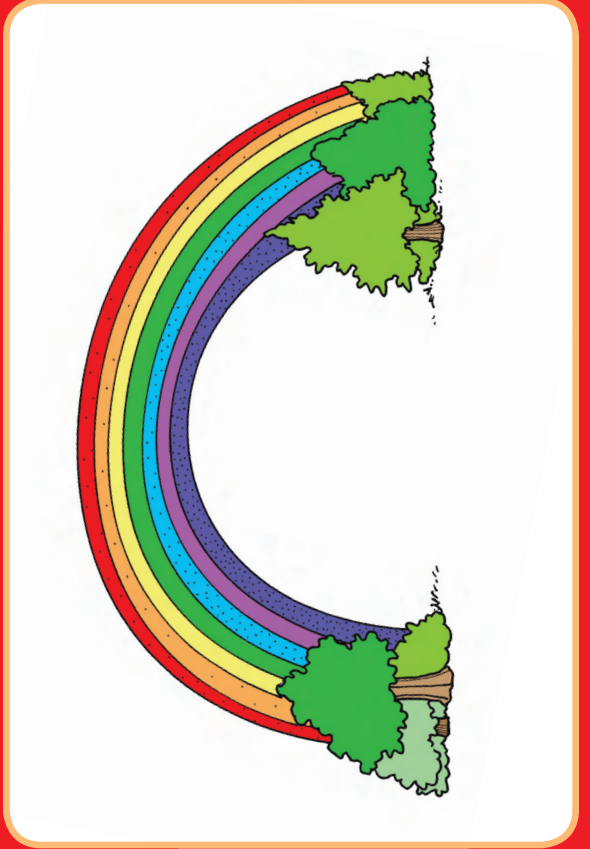
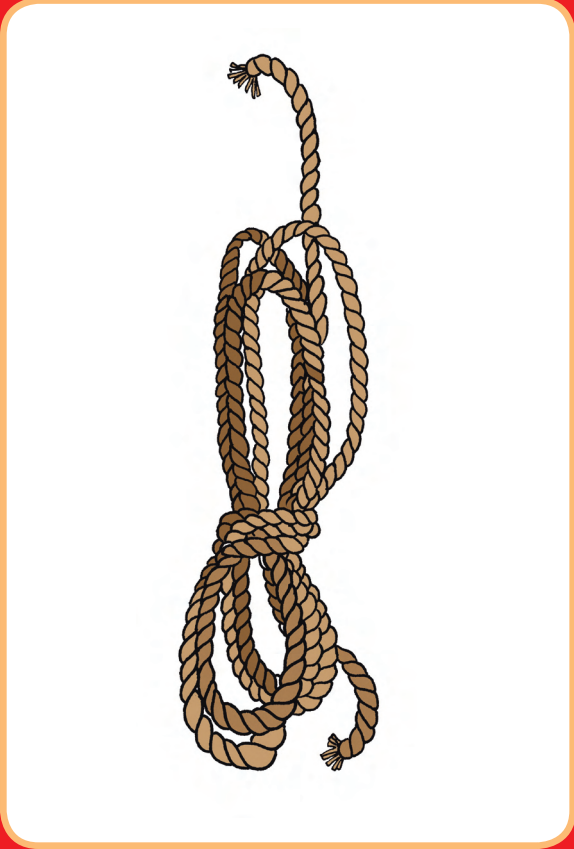

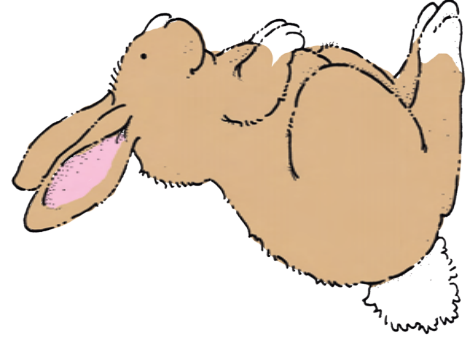
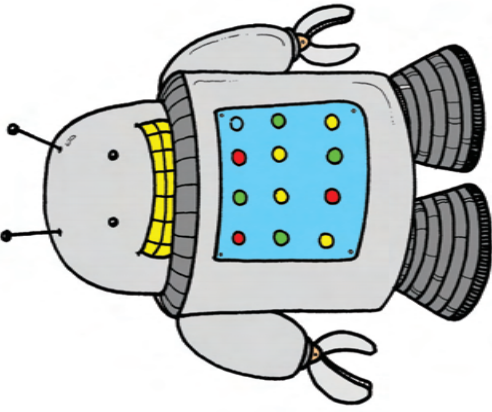

7

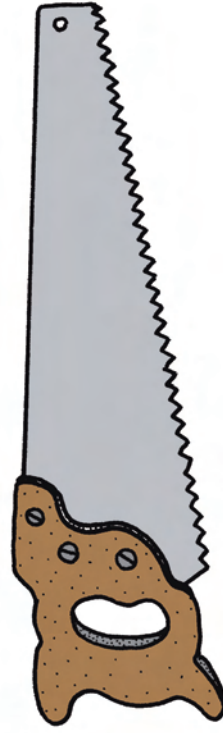
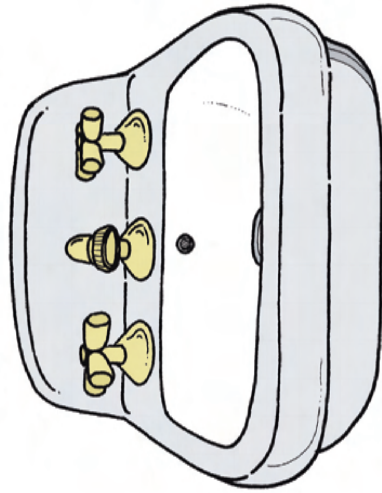
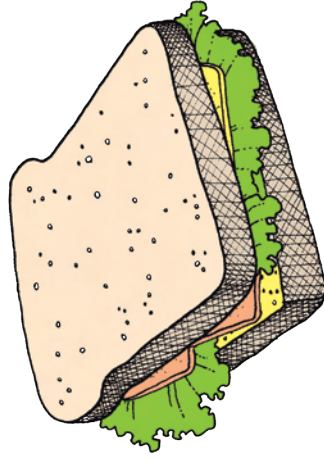

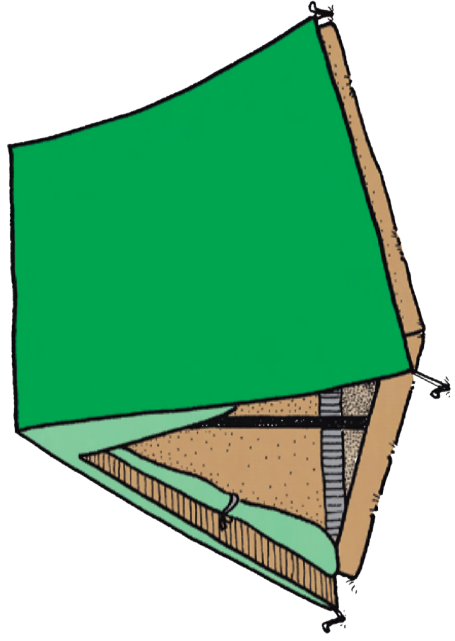
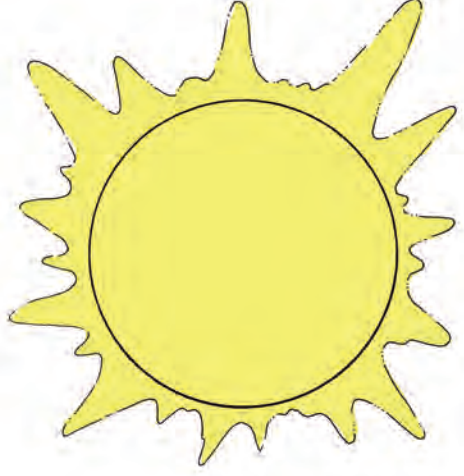
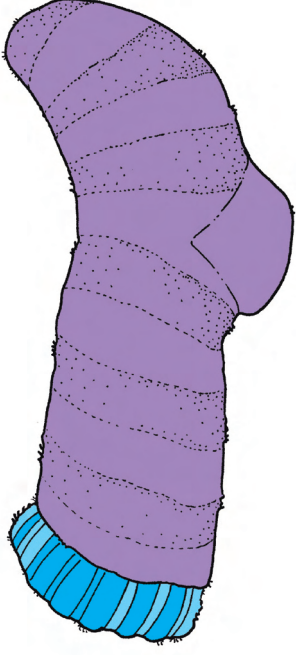
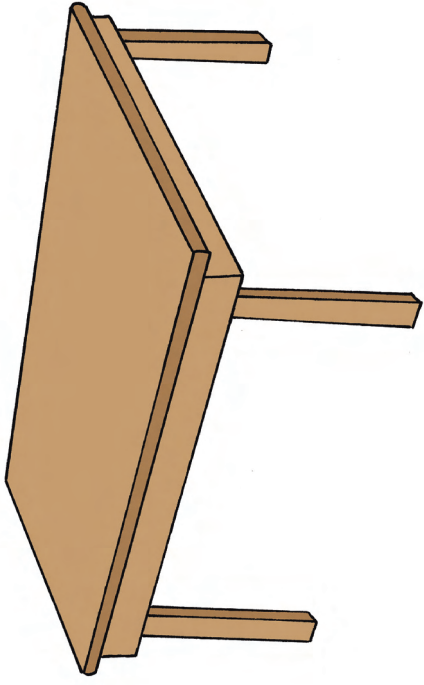

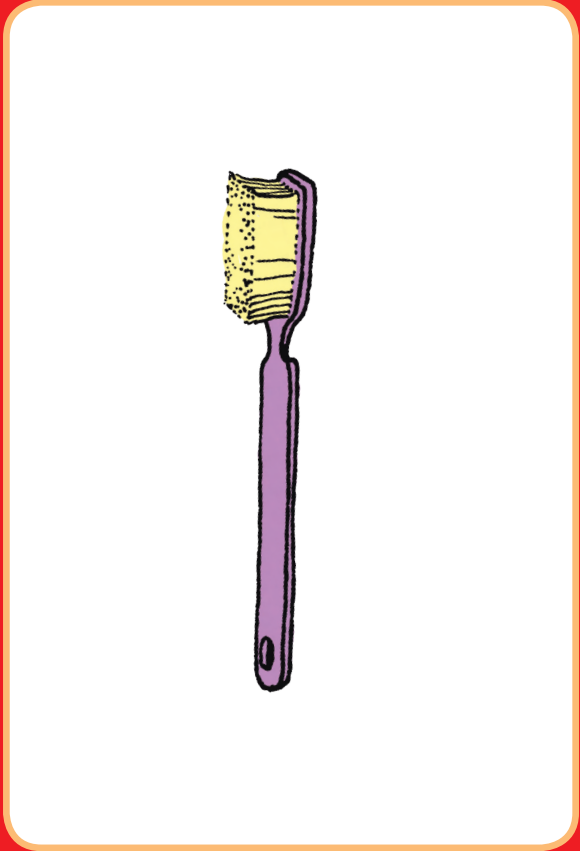
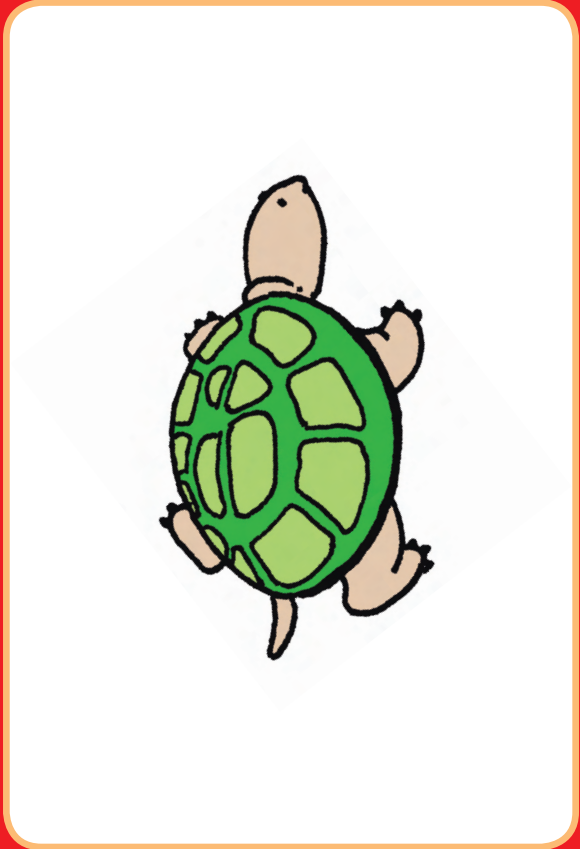
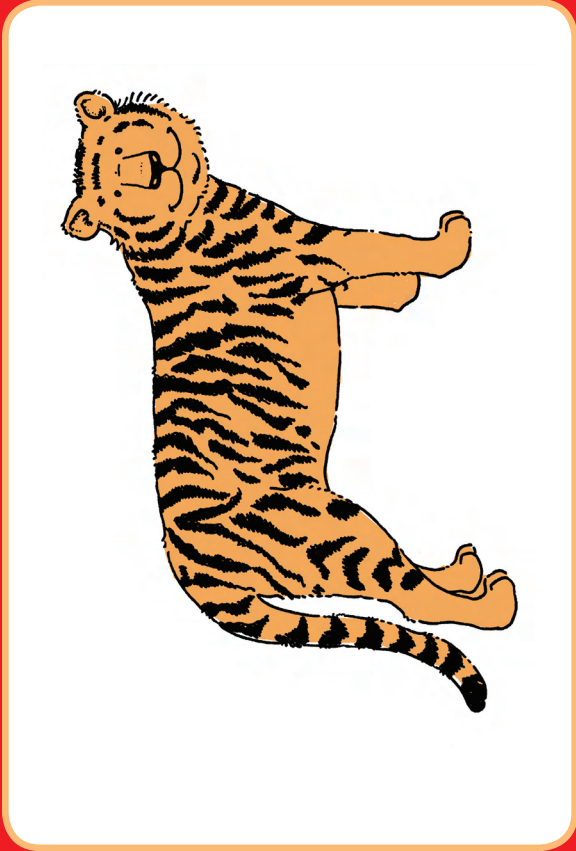

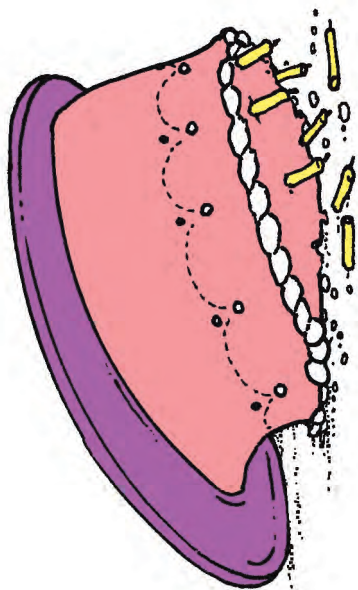
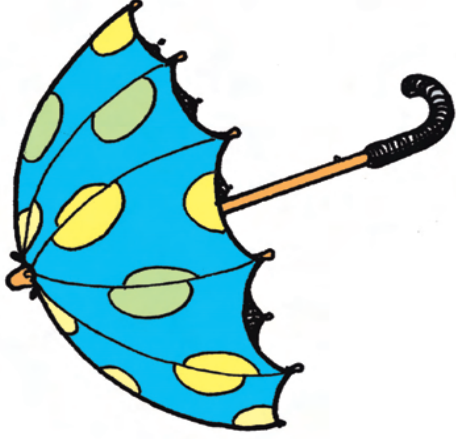
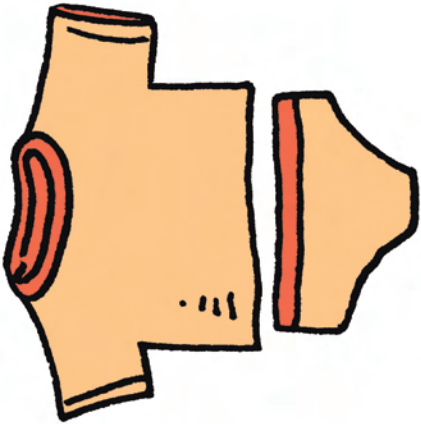

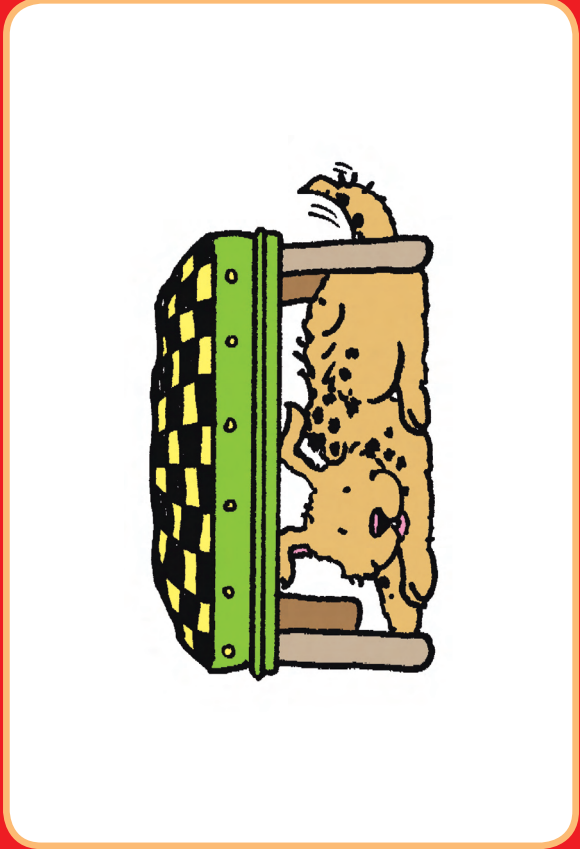
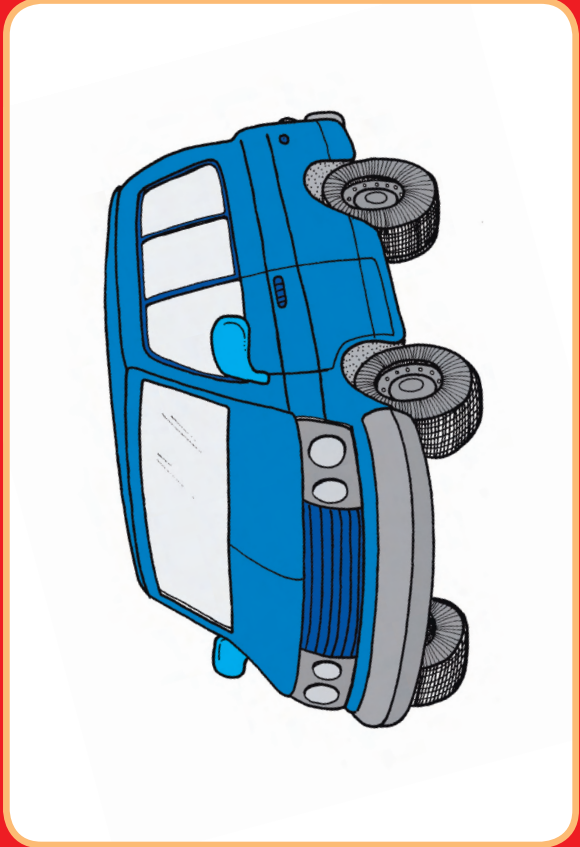
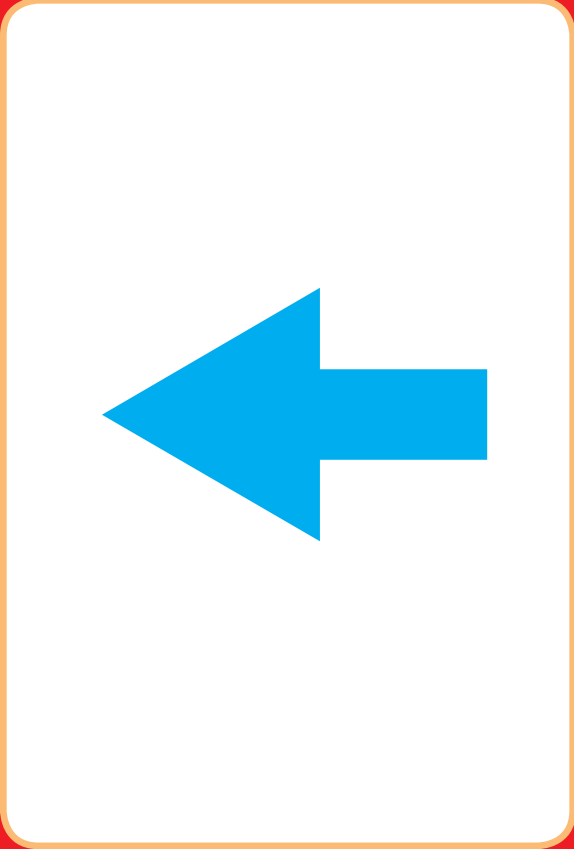
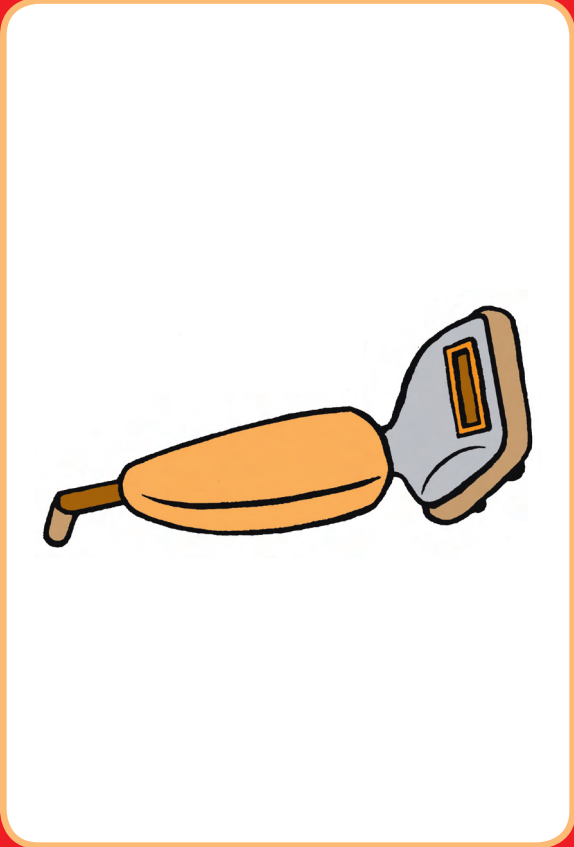

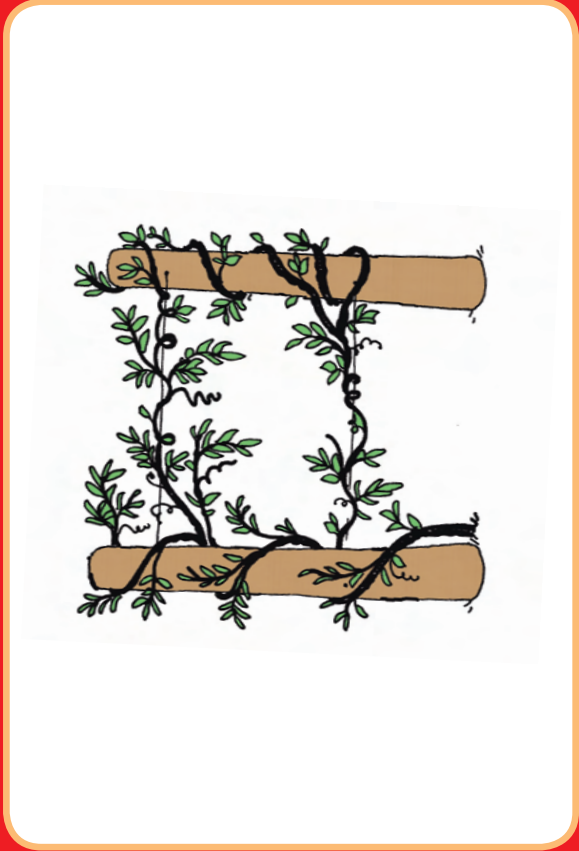
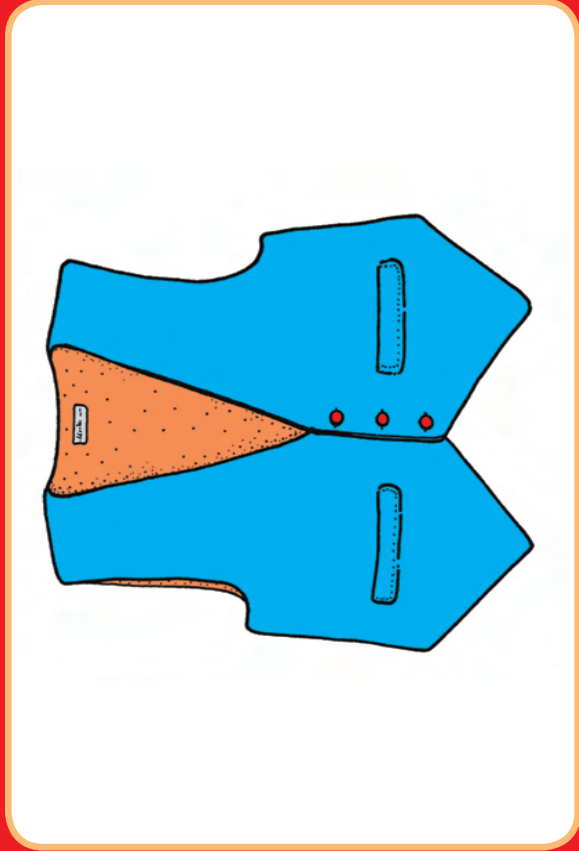

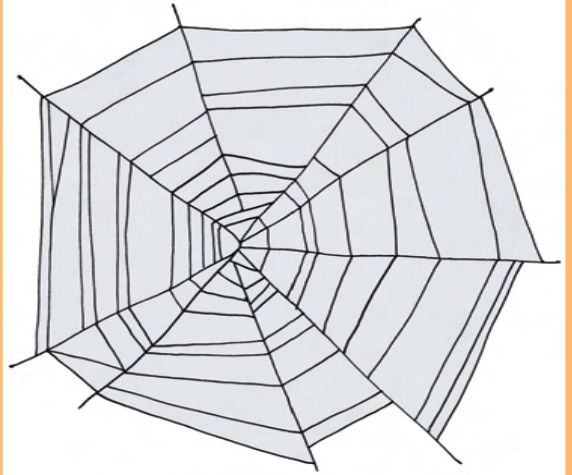
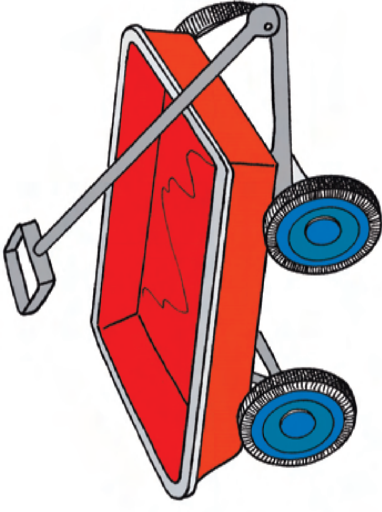
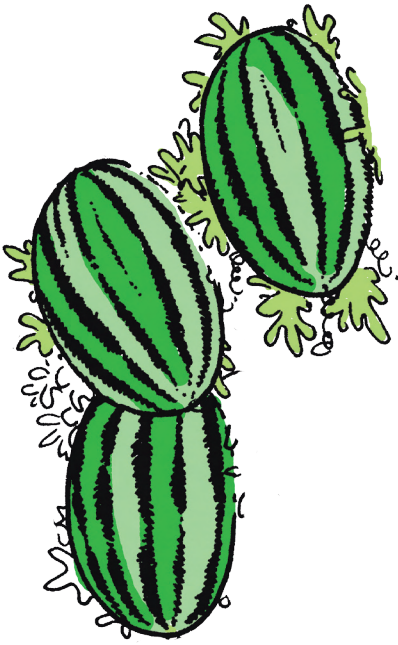

6

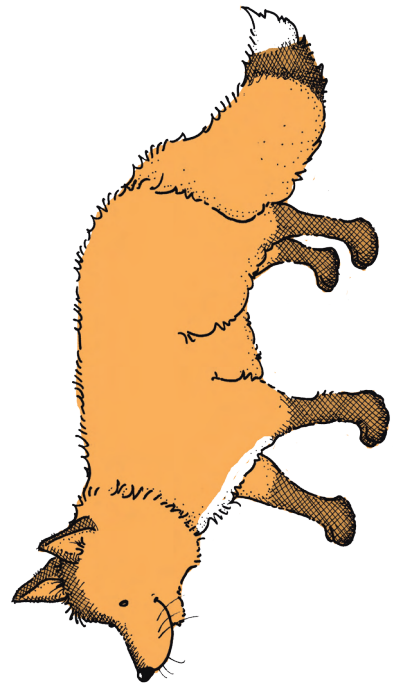
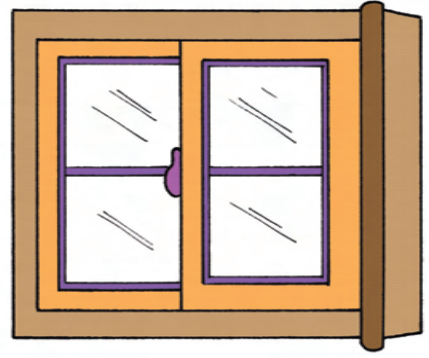
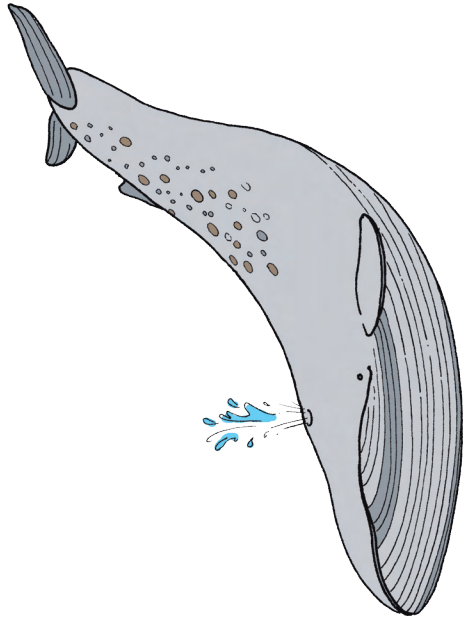

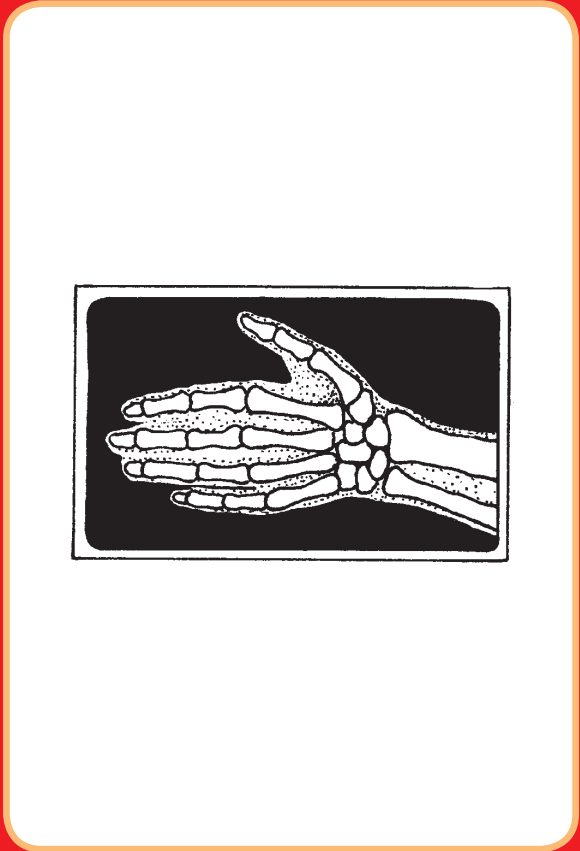
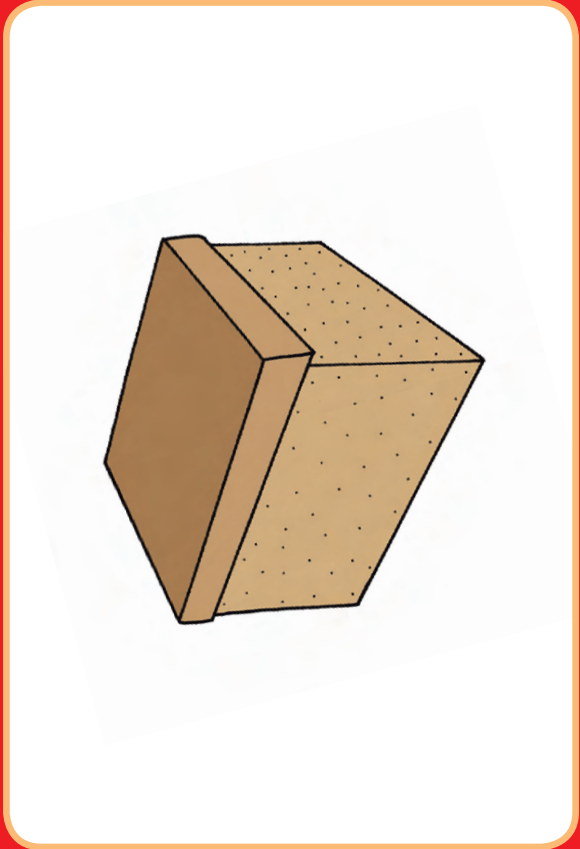
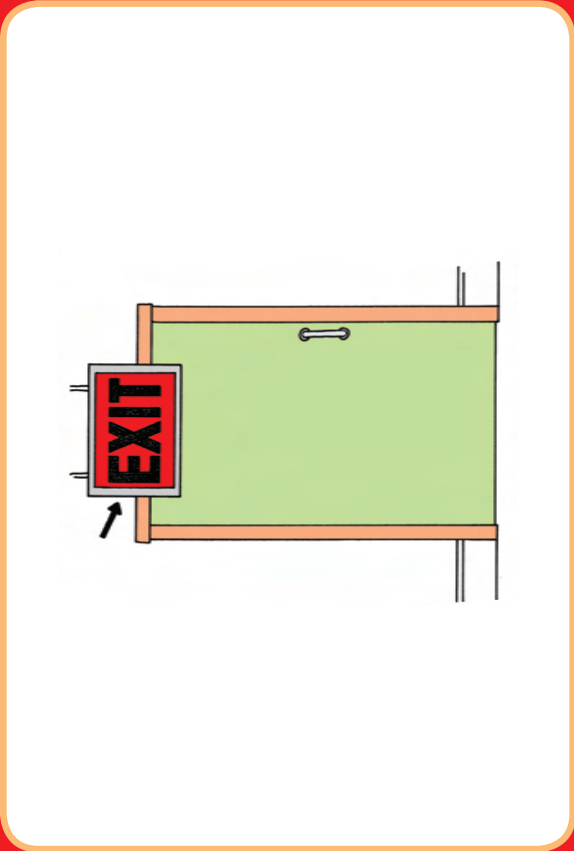

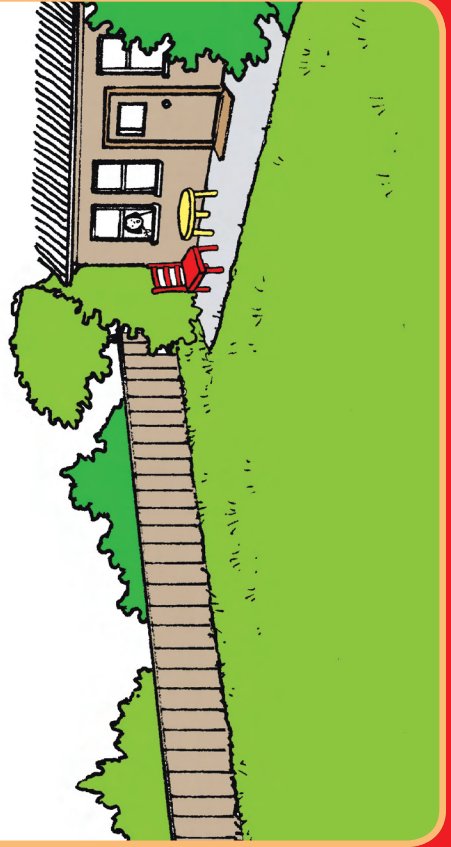
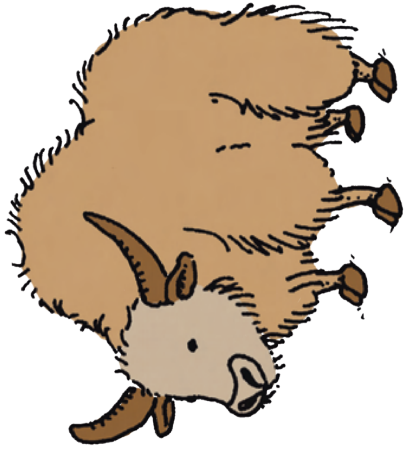
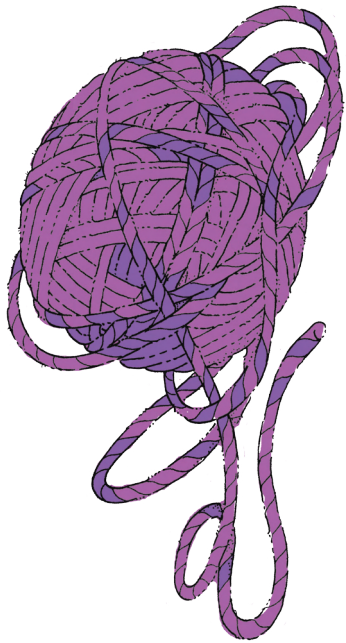

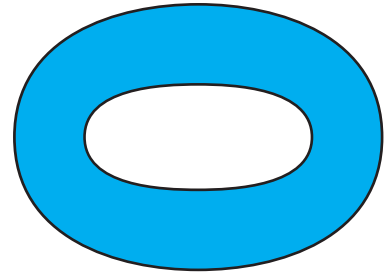
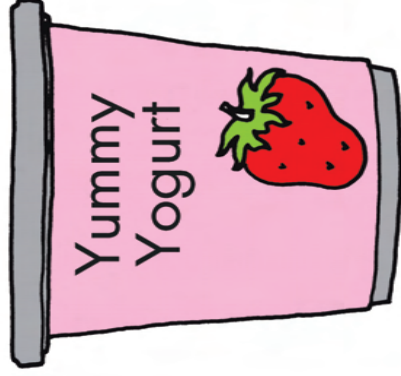

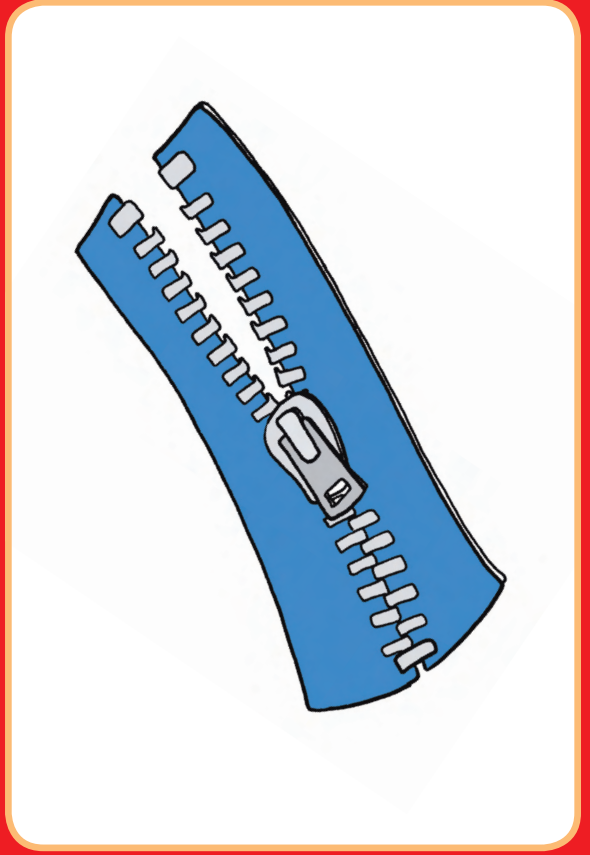
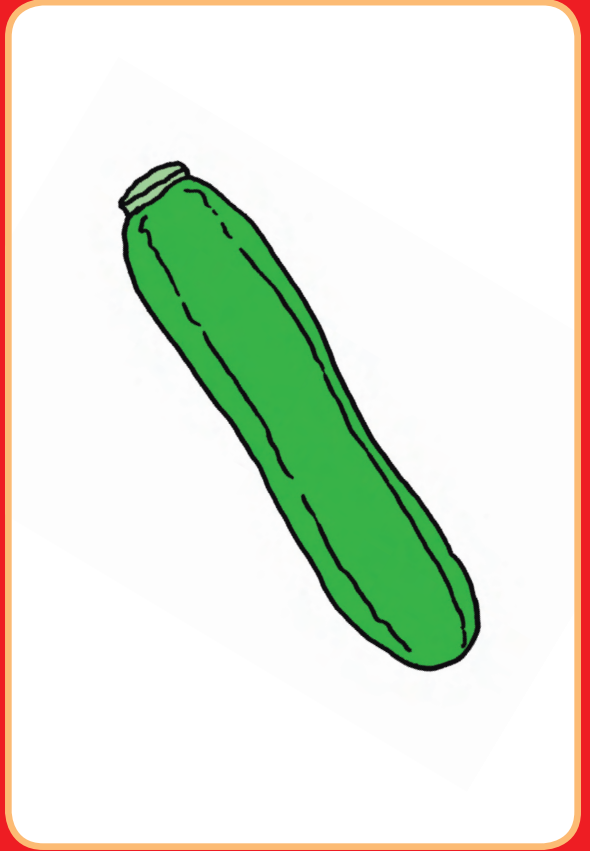
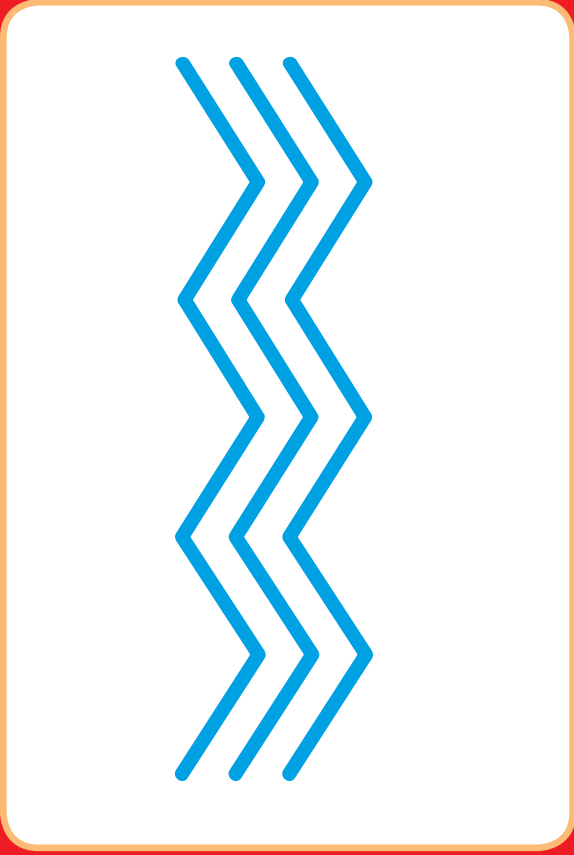
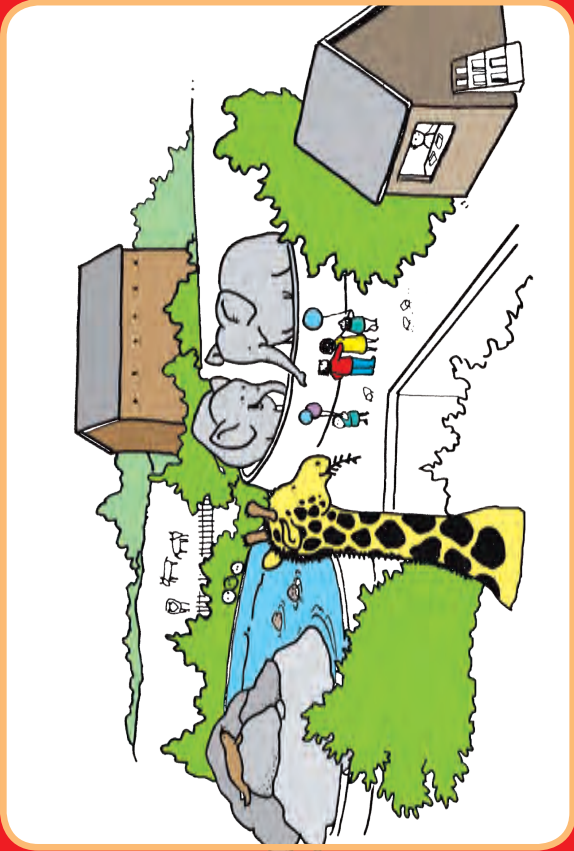

Full-Color
ALPHABET
Picture Cards

The **BIG** Book of **ALPHABET** Activities

Learning the letters and their sounds is as easy as ABC with this big collection of alphabet activities! Easy-to-make mini-books—one for each letter—hands-on activities, and 156 colorful picture cards give kids lots of opportunities to practice letter recognition, letter-sound relationships, and letter-formation skills. Activities include easy games, crafts, snacks, math and literature connections, multisensory experiences, and more. Perfect for use with kids of all learning styles!

Look for these other great books:

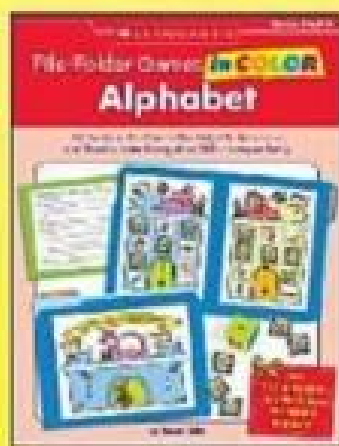

File-Folder Games in Color:
Alphabet
Grades PreK-K
ISBN: 0-439-46591-5

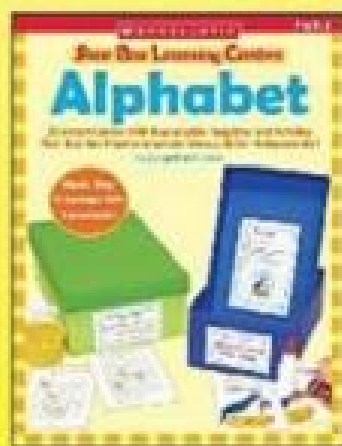

Shoe Box Learning Centers:
Alphabet
Grades PreK-1
ISBN: 0-439-53792-4

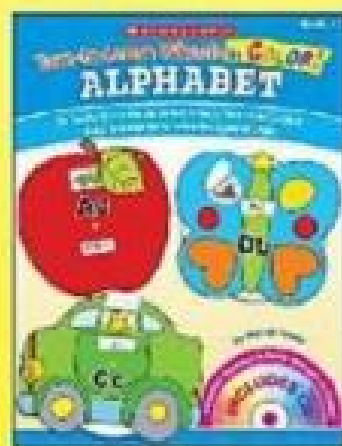

Turn-to-Learn Wheels in Color:
Alphabet
Grades PreK-1
ISBN: 0-439-54322-4

\$29.99 U.S.

SC-513576

**Teaching
Resources**

SCHOLASTIC

The Most Trusted Name in Learning®

www.scholastic.com

